

Bicategories of processes^{*}

P. Katis

School of Mathematics and Statistics, University of Sydney, N.S.W. 2006, Australia

N. Sabadini

Dipartimento di Scienze dell'Informazione, Università di Milano

Via Comelico 39/41, Milano, Italia

R. F. C. Walters

School of Mathematics and Statistics, University of Sydney, N.S.W. 2006, Australia

November 1995

Abstract

The suspension-loop construction is used to define a *process* in a symmetric monoidal category. The algebra of such processes is that of symmetric monoidal bicategories. Processes in categories with products and in categories with sums are studied in detail, and in both cases the resulting bicategories of processes are equipped with operations called *feedback*. Appropriate versions of traced monoidal properties are verified for feedback, and a normal form theorem for expressions of processes is proved. Connections with existing theories of circuit design and computation are established via structure preserving homomorphisms.

^{*}This work has been supported by the Australian Research Council, Esprit BRA AS-MICS, Italian MURST 40% Modelli e Specifiche di Sistemi Concorrenti and the Italian CNR, contract 92.00529.CT01.

1 Introduction

Certain dynamical systems can be tempered to behave as input-output devices. As examples, compare the following two types of input-output systems: a field-effect transistor (FET), for which an input is a gate potential that controls a current flow within the device; and a machine programmed to carry out a specific procedure, for which an input is a datum upon which the procedure acts. In the first example an input can be viewed as an *action* on one part of the device which results in a change of state of the whole system, including the output port. In contrast to this, an input for the programmed machine is an *initial state* of the device, while an output is an equilibrium state which the machine may reach. Clearly, these two examples represent different classes of input-output systems.

In this paper, the notion of a *process* in a symmetric monoidal category is introduced. A *circuit*, which is defined to be a process in a category with products, is intended to model a system such as a FET, while programs, algorithms et cetera are modelled by *Elgot automata* – processes in a category with sums.

The algebra of such processes is that of monoidal bicategories equipped with an operation called feedback. Compact closed categories and Cartesian bicategories ([6]) have been used as a model for circuit design ([11], [4]) as well as a paradigm for the semantics of computation ([1]). Due to the symmetry of the structures there investigated, these models, unlike the one here presented, are unable to treat the asymmetric nature of the roles of input and output in processes.

After presenting some basic definitions in the following two sections, a link is made in Section 4 with the theory of traced monoidal categories ([12]). A normal form theorem for expressions of processes is also proved. Behaviours and equilibrium states of circuits are then defined (via structure preserving homomorphisms), providing precise connections with some existing theories of circuit design. In Section 6, we introduce Elgot automata and briefly discuss the relation with iteration theories ([3]).

The reader may ask: are bicategories, rather than categories, necessary for modelling processes? While the objects of any *abstract* category may be thought of as states, and the arrows as processes, the kinds of processes

discussed above have internal structure and may be compared. As these comparisons naturally arise as 2-cells, the above question must be answered in the affirmative. In most systems it is the internal structure that is interesting. Indeed, complex systems constructed with the operations series, parallel and feedback may have neither input nor output. Bicategories play an essential role in modelling these structures.

2 Processes in a symmetric monoidal category

We begin by defining the suspension-loop construction and apply it to symmetric monoidal categories (\mathbf{C}, \otimes) . This yields a symmetric monoidal bicategory $\Omega\Sigma(\mathbf{C}, \otimes)$, the bicategory of processes in (\mathbf{C}, \otimes) . The notions of infinitesimals and delayed processes are then introduced. For legibility, we write as if our monoidal categories were strict. The symmetry for a tensor will usually be denoted by $c_{X,Y} : X \otimes Y \rightarrow Y \otimes X$.

2.1 The suspension-loop construction

If (\mathbf{C}, \otimes) is a symmetric monoidal category, let $\Sigma(\mathbf{C}, \otimes)$ denote the suspension of (\mathbf{C}, \otimes) , the bicategory with one object, whose 1-cells and 2-cells are the objects arrows of \mathbf{C} respectively, and where horizontal composition is given by the tensor product and vertical composition is the same as the composition of arrows in \mathbf{C} . The structural isomorphisms and functoriality of \otimes guarantee that $\Sigma(\mathbf{C}, \otimes)$ has the identity, associative and middle-four interchange laws. Furthermore, as \otimes is symmetric, it induces a symmetric tensor product on $\Sigma(\mathbf{C}, \otimes)$ which, when there is no cause for ambiguity, is also denoted by \otimes .

Let \mathbf{N} denote the additive monoid of natural numbers, that is, the one object category generated by one arrow. If \mathcal{B} is a bicategory, let $\Omega\mathcal{B}$ denote the bicategory of functors, lax transformations and modifications from \mathbf{N} to \mathcal{B} . (See [2] for more on these and other bicategorical notions.) Explicitly, we have:

- an object of $\Omega\mathcal{B}$ is an endomorphism in \mathcal{B} , $X : a \rightarrow a$;

- an arrow from $X : a \rightarrow a$ to $Y : b \rightarrow b$ is a pair (U, α) , where U is an arrow and α is a 2-cell in \mathcal{B} of the form

$$\begin{array}{ccc}
 a & \xrightarrow{X} & a \\
 U \downarrow & \alpha & \downarrow U \\
 b & \xrightarrow{Y} & b
 \end{array}
 \quad ; \text{ and}$$

- a 2-cell from (U, α) to (V, β) is a 2-cell $\theta : U \rightarrow V$ in \mathcal{B} such that

$$\begin{array}{ccc}
 a & \xrightarrow{X} & a \\
 v \downarrow & \beta & \downarrow v \\
 b & \xrightarrow{Y} & b
 \end{array}
 \quad \theta \quad U
 \quad = \quad
 \begin{array}{ccc}
 a & \xrightarrow{X} & a \\
 \theta \downarrow & \alpha & \downarrow U \\
 b & \xrightarrow{Y} & b
 \end{array}
 .$$

$\Omega\mathcal{B}$ may be thought of as the loop space of \mathcal{B} . As this bicategory is a ‘functor category’, a symmetric tensor on \mathcal{B} induces one on $\Omega\mathcal{B}$ in a natural way.

Definition 1 If (\mathbf{C}, \otimes) is a symmetric monoidal category, the symmetric monoidal bicategory $\Omega\Sigma(\mathbf{C}, \otimes)$ is called the *bicategory of processes* in (\mathbf{C}, \otimes) . An arrow in this bicategory is called a *process* in (\mathbf{C}, \otimes) .

A process $(U, \alpha) : X \rightarrow Y$ is said to have U as its *state-space*, X as its *input* and Y as its *output*; the morphism $\alpha : X \otimes U \rightarrow U \otimes Y$ is referred to as the *dynamics* of the process. The terms X_i and Y_j in the expression

$$(U, \alpha) : X_1 \otimes \dots \otimes X_n \rightarrow Y_1 \otimes \dots \otimes Y_m$$

are respectively called the i^{th} input and the j^{th} output of the process.

2.2 Infinitesimals and delayed processes

An *infinitesimal* is a process whose state-space is I , the unit for \otimes . The arrows in \mathbf{C} which can be constructed from identity arrows using only the structural properties of \otimes are referred to as the *constants* for \otimes . So, the constants in a symmetric monoidal category are those arrows built from identities and symmetries (as well as the unit and associativity isomorphisms, of course) by repetitive application of composition and the tensor product. (So, in giving a constant one gives a family of objects and a permutation of that family.) A *wire* is defined to be an infinitesimal whose dynamics is a constant. If \otimes is a product, the meaning of *constant* is extended so that it refers to arrows which may be built out of identities, symmetries, projections and diagonals. We extend the definition of the term constant in a similar way if the tensor is a sum (that is, we include injections and codiagonals). A wire whose dynamics is a constant built out of only identities and symmetries is called a *permutation wire* (or, merely, a permutation).

The reason why such processes are called infinitesimals will be made clear in Sections 5 and 6, wherein behaviours of processes are defined.

Given a process of the form

$$(U, \alpha) : X_1 \otimes \dots \otimes X_n \rightarrow Y_1 \otimes \dots \otimes Y_m$$

and $i \in [n]$, construct a new process

$$(U, \alpha)_{X_i} : X_1 \otimes \dots \otimes X_n \rightarrow Y_1 \otimes \dots \otimes Y_m,$$

where

$$(U, \alpha)_{X_i} = (X_i \otimes U, (X_i \otimes \alpha) \cdot (c_{X_1 \otimes \dots \otimes X_{i-1}, X_i} \otimes c_{X_{i+1} \otimes \dots \otimes X_n, X_i} \otimes U)).$$

This process is said to have been formed by *delaying* the i^{th} input of (U, α) . Similarly, the process

$${}_{Y_j}(U, \alpha) = (U \otimes Y_j, (U \otimes c_{Y_1 \otimes \dots \otimes Y_{j-1}, Y_j} \otimes c_{Y_{j+1} \otimes \dots \otimes Y_m, Y_j}) \cdot (\alpha \otimes Y_j))$$

is said to have been formed by delaying the j^{th} output of (U, α) . Note that delaying an input or output X of a circuit may be achieved by composition with the circuit $(X, 1_{XX}) : X \rightarrow X$; for example, if (U, α) is a process with input X , $(U, \alpha)_X = (U, \alpha) \cdot (X, 1_{XX})$.

Of course, iterating and combining both procedures may result in processes that have had their inputs and outputs delayed several times. This terminology will be justified in Sections 5 and 6, where it will be shown that processes model devices that can store both inputs and outputs for set periods of time.

The following two evident propositions relate composition and tensor product with delays.

Proposition 1 *Let*

$$(U, \alpha) : X \rightarrow Y_1 \otimes \dots \otimes Y_m \text{ and } (V, \beta) : Y_1 \otimes \dots \otimes Y_m \rightarrow Z$$

be processes. Then for all $i \in [m]$ the unit and associativity isomorphisms of \otimes yield the following natural isomorphisms:

1. $(V, \beta) \cdot_{Y_i}(U, \alpha) \cong (V, \beta)_{Y_i} \cdot (U, \alpha)$;
2. $z(V, \beta) \cdot (U, \alpha) \cong z((V, \beta) \cdot (U, \alpha))$; and
3. $(V, \beta) \cdot (U, \alpha)_X \cong ((V, \beta) \cdot (U, \alpha))_X$.

Proposition 2 *Let $(U, \alpha) : X_1 \otimes \dots \otimes X_n \rightarrow Y_1 \otimes \dots \otimes Y_m$ and $(V, \beta) : A \rightarrow B$ be processes. Then for all $i \in [n]$ and $j \in [m]$ we have the following natural isomorphisms:*

1. $(U, \alpha)_{X_i} \otimes (V, \beta) \cong ((U, \alpha) \otimes (V, \beta))_{X_i}$; and
2. ${}_{Y_j}(U, \alpha) \otimes (V, \beta) \cong {}_{Y_j}((U, \alpha) \otimes (V, \beta))$.

3 Circuits

An operation fb , which is an abbreviation of the word feedback, is defined for bicategories of processes in categories with products. We then construct diagrams for expressions in such bicategories. Finally, some brief remarks are made regarding the connection between these processes and dynamical systems.

We adopt the following conventions when working in categories with products. If A and B are objects and f is an arrow, AB and Af denote $A \times B$

and $1_A \times f$ respectively. Given a family of maps $(x_i : S \rightarrow X_i)_{i \in [n]}$, where n is a natural number, $(x_1, \dots, x_n) : S \rightarrow X_1 \dots X_n$ denotes the unique map defined by the universal property of products. Furthermore, a composite of the form $f \cdot (x_1, \dots, x_n)$ will often be written as just $f(x_1, \dots, x_n)$. If $\phi : [j] \rightarrow [n]$ is an injective function, we will write $p_{X_{\phi(1)} \dots X_{\phi(j)}} : X_1 \dots X_n \rightarrow X_{\phi(1)} \dots X_{\phi(j)}$ for the obvious composite of symmetries and a projection (except, of course, in those circumstances where this notation would be ambiguous).

3.1 Feedback of circuits

If \mathbf{C} is a category with finite products, write $\mathbf{Circ}(\mathbf{C})$ for $\Omega\Sigma(\mathbf{C}, \times)$. A process in (\mathbf{C}, \times) is also called a *circuit* in \mathbf{C} .

Suppose $(U, \alpha) : X \otimes Y \rightarrow Z \otimes Y$ is a circuit in \mathbf{C} with the property that there exists $\tau : XU \rightarrow Y$ such that the diagram

$$XU \xrightarrow{(Xc_{U,Y}) \cdot (1_{XU}, \tau)} XYU \begin{array}{c} \xrightarrow{p_Y \cdot \alpha} \\ \xrightarrow{p'_Y} \end{array} Y$$

is an equalizer in \mathbf{C} where $p'_Y : XYU \rightarrow Y$ and $p_Y : ZYU \rightarrow Y$ are projections. (Note that there can exist at most one map τ satisfying this condition.) In this case we say Y can be *fed back* in (U, α) ; also, τ is called the *structure map* for feeding back Y in the circuit. For any triple of objects X, Y and Z in \mathbf{C} , define $(\mathbf{C}, \times)_{X,Z}^Y$ to be the full subcategory of $\mathbf{Circ}(\mathbf{C})(X \otimes Y, Z \otimes Y)$ consisting of those circuits which have a structure map for feeding back Y .

Definition 2 The functor $\text{fb}(\mathbf{C}, \times)_{X,Z}^Y : (\mathbf{C}, \times)_{X,Z}^Y \rightarrow \mathbf{Circ}(\mathbf{C})(X, Z)$ is specified as follows.

- If $(U, \alpha) \in \text{ob}((\mathbf{C}, \times)_{X,Z}^Y)$ has a structure map τ for feeding back Y ,
 $\text{fb}(\mathbf{C}, \times)_{X,Z}^Y(U, \alpha) = (U, p_{UZ} \cdot \alpha \cdot (Xc_{U,Y}) \cdot (1_{XU}, \tau)) \in \mathbf{Circ}(\mathbf{C})(X, Z)$.
- If $(U, \alpha), (V, \beta) \in \text{ob}((\mathbf{C}, \times)_{X,Z}^Y)$ and $\theta : U \rightarrow V$ defines a 2-cell from (U, α) to (V, β) in $\mathbf{Circ}(\mathbf{C})$, $\theta : U \rightarrow V$ will also define a 2-cell from $\text{fb}(\mathbf{C}, \times)_{X,Z}^Y(U, \alpha)$ to $\text{fb}(\mathbf{C}, \times)_{X,Z}^Y(V, \beta)$.

To see that this last statement is true, let us first consider the diagram

$$\begin{array}{ccccc}
XU & \xrightarrow{(Xc_{U,Y}) \cdot (1_{XU}, \tau)} & XYU & \xrightarrow[p'_Y \cdot \alpha]{} & Y \\
& & \downarrow XY\theta & & \downarrow 1_Y \\
XV & \xrightarrow{(Xc_{V,Y}) \cdot (1_{XV}, \sigma)} & XYV & \xrightarrow[p'_Y \cdot \beta]{} & Y
\end{array}$$

where τ and σ are the structure maps for feeding back Y in (U, α) and (V, β) respectively.

The condition that $\theta : U \rightarrow V$ defines a 2-cell from (U, α) to (V, β) is

$$(\theta ZY) \cdot \alpha = \beta \cdot (XY\theta). \quad (1)$$

Therefore,

$$\begin{aligned}
p'_Y \cdot \beta \cdot (XY\theta) &= p'_Y \cdot (\theta ZY)\alpha \\
&= p_Y \cdot \alpha.
\end{aligned}$$

We also have that $p'_Y \cdot (XY\theta) = p_Y$. These last two results, when combined with the fact that the top and bottom lines of the above diagram are equalizers, imply the existence of a unique $\chi : XU \rightarrow XV$ satisfying the equation

$$(XY\theta) \cdot (Xc_{U,Y}) \cdot (1_{XU}, \tau) = (Xc_{V,Y}) \cdot (1_{XV}, \sigma) \cdot \chi. \quad (2)$$

If (x, u) is any arrow into XU ,

$$(XY\theta) \cdot (Xc_{U,Y}) \cdot (1_{XU}, \tau)(x, u) = (x, \tau(x, u), \theta(u)),$$

and

$$(1_{XV}, \sigma) \cdot \chi(x, u) = (\chi(x, u), \sigma \cdot \chi(x, u)).$$

So by equation 2, $\chi(x, u) = (x, \theta(u))$ and $\tau(x, u) = \sigma(\chi(x, u))$. That is,

$$\chi = X\theta \quad \text{and} \quad \tau = \sigma \cdot \chi = \sigma \cdot (X\theta). \quad (3)$$

Also note,

$$\begin{aligned}
(X\theta Y) \cdot (1_{XU}, \sigma \cdot (X\theta))(x, u) &= (x, \theta(u), \sigma(x, \theta(x, u))) \\
&= (1_{XV}, \sigma) \cdot (X\theta)(x, u).
\end{aligned}$$

Finally,

$$\begin{aligned}
& (\theta Z) \cdot p_{UZ} \cdot \alpha \cdot (Xc_{U,Y}) \cdot (1_{XU}, \tau) \\
&= p_{VZ} \cdot (\theta ZY) \cdot \alpha \cdot (Xc_{U,Y}) \cdot (1_{XU}, \sigma \cdot (X\theta)) \quad (\text{by 3}) \\
&= p_{VZ} \cdot \beta \cdot (XY\theta) \cdot (Xc_{U,Y}) \cdot (1_{XU}, \sigma \cdot (X\theta)) \quad (\text{by 1}) \\
&= p_{VZ} \cdot \beta \cdot (Xc_{V,Y}) \cdot (X\theta Y) \cdot (1_{XU}, \sigma \cdot (X\theta)) \\
&= p_{VZ} \cdot \beta \cdot (Xc_{V,Y}) \cdot (1_{XV}, \sigma) \cdot (X\theta) \quad (\text{by 4}).
\end{aligned}$$

Thus θ defines a 2-cell from $\text{fb}(\mathbf{C}, \times)_{X,Z}^Y(U, \alpha)$ to $\text{fb}(\mathbf{C}, \times)_{X,Z}^Y(V, \beta)$. Clearly, $\text{fb}(\mathbf{C}, \times)_{X,Z}^Y$ is functorial. If there is no cause for ambiguity, $\text{fb}(\mathbf{C}, \times)_{X,Z}^Y$ will be written as $\text{fb}_{X,Z}^Y$.

So the symmetric monoidal bicategory $\mathbf{Circ}(\mathbf{C})$ can be equipped with a family of partially defined functors

$$\text{fb}_{X,Z}^Y : \mathbf{Circ}(\mathbf{C})(X \otimes Y, Z \otimes Y) \rightarrow \mathbf{Circ}(\mathbf{C})(X, Z).$$

The reader is reminded that in [12] a trace for a balanced monoidal category \mathcal{V} was defined to be a natural family of functions

$$\text{Tr}_{X,Z}^Y : \mathcal{V}(X \otimes Y, Z \otimes Y) \rightarrow \mathcal{V}(X, Z)$$

satisfying three axioms. In the next section, we will show that feedback satisfies the defining properties of a trace, with the equations being replaced by natural isomorphisms. In fact, for suitable \mathbf{C} , $\mathbf{Circ}(\mathbf{C})$ is a locally-full sub-bicategory of a compact closed bicategory. (This fact will be treated in a future paper.)

There are enough equalizers in categories with products so that suitably delayed circuits can be fed back. Given $(U, \alpha) : X \otimes Y \rightarrow Z \otimes Y$, it is clear that $p_Y \cdot \alpha : XYU \rightarrow Y$ will be the structure map for feeding back Y in $(U, \alpha)_Y$. Also $p'_Y : XUY \rightarrow Y$ will be the structure map for feeding back Y in ${}_Y(U, \alpha)$. We leave to the reader the verification of

Proposition 3 *For any $(U, \alpha) : X \otimes Y \rightarrow Z \otimes Y$, $c_{Y,U} : YU \rightarrow UY$ defines a natural isomorphism*

$$\begin{aligned}
\text{fb}_{X,Z}^Y((U, \alpha)_Y) &= (YU, c_{UZ,Y} \cdot \alpha) \\
&\cong (UY, (Uc_{Z,Y}) \cdot \alpha \cdot (Xc_{U,Y})) \\
&= \text{fb}_{X,Z}^Y({}_Y(U, \alpha)).
\end{aligned}$$

Another operation, which might be called feedback, can be defined for processes in any symmetric monoidal category as follows:

$$\begin{aligned} \text{feedback}_{\otimes} &: \Omega\Sigma(\mathbf{C}, \otimes)(X \otimes Y, Y \otimes Z) \rightarrow \Omega\Sigma(\mathbf{C}, \otimes)(X, Z) \\ &: (U, \alpha) \mapsto (Y \otimes U, (c_{U,Y} \otimes Z) \cdot \alpha). \end{aligned}$$

If $(U, \alpha) : X \otimes Y \rightarrow Y \otimes Z$ is a circuit,

$$\text{feedback}_{\otimes}(U, \alpha) = \text{fb}_{X,Z}^Y((U, (Uc_{Y,Z}) \cdot \alpha)_Y).$$

Though this more general feedback operation is important (and may, in fact, be treated in a very elegant fashion), it will not be studied independently in this paper. We should remark that $\text{feedback}_{\otimes}$ does not satisfy all the axioms for a trace.

3.2 Circuit diagrams

The advantages of being able to draw diagrams for expressions in monoidal categories have long been recognized. *Circuit diagrams* – diagrams associated to expressions of circuits – are to be read from left to right (unlike the string diagrams depicted in [12]).

A circuit of the form $(U, \alpha) : X_1 \otimes \dots \otimes X_n \rightarrow Y_1 \otimes \dots \otimes Y_m$ is represented by the diagram

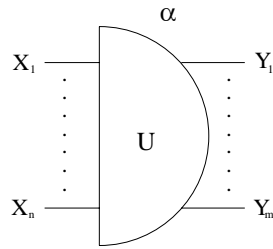

In the following table circuit diagrams have been drawn for all the operations discussed so far.

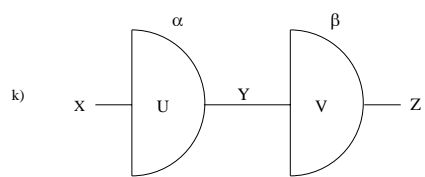
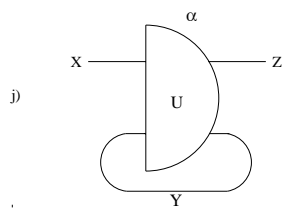
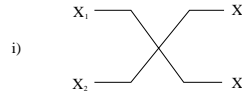
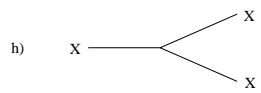
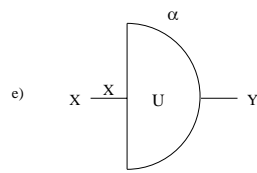
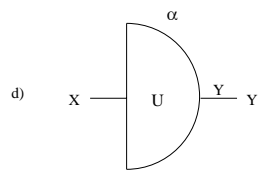
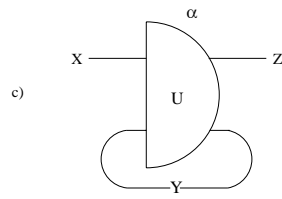
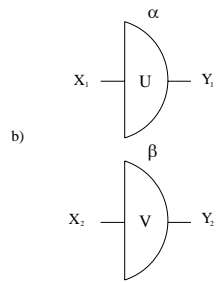
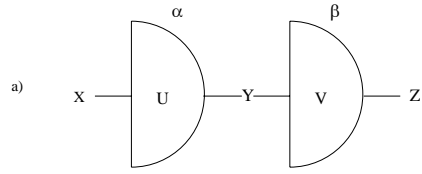

The expressions corresponding to the diagrams in the table are:

- (a) $(V, \beta) \cdot (U, \alpha)$, where $(U, \alpha) : X \rightarrow Y$ and $(V, \beta) : Y \rightarrow Z$;
- (b) $(U, \alpha) \otimes (V, \beta)$, where $(U, \alpha) : X_1 \rightarrow Y_1$ and $(V, \beta) : X_2 \rightarrow Y_2$;
- (c) $\text{fb}_{X,Z}^Y(U, \alpha)$;
- (d) ${}_Y(U, \alpha) : X \rightarrow Y$;
- (e) $(U, \alpha)_X : X \rightarrow Y$;
- (f) $(I, 1_X) : X \rightarrow X$;
- (g) $(I, p_I) : X \rightarrow I$;
- (h) $(I, \Delta_X) : X \rightarrow X \otimes X$;
- (i) $(I, c_{X_1, X_2}) : X_1 \otimes X_2 \rightarrow X_2 \otimes X_1$;
- (j) $\text{fb}_{X,Z}^Y(U, \alpha)_Y : X \rightarrow Z$; and,
- (k) $(V, \beta)_Y \cdot (U, \alpha)$, where $(U, \alpha) : X \rightarrow Y$ and $(V, \beta) : Y \rightarrow Z$.

Notice that, in the above diagrams, there are two types of labels associated with wires: letters at the same level as the wires – for example, the letters X , Y and Z in the figure a); and letters above the wires which denote delays, as in figures d) and e). The diagrams j) and k) have been included to indicate that wires need not be labelled twice. Furthermore, when drawing composites of wires there is no need for an indication of the domain and codomain of each term in the expression.

3.3 Circuits and dynamical systems

Engineers realized long ago that many dynamical systems may be both studied and built using three operations: series (or composition); parallel (or tensor product); and feedback. Consider the functor category $\mathbf{Set}^{\mathbf{N}}$, where \mathbf{N} denotes the additive monoid of natural numbers. To give an object of this category is to give a set, U , and an endomorphism of that set, $\alpha : U \rightarrow U$. Such an object is a model of dynamical systems with a state-space U which have the property that if the system has the state $u \in U$ at a particular

point in time, the system will have the state $\alpha(u) \in U$ at a specified unit of time later. The category $\mathbf{Set}^{\mathbf{N}}$ is isomorphic to the category $\mathbf{Circ}(\mathbf{Set})(I, I)$, where I is the terminal object of \mathbf{Set} .

An expression in $\mathbf{Circ}(\mathbf{Set})$ (the evaluation of which is a circuit) from I to I will give us a dynamical system of the form $\alpha : U_1 \dots U_n \rightarrow U_1 \dots U_n$; that is, the set of states of the resulting system will be expressed as a product, though the action may not be. In fact, any dynamical system of the form $\alpha : UV \rightarrow UV$ can be realized as the evaluation of the expression $\text{fb}_{I,I}^U((V, c_{U,V} \cdot \alpha)_U)$. More generally, expressions of circuits will indicate the ‘dynamic dependence’ of each component of (the state-space of) the system upon the other components. For example, the composite of $(U, \alpha) : I \rightarrow X$ and $(V, \beta) : X \rightarrow I$ gives rise to the dynamical system

$$\begin{aligned} (U\beta) \cdot (\alpha V) & : UV \rightarrow UV \\ & : (u, v) \mapsto (p_U \cdot \alpha(u), \beta(p_X \cdot \alpha(u), v)). \end{aligned}$$

The U -component of a future state of this system is determined just by the U -component of the present state, while the V -component will depend both upon the variables u and v . From the diagram associated to a general expression of circuits we can see at a glance the components upon which any given component may depend. Given a system $\alpha : U_1 \dots U_n \rightarrow U_1 \dots U_n$ suppose we were interested in the possible behaviours of just one of the components, U_i . In general, all the elements of $U_1 \dots U_n$ must be considered as possible initial states for a behaviour; but by knowing on which components U_i depended, the number of starting states that need to be taken into account in order to determine the behaviours of U_i is greatly reduced. These considerations are clearly relevant to the study of dependence (and independence) structures in distributed systems ([9],[14],[18]).

Note that if X , U and Y are finite sets, the circuit $(U, \alpha) : X \rightarrow Y$ is precisely a Mealy automaton ([16]). The bicategory $\mathbf{Circ}(\mathbf{C})$, therefore, also provides a calculus for studying Mealy automata.

4 Properties of feedback

The main result of this section will be a normal form theorem for expressions in bicategories of circuits. Before getting to this, a number of properties

satisfied by the feedback operation will be examined, including the axioms for (a bicategorical version of) a trace. The isomorphisms referred to in the theorem and propositions of this section are natural (the variables being, of course, the circuits used in the results). The verification of this is straightforward and left to the reader. Also, we will write as if composition in our bicategories were strict. (Note that the identity and associative isomorphisms for horizontal composition in the bicategory $\Omega\Sigma(\mathbf{C}, \otimes)$ are constructed from the identity and associative isomorphisms for \otimes .)

4.1 Traced monoidal properties

The following proposition claims that the operation $\text{fb}_{X,Z}^Y$ is natural in the variable Y . This is referred to in [12] as the sliding axiom for a trace.

Proposition 4 *If $(U, \alpha) : X \otimes Y \rightarrow Z \otimes W$ and $(V, \beta) : W \rightarrow Y$ are circuits, Y can be fed back in $(Z \otimes (V, \beta)) \cdot (U, \alpha) : X \otimes Y \rightarrow Z \otimes Y$ if and only if W can be fed back in $(U, \alpha) \cdot (X \otimes (V, \beta)) : X \otimes W \rightarrow Z \otimes W$. Moreover, $c_{U,V}$ defines the 2-cell isomorphism*

$$\text{fb}_{X,Z}^Y((Z \otimes (V, \beta)) \cdot (U, \alpha)) \cong \text{fb}_{X,Z}^W((U, \alpha) \cdot (X \otimes (V, \beta))). \quad (4)$$

In terms of circuit diagrams, we have:

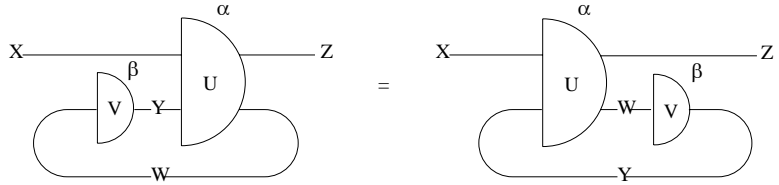

Proof. First we note that

$$(Z \otimes (V, \beta)) \cdot (U, \alpha) = (UV, (Uc_{Z,V}Y) \cdot (UZ\beta) \cdot (\alpha V))$$

and

$$(U, \alpha) \cdot (X \otimes (V, \beta)) = (VU, (V\alpha) \cdot (c_{X,V}YU) \cdot (X\beta U)).$$

Suppose Y can be fed back in $(Z \otimes (V, \beta)) \cdot (U, \alpha)$, and let $\theta : XUV \rightarrow Y$ be the structure map. That is, $(Xc_{UV,Y}) \cdot (1_{XUV}, \theta) : XUV \rightarrow XYUV$ is the equalizer of the pair

$$p'_Y, p_Y \cdot (Uc_{Z,V}Y) \cdot (UZ\beta) \cdot (\alpha V) : XYUV \rightarrow Y.$$

So if (x, u, v) is an arbitrary map into XUV , we have

$$\theta(x, u, v) = p_Y \cdot \beta(p_W \cdot \alpha(x, \theta(x, u, v), u), v). \quad (5)$$

We claim that $\gamma = p_W \cdot \alpha(c_{Y,X}U) \cdot (\theta, p_{XU}) \cdot (Xc_{V,U}) : XVU \rightarrow W$ is the structure map for feeding back W in $(U, \alpha) \cdot (X \otimes (V, \beta))$.

Now,

$$\begin{aligned} & p_W \cdot (V\alpha) \cdot (c_{X,V}YU) \cdot (X\beta U) \cdot (x, \gamma(x, v, u), v, u) \\ &= p_W \cdot \alpha(x, p_Y \cdot \beta(\gamma(x, v, u), v), u) \\ &= p_W \cdot \alpha(x, p_Y \cdot \beta(p_W \cdot \alpha(x, \theta(x, u, v), u), v), u) \\ &= p_W \cdot \alpha(x, \theta(x, u, v), u) \quad (\text{by equation 5}) \\ &= \gamma(x, v, u). \end{aligned}$$

So $(Xc_{V,U,W}) \cdot (1_{XVU}, \gamma)$ equalizes p'_W and $p_W \cdot (V\alpha) \cdot (c_{X,V}YU) \cdot (X\beta U)$.

Second, to see that $(Xc_{V,U,W}) \cdot (1_{XVU}, \gamma)$ is in fact an equalizer, suppose that we have a map (x, w, v, u) into $XWVU$ such that

$$w = p_W \cdot \alpha(x, p_Y \cdot \beta(w, v), u).$$

Then

$$p_Y \cdot \beta(w, v) = p_Y \cdot \beta(p_W \cdot \alpha(x, p_Y \cdot \beta(w, v), u), v).$$

Since $(Xc_{U,V,Y}) \cdot (1_{XUV}, \theta)$ is an equalizer, $p_Y \cdot \beta(w, v) = \theta(x, u, v)$. Therefore,

$$\begin{aligned} w &= p_W \cdot \alpha(x, \theta(x, u, v), u) \\ &= \gamma(x, v, u). \end{aligned}$$

This proves that γ is the structure map for feeding back W in $(U, \alpha) \cdot (X \otimes (V, \beta))$. A similar argument will show that if γ is the structure map for feeding back W in $(U, \alpha) \cdot (X \otimes (V, \beta))$, $p_Y \cdot \beta \cdot c_{V,W} \cdot (p_V, \gamma) \cdot (Xc_{U,V})$ will be the structure map for feeding back Y in $(Z \otimes (V, \beta)) \cdot (U, \alpha)$.

We now turn to the main result of the proposition. Suppose that θ is the structure map for feeding back Y in $(Z \otimes (V, \beta)) \cdot (U, \alpha)$, and therefore $\gamma = p_W \cdot \alpha(c_{Y,X}U) \cdot (\theta, p_{XU}) \cdot (Xc_{V,U})$ will be the structure map for feeding back W in $(U, \alpha) \cdot (X \otimes (V, \beta))$. By the definition of feedback, we have

$$\begin{aligned} \text{fb}_{X,Z}^Y((Z \otimes (V, \beta)) \cdot (U, \alpha)) &= \text{fb}_{X,Z}^Y(UV, (Uc_{Z,V}Y) \cdot (UZ\beta) \cdot (\alpha V)) \\ &= (UV, \epsilon), \end{aligned}$$

where $\epsilon = p_{UVZ} \cdot (Uc_{Z,V}Y) \cdot (UZ\beta) \cdot (\alpha V) \cdot (Xc_{UV,Y}) \cdot (1_{XUV}, \theta)$.

Also,

$$\begin{aligned} \text{fb}_{X,Z}^W((U, \alpha) \cdot (X \otimes (V, \beta))) &= \text{fb}_{X,Z}^W(VU, (V\alpha) \cdot (c_{X,V}YU) \cdot (X\beta U)) \\ &= (VU, \eta), \end{aligned}$$

where $\eta = p_{VUZ} \cdot (V\alpha) \cdot (c_{X,V}YU) \cdot (X\beta U) \cdot (Xc_{VU,W}) \cdot (1_{XVU}, \gamma)$.

We now have

$$\begin{aligned} p_{UZ} \cdot \epsilon(x, u, v) &= p_{UZ} \cdot \alpha(x, \theta(x, u, v), u) \\ &= p_{UZ} \cdot \alpha(x, p_Y \cdot \beta(\gamma(x, v, u), v), u) \quad (\text{by equation 5}) \\ &= p_{UZ} \cdot \eta(x, v, u), \end{aligned}$$

and

$$\begin{aligned} p_V \cdot \epsilon(x, u, v) &= p_V \cdot \beta(p_W \cdot \alpha(x, \theta(x, u, v), u), v) \\ &= p_V \cdot \beta(\gamma(x, v, u), v) \\ &= p_V \cdot \eta(x, v, u). \end{aligned}$$

So clearly, $c_{U,V} : UV \rightarrow VU$ defines a 2-cell

$$\text{fb}_{X,Z}^Y((Z \otimes (V, \beta)) \cdot (U, \alpha)) \cong \text{fb}_{X,Z}^W((U, \alpha) \cdot (X \otimes (V, \beta))).$$

□

The naturality of X and Z (or the tightening principle) is the claim of

Proposition 5 *If Y can be fed back in the circuit $(U, \alpha) : X \otimes Y \rightarrow Z \otimes Y$, Y can also be fed back in $((W, \gamma) \otimes Y) \cdot (U, \alpha) \cdot ((V, \beta) \otimes Y) : X' \otimes Y \rightarrow Z' \otimes Y$, for all circuits $(W, \gamma) : Z \rightarrow Z'$ and $(V, \beta) : X' \rightarrow X$. Moreover, the unit and associative isomorphisms for \otimes yield a 2-cell isomorphism*

$$(W, \gamma) \cdot \text{fb}_{X,Z}^Y(U, \alpha) \cdot (V, \beta) \cong \text{fb}_{X',Z'}^Y(((W, \gamma) \otimes Y) \cdot (U, \alpha) \cdot ((V, \beta) \otimes Y)). \quad (6)$$

In terms of circuit diagrams, we have:

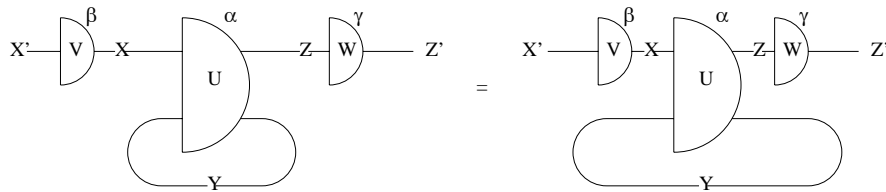

Proof. Consider circuits $(U, \alpha) : X \otimes Y \rightarrow Z \otimes Y$, $(V, \beta) : X' \rightarrow X$ and $(W, \gamma) : Z \rightarrow Z'$. Let

$$((W, \gamma) \otimes Y) \cdot (U, \alpha) \cdot ((V, \beta) \otimes Y) = (VUW, \epsilon),$$

where

$$\epsilon = (VU\gamma Y) \cdot (VUZc_{Y,W}) \cdot (V\alpha W) \cdot (\beta YUW) \cdot (X'c_{Y,V}UW).$$

Suppose that we can feedback Y in (U, α) , and let $\theta : XU \rightarrow Y$ be the structure map. Then we know for all maps (x, u) into XU

$$p_Y \cdot \alpha(x, \theta(x, u), u) = \theta(x, u). \quad (7)$$

We claim that $\psi = \theta \cdot p_{XU} \cdot \beta UW : X'VUW \rightarrow Y$ is the structure map for feeding back Y in (VUW, ϵ) . First note that for all (x', v, u, w)

$$\begin{aligned} & p_Y \cdot \epsilon \cdot (X'c_{VUW,Y}) \cdot (X'VUW, \psi)(x', v, u, w) \\ &= p_Y \cdot \epsilon(x', \theta(p_X \cdot \beta(x', v), u), u) \\ &= p_Y \cdot \alpha(p_X \cdot \beta(x', v), \theta(p_X \cdot \beta(x', v), u), u) \\ &= \theta(p_X \cdot \beta(x', v), u) \quad (\text{by equation 7}) \\ &= \psi(x', v, u, w). \end{aligned}$$

Second, if (x', y, v, u, w) is a map such that $p_Y \cdot \epsilon(x', y, v, u, w) = y$, then we have that $y = p_Y \cdot \alpha(p_X \cdot \beta(x', v), y, u)$. Since θ is the structure map for feeding back Y in (U, α) , we have that

$$\begin{aligned} y &= \theta(p_X \cdot \beta(x', v), u) \\ &= \psi(x', v, u, w). \end{aligned}$$

So $(X'c_{VUW,Y} \cdot (1_{X'VUW}, \psi) : X'VUW \rightarrow X'YVUW$ is the equalizer of the pair $p'_Y, p_Y \cdot \epsilon : X'YVUW \rightarrow Y$, meaning that ψ is the aforesaid structure map. A straightforward calculation will now verify the existence of the isomorphism 6. \square

Note that the converse of the first statement of the above proposition is not true. The following is a counter-example. Let

$$X = Y = \{1, 2\}, \quad I = \{*\}$$

and

$$\begin{aligned} \alpha &: XY \rightarrow Y \\ &: (1, 1) \mapsto 1 \\ &: (1, 2) \mapsto 2 \\ &: (2, 1) \mapsto 1 \\ &: (2, 2) \mapsto 1. \end{aligned}$$

Consider the circuit in **Set**, $(I, \alpha) : X \otimes Y \rightarrow I \otimes Y$. If E is the equalizer of $p'_Y, p_Y \cdot \alpha : XY \rightarrow Y$, clearly $|E| = 3$. So (I, α) cannot have a structure map for feeding back Y .

Now, if we consider the circuit $(I, \bar{2}) : I \rightarrow X$, where $\bar{2} : I \rightarrow X : * \mapsto 2$, then

$$(I, \alpha) \cdot ((I, \bar{2}) \otimes Y) = (I, \alpha \cdot (\bar{2}Y)) : I \otimes Y \rightarrow I \otimes Y.$$

Since

$$\begin{aligned} \alpha \cdot (\bar{2}Y) &: Y \rightarrow Y \\ &: 1 \mapsto 1 \\ &: 2 \mapsto 1 \end{aligned}$$

has a unique fixed point, Y can be fed back in $(I, \alpha \cdot (\bar{2}Y))$.

The following two propositions show that feedback satisfies, what is referred to in [12] as, the vanishing axioms.

Proposition 6 *For any circuit $(U, \alpha) : X \rightarrow Y$, the unit isomorphism for \otimes defines the 2-cell isomorphism*

$$\text{fb}_{X,Y}^I((U, \alpha) \otimes (I, 1_I)) \cong (U, \alpha). \tag{8}$$

In terms of circuit diagrams, we have:

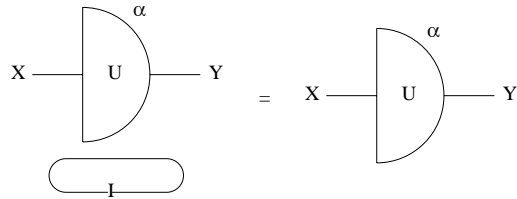

Proposition 7 *Let $(U, \alpha) : X \otimes Y \otimes Z \rightarrow A \otimes Y \otimes Z$ be a circuit. If we can feedback both Z in (U, α) and Y in $\text{fb}_{X \otimes Y, A \otimes Y}^Z(U, \alpha)$, we can feedback $Y \otimes Z$ in (U, α) . In this case,*

$$\text{fb}_{X, A}^Y(\text{fb}_{X \otimes Y, A \otimes Y}^Z(U, \alpha)) = \text{fb}_{X, A}^{Y \otimes Z}(U, \alpha). \quad (9)$$

In terms of circuit diagrams, we have:

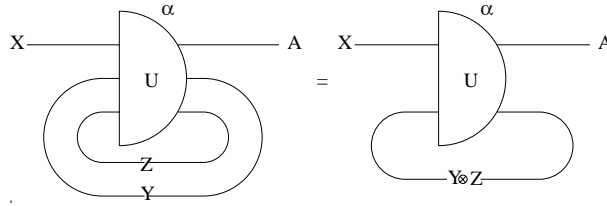

Proof. Let $\theta : XYU \rightarrow Z$ be the structure map for feeding back Z into $(U, \alpha) : X \otimes Y \otimes Z \rightarrow A \otimes Y \otimes Z$. Then we have for all (x, y, u)

$$p_Z \cdot \alpha(x, y, \theta(x, y, u), u) = \theta(x, y, u). \quad (10)$$

So

$$\text{fb}_{X \otimes Y, A \otimes Z}^Z(U, \alpha) = (U, p_{UAY} \cdot \alpha \cdot (XYc_{U,Z}) \cdot (1_{XYU}, \theta)).$$

Let $\psi : XU \rightarrow Y$ be the structure map for feeding back Y into $\text{fb}_{X \otimes Y, A \otimes Y}^Z(U, \alpha)$. Then for all (x, u)

$$p_Y \cdot \alpha(x, \psi(x, u), \theta(x, \psi(x, u), u), u) = \psi(x, u). \quad (11)$$

The claim is that $\gamma = (p_Y, \theta) \cdot (Xc_{U,Y}) \cdot (1_{XU}, \psi) : XU \rightarrow YZ$ is the structure map for feeding back $Y \otimes Z$ into (U, α) . To see that $(Xc_{U,YZ}) \cdot (1_{XU}, \gamma)$ is the equalizer of the pair $p'_{YZ}, p_{YZ} \cdot \alpha : XYZU \rightarrow YZ$, first note that

$$\begin{aligned} & p_{YZ} \cdot \alpha(x, \psi(x, u), \theta(x, \psi(x, u), u), u) \\ &= (\psi(x, u), \theta(x, \psi(x, u), u)) \quad (\text{by 10 and 11}) \\ &= \gamma(x, u). \end{aligned}$$

Furthermore, suppose there exists a map (x, y, z, u) such that

$$p_{YZ} \cdot \alpha(x, y, z, u) = (y, z).$$

Then $z = \theta(x, y, u)$, since θ was the structure map for feeding back Z . Therefore, $p_Y \cdot \alpha(x, y, \theta(x, y, u), u) = y$ and, since ψ is the structure map for feeding back Y , $y = \psi(x, u)$. Thus,

$$(x, y, z, u) = (x, p_Y \cdot \gamma(x, u), p_Z \cdot \gamma(x, u), u).$$

So, γ is the sought for structure map. Equation 9 follows from a straightforward calculation. \square

It easy to find a counter-example to the converse of the above proposition. Let

$$Y = Z = \{1, 2\}, \quad I = \{*\}$$

and

$$\begin{aligned} \alpha &: YZ \rightarrow YZ \\ &: (1, 1) \mapsto (1, 1) \\ &: (1, 2) \mapsto (2, 1) \\ &: (2, 1) \mapsto (1, 2) \\ &: (2, 2) \mapsto (1, 1), \end{aligned}$$

and consider the circuit $(I, \alpha) : I \otimes Y \otimes Z \rightarrow I \otimes Y \otimes Z$.

Since α has a unique fixed point, $Y \otimes Z$ can be fed back into (I, α) . Notice, however, if E is the equalizer of $p'_Z, p_Z \cdot \alpha : YZ \rightarrow Z$, $|E| = 1$, while $|Y| = 2$. So, Z cannot be fed back into (I, α) .

Proposition 8 *Suppose Y can be fed back in $(U, \alpha) : X \otimes Y \rightarrow Z \otimes Y$. Then for any $(V, \beta) : A \rightarrow B$, Y can be fed back in*

$$(Z \otimes (I, c_{Y,B})) \cdot ((U, \alpha) \otimes (V, \beta)) \cdot (X \otimes (I, c_{A,Y})) : XAY \rightarrow ZBY.$$

Furthermore, the unit and associative isomorphisms for \otimes define the 2-cell isomorphism

$$(\text{fb}_{X,Z}^Y(U, \alpha)) \otimes (V, \beta) \cong \text{fb}_{XA,ZB}^Y(Z \otimes (I, c_{Y,B})) \cdot ((U, \alpha) \otimes (V, \beta)) \cdot (X \otimes (I, c_{A,Y})). \quad (12)$$

In terms of circuit diagrams, we have:

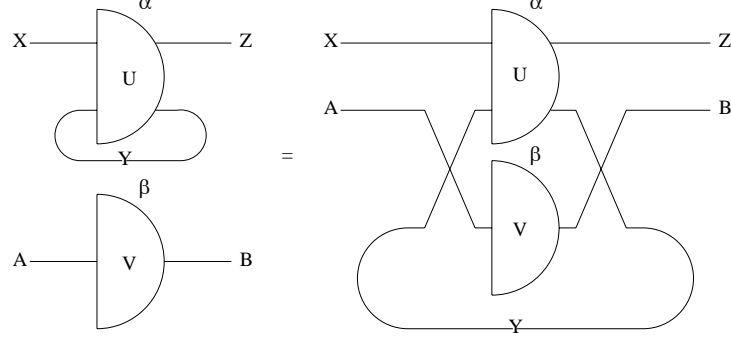

Proof. To begin with, observe that

$$(Z \otimes (I, c_{Y,B})) \cdot ((U, \alpha) \otimes (V, \beta)) \cdot (X \otimes (I, c_{A,Y})) = (UV, \epsilon),$$

where

$$\epsilon = (Uc_{Z,V}BY) \cdot (UZc_{Y,V}B) \cdot (\alpha \times \beta) \cdot (Xc_{A,Y}UV).$$

Suppose that $\theta : XU \rightarrow Y$ is the structure map for feeding back Y in (U, α) . We will show that $\gamma = \theta \cdot p_{XU} : XAUV \rightarrow Y$ is the structure map for feeding back Y in (UV, ϵ) .

We know that $(Xc_{U,Y}) \cdot (1_{XU}, \theta) : XU \rightarrow XYU$ is an equalizer of $p'_Y, p_Y \cdot \alpha$. Therefore $((Xc_{U,Y}) \cdot (1_{XU}, \theta))AV : XUAV \rightarrow XYUAV$ is an equalizer of

$$(p'_Y)AV, (p_Y \cdot \alpha)AV : XYUAV \rightarrow YAV.$$

In fact, $((Xc_{U,Y}) \cdot (1_{XU}, \theta))AV$ will also be an equalizer of the pair

$$p'_Y, p_Y \cdot (\alpha AV) : XYUAV \rightarrow Y.$$

So, $(XAc_{UV,Y}) \cdot (1_{XAUV}, \gamma) : XAUV \rightarrow XAYUV$ is an equalizer of

$$p'_Y, p_Y \cdot (\alpha AV) \cdot (Xc_{A,Y}UV) : XAYUV \rightarrow Y.$$

Clearly, then, $(XAc_{UV,Y}) \cdot (1_{XAUV}, \gamma)$ is also an equalizer of

$$p'_Y, p_Y \cdot \epsilon : XAYUV \rightarrow Y.$$

That is, γ is the aforesaid structure map. A straightforward calculation yields isomorphism 12. \square

This last result shows that feedback satisfies the superposition principle for a trace. The final axiom for a trace is yanking. For feedback, this amounts to

Proposition 9 For all X there exists a 2-cell isomorphism

$$\text{fb}_{X,X}^X((I, c_{X,X}) \cdot ((I, 1_X) \otimes (I, 1_X))) \cong (I, 1_X). \quad (13)$$

In terms of circuit diagrams, we have:

$$\text{Diagram 1} = \text{Diagram 2}$$

The following proposition is needed for proving Theorem 1.

Proposition 10 For any two circuits $(U, \alpha) : X \rightarrow Y$ and $(V, \beta) : Y \rightarrow Z$, Y can be fed back into $(I, c_{Y,Z}) \cdot ((U, \alpha) \otimes (V, \beta))$ and, moreover,

$$(V, \beta) \cdot (U, \alpha) \cong \text{fb}((I, c_{Y,Z}) \cdot ((U, \alpha) \otimes (V, \beta))). \quad (14)$$

In terms of circuit diagrams, we have:

$$\text{Diagram 1} = \text{Diagram 2}$$

Proof. Note that, by the functoriality of \otimes ,

$$\begin{aligned} (U, \alpha) \otimes (V, \beta) &\cong ((I, 1_Y) \cdot (U, \alpha)) \otimes ((V, \beta) \cdot (I, 1_Y)) \\ &\cong ((I, 1_Y) \otimes (V, \beta)) \cdot ((U, \alpha) \otimes (I, 1_Y)) \\ &\cong ((I, 1_Y) \otimes (V, \beta)) \cdot (I, 1_{Y^2}) \cdot ((U, \alpha) \otimes (I, 1_Y)). \end{aligned}$$

Therefore,

$$\begin{aligned} &\text{fb}_{X,Z}^Y((I, c_{Y,Z}) \cdot ((U, \alpha) \otimes (V, \beta))) \\ &\cong \text{fb}_{X,Z}^Y((I, c_{Y,Z}) \cdot ((I, 1_Y) \otimes (V, \beta)) \cdot (I, 1_{Y^2}) \cdot ((U, \alpha) \otimes (I, 1_Y))) \\ &\cong \text{fb}_{X,Z}^Y(((V, \beta) \otimes (I, 1_Y)) \cdot (I, c_{Y,Y}) \cdot (I, 1_{Y^2}) \cdot ((U, \alpha) \otimes (I, 1_Y))) \\ &\cong (V, \beta) \cdot \text{fb}_{Y,Y}^Y((I, c_{Y,Y}) \cdot (I, 1_{Y^2})) \cdot (U, \alpha) \quad (\text{using 6}) \\ &\cong (V, \beta) \cdot (U, \alpha) \quad (\text{using 13}). \end{aligned}$$

□

4.2 Normal form theorem

We are now in a position to prove a normal form theorem for expressions in bicategories of circuits. (In fact, the only ingredients used in the proof are the properties of a traced symmetric monoidal category.) For the rest of this section, lower case greek letters will be used to denote circuits. By a circuit we will mean an expression of the form $\epsilon : X_1 \otimes \dots \otimes X_n \rightarrow Y_1 \otimes \dots \otimes Y_m$. It is clear what is meant by the tensor product or feedback of such circuits. Let $s_{X,Y} = (I, c_{X,Y}) : X \otimes Y \rightarrow Y \otimes X$ be the symmetry for the tensor in a bicategory of circuits. When there is no cause for ambiguity or when precise specification is not relevant, the symmetry will be written as $s = s_{X,Y}$. Similarly, $\text{fb}_{X,Z}^Y$ will often be written as fb .

Theorem 1 *Any expression constructed from the circuits $\alpha_1, \dots, \alpha_n$ via the operations composition, tensor product and feedback is naturally isomorphic to an expression of the form $\text{fb}(\pi \cdot (\alpha_1 \otimes \dots \otimes \alpha_n) \cdot \pi')$, where π and π' are permutation wires.*

Proof. Let Υ be an expression constructed from the circuits $\alpha_1, \dots, \alpha_n$ via the operations composition, tensor product and feedback. By Proposition 10, we can replace every occurrence of a composite in Υ , say $\epsilon \cdot \eta$, by an expression of the form $\text{fb}(s \cdot (\eta \otimes \epsilon))$. So we can assume the only composites occurring in Υ are ones of the form $s \cdot \gamma$.

For any expression Υ , let $\sharp\text{fb}(\Upsilon)$ be the number of occurrences of the feedback operation in Υ . Before proceeding by induction on $\sharp\text{fb}(\Upsilon)$, we note some simple relations between composition with permutations and the tensor product and feedback operations.

If ϵ and η are circuits and π is a permutation wire whose codomain equals the domain of ϵ , there are permutations ρ and ρ' such that

$$\begin{aligned} \eta \otimes (\pi \cdot \epsilon) &\cong \rho \cdot (\eta \otimes \epsilon) \quad \text{and} \\ (\pi \cdot \epsilon) \otimes \eta &= \rho' \cdot (\epsilon \otimes \eta). \end{aligned}$$

Also, given a circuit ϵ and permutations π and π' of the input and output of $\text{fb}(\epsilon)$, there exist permutations ρ and ρ' such that

$$\pi \cdot \text{fb}(\epsilon) \cdot \pi' \cong \text{fb}(\rho \cdot \epsilon \cdot \rho').$$

For the case $\sharp\text{fb}(\Upsilon) = 0$, clearly $\Upsilon \cong \pi \cdot (\alpha_1 \otimes \dots \otimes \alpha_n)$, for some permutation π . So, by the isomorphism 8, the claim of the theorem holds.

Assume that the theorem is satisfied if $\sharp\text{fb}(\Upsilon) = n$, where $n \geq 0$. Suppose $\sharp\text{fb}(\Upsilon) = n + 1$. Then there exist expressions Φ and Ψ and a permutation π_1 such that Υ is naturally isomorphic to $\pi_1 \cdot (\text{fb}(\Phi) \otimes \Psi)$. We know by Proposition 8 that there are permutations π_2 and π'_2 such that

$$\text{fb}(\Phi) \otimes \Psi \cong \text{fb}(\pi_2 \cdot (\Phi \otimes \Psi) \cdot \pi'_2).$$

Therefore,

$$\begin{aligned} \Upsilon &\cong \pi_1 \cdot \text{fb}(\pi_2 \cdot (\Phi \otimes \Psi) \cdot \pi'_2) \\ &\cong \text{fb}(\pi_3 \cdot (\Phi \otimes \Psi) \cdot \pi'_2), \end{aligned}$$

where π_3 is a permutation.

Note that $\sharp\text{fb}(\Phi \otimes \Psi) = n$ and $\Phi \otimes \Psi$ must be constructed from the circuits $\alpha_1, \dots, \alpha_n$ and permutation wires. So by the induction hypothesis,

$$\Phi \otimes \Psi \cong \text{fb}(\pi_4 \cdot (\alpha_1 \otimes \dots \otimes \alpha_n) \cdot \pi'_4),$$

where π_4 and π'_4 are permutations. Therefore, there are permutations π and π' such that

$$\begin{aligned} \Upsilon &\cong \text{fb}(\pi_3 \cdot \text{fb}(\pi_4 \cdot (\alpha_1 \otimes \dots \otimes \alpha_n) \cdot \pi'_4) \cdot \pi'_2) \\ &\cong \text{fb}(\text{fb}(\pi \cdot (\alpha_1 \otimes \dots \otimes \alpha_n) \cdot \pi')) \\ &= \text{fb}(\pi \cdot (\alpha_1 \otimes \dots \otimes \alpha_n) \cdot \pi') \quad (\text{by Proposition 7}). \end{aligned}$$

□

The proof of the above theorem provides an algorithm for converting any expression of the circuits $\alpha_1, \dots, \alpha_n$ into an expression of the form $\text{fb}(\pi \cdot (\alpha_1 \otimes \dots \otimes \alpha_n) \cdot \pi')$. In fact, it is clear this algorithm can be generalized in order to handle the situation when our expressions are built out of a finite number of specified components.

5 Behaviours and equilibrium states of circuits

Only circuits in \mathbf{Set} will be considered in this section. The constructions presented here may also be defined for circuits in a topos with a natural numbers object.

5.1 The homomorphisms behaviour and equilibrium

Let us recall the notions of equilibrium and behaviour which we intend to generalize. Consider the global sections functor

$$\begin{aligned} \mathbf{Set}^{\mathbf{N}}(1, -) &: \mathbf{Set}^{\mathbf{N}} \rightarrow \mathbf{Set} \\ &: (X, \alpha : X \rightarrow X) \mapsto \{x \in X \mid \alpha(x) = x\}, \end{aligned}$$

where 1 is, of course, the terminal object of $\mathbf{Set}^{\mathbf{N}}$. A natural transformation $f : 1 \rightarrow (X, \alpha)$ is called an equilibrium state of the dynamical system (X, α) . So the global sections functor sends a dynamical system to its set of equilibrium states.

For the rest of this paper N will denote the set of natural numbers. Let $T : \mathbf{N} \rightarrow \mathbf{Set}$ denote a representable functor in $\mathbf{Set}^{\mathbf{N}}$. Suppose (X, α) is any other dynamical system. Then to give a natural transformation $f : T \rightarrow (X, \alpha)$ is to give a sequence $(x_i)_{i \in \mathbf{N}}$ of elements of X such that $\alpha(x_i) = x_{i+1}$. We call f a behaviour of (X, α) . Thus the functor

$$\mathbf{Set}^{\mathbf{N}}(T, -) : \mathbf{Set}^{\mathbf{N}} \rightarrow \mathbf{Set}$$

will send a dynamical system to the set of behaviours of that system.

In this section the bicategories $\mathbf{Circ}(\mathbf{Set})$ and $\mathbf{Span}(\mathbf{Set})$ will be written as \mathbf{Circ} and \mathbf{Span} respectively. Spans from X to Y will be represented by ordered triples (p, W, q) , where $p : W \rightarrow X$ and $q : W \rightarrow Y$. We call p the first leg, q the second leg and W the centre of the span.

If $(U, \alpha) : X \rightarrow Y$ is a circuit, an element of U is called a *state* of (U, α) , and an element of X or Y is referred to as an *input* or an *output* for (U, α) respectively.

Definition 3 The following data defines the homomorphism

$$\text{equilibrium} : \mathbf{Circ} \rightarrow \mathbf{Span}.$$

- If X is an object of **Circ**, $\text{equilibrium}(X) = X$.
- If $(U, \alpha) : X \rightarrow Y$ is a circuit, let

$$W = \{(x, u) \in XU \mid p_U \cdot \alpha(x, u) = u\},$$

$$p : W \rightarrow X : (x, u) \mapsto x,$$

and

$$q : W \rightarrow Y : (x, u) \mapsto p_Y \cdot \alpha(x, u).$$

Then, $\text{equilibrium}(U, \alpha) = (p, W, q)$. If $(x, u) \in W$, u is called an *equilibrium state* of the circuit.

- If $\theta : (U, \alpha) \rightarrow (V, \beta)$ is a 2-cell between circuits, let W and W' be the centres of $\text{equilibrium}(U, \alpha)$ and $\text{equilibrium}(V, \beta)$ respectively. Then

$$\begin{aligned} \text{equilibrium}(\theta) & : W \rightarrow W' \\ & : (x, u) \mapsto (x, \theta(u)). \end{aligned}$$

defines a 2-cell in **Span**.

Implicit in the above definition is the claim that the above data defines a homomorphism of bicategories. We will only present the proof that composition of arrows is preserved up to a natural isomorphism.

Let $(U, \alpha) : X \rightarrow Y$ and $(V, \beta) : Y \rightarrow Z$ be circuits. Then the centre of $\text{equilibrium}(V, \beta) \cdot \text{equilibrium}(U, \alpha)$ is the set

$$S = \{(x, u, y, v) \in XU Y V \mid p_U \cdot \alpha(x, u) = u, p_Y \cdot \alpha(x, u) = y \\ \text{and } p_V \cdot \beta(y, v) = v\},$$

while the centre of $\text{equilibrium}((V, \beta) \cdot (U, \alpha))$ is the set

$$W = \{(x, u, v) \in XU V \mid (p_U \cdot \alpha(x, u), p_V \cdot \beta(p_Y \cdot \alpha(x, u), v)) = (u, v)\}.$$

The function

$$\begin{aligned} b_{(U, \alpha), (V, \beta)} & : S \rightarrow W \\ & : (x, u, y, v) \mapsto (x, u, v) \end{aligned}$$

is bijective, since the rule $(x, u, v) \mapsto (x, u, p_Y \cdot \alpha(x, u), v)$ defines a function that is the inverse of $b_{(U, \alpha), (V, \beta)}$. It is straightforward to check that this isomorphism is natural in the variables (U, α) and (V, β) . So equilibrium preserves composition.

Definition 4 The following data defines the homomorphism

$$\text{behaviour} : \mathbf{Circ} \rightarrow \mathbf{Span}.$$

- If X is an object of \mathbf{Circ} , $\text{behaviour}(X) = X^N$.
- If $(U, \alpha) : X \rightarrow Y$ is a circuit, let

$$W = \{(x_i, u_i, y_i)_{i \in N} \in (XUY)^N \mid \forall i \in N \alpha(x_i, u_i) = (u_{i+1}, y_i)\},$$

$$\begin{aligned} p & : W \rightarrow X^N \\ & : (x_i, u_i, y_i)_{i \in N} \mapsto (x_i)_{i \in N}, \end{aligned}$$

and

$$\begin{aligned} q & : W \rightarrow Y^N \\ & : (x_i, u_i, y_i)_{i \in N} \mapsto (y_i)_{i \in N}. \end{aligned}$$

Then, $\text{behaviour}(U, \alpha) = (p, W, q)$. An element $w \in W$ is called a *behaviour* of the circuit, while $p(w)$ and $q(w)$ are respectively called the corresponding input and output behaviours.

- If $\theta : (U, \alpha) \rightarrow (V, \beta)$ is a 2-cell between circuits, let W and W' be the centres of $\text{behaviour}(U, \alpha)$ and $\text{behaviour}(V, \beta)$ respectively. Then

$$\begin{aligned} \text{behaviour}(\theta) & : W \rightarrow W' \\ & : (x_i, u_i, y_i)_{i \in N} \mapsto (x_i, \theta(u_i), y_i)_{i \in N}. \end{aligned}$$

defines a 2-cell in \mathbf{Span} .

Implicit in this definition is the statement that the above data defines a homomorphism of bicategories. Again, we will only prove that composition of arrows is preserved up to isomorphism.

Let $(U, \alpha) : X \rightarrow Y$ and $(V, \beta) : Y \rightarrow Z$ be circuits. Then the centre of $\text{behaviour}(V, \beta) \cdot \text{behaviour}(U, \alpha)$ is the set

$$S = \{(x_i, u_i, y_i, y'_i, v_i, z_i)_{i \in N} \mid \forall i \in N \alpha(x_i, u_i) = (u_{i+1}, y_i), \quad y_i = y'_i \\ \text{and } \beta(y_i, v_i) = (v_{i+1}, z_i)\},$$

while the centre of $\text{behaviour}((V, \beta) \cdot (U, \alpha))$ is the set

$$W = \{(x_i, u_i, v_i)_{i \in N} \mid \forall i \in N (U\beta) \cdot (\alpha V)(x_i, u_i, v_i) = (u_{i+1}, v_{i+1}, z_i)\}.$$

The function

$$d_{(U,\alpha),(V,\beta)} : S \rightarrow W$$

$$: (x_i, u_i, y_i, y'_i, v_i, z_i)_{i \in N} \mapsto (x_i, u_i, v_i)_{i \in N}$$

is bijective, since the rule

$$(x_i, u_i, v_i)_{i \in N} \mapsto (x_i, u_i, p_Y \cdot \alpha(x_i, u_i), p_Y \cdot \alpha(x_i, u_i), v_i, p_Z \cdot \beta(p_Y \cdot \alpha(x_i, u_i), v_i))_{i \in N}$$

defines a function that is its inverse. The function $d_{(U,\alpha),(V,\beta)}$ defines an isomorphism of spans that is natural in the variables (U, α) and (V, β) . So behaviour preserves composition.

Notice that, on the category $\mathbf{Circ}(I, I)$, equilibrium and behaviour coincide with $\mathbf{Set}^{\mathbf{N}}(1, -)$ and $\mathbf{Set}^{\mathbf{N}}(T, -)$ respectively.

5.2 Remarks on the interpretation of circuits

A circuit $(U, \alpha) : X \rightarrow Y$ models a system whose motion is controlled by a set X of actions. That is, if the state of this system at a particular point in time is $u \in U$ and the system is then acted upon by $x \in X$, the system will change its state to $p_U \cdot \alpha(x, u)$. Accompanying this change of state is the output $p_Y \cdot \alpha(x, u)$. A behaviour of the system is determined by an initial state and a sequence of actions. The following diagram should elucidate these remarks.

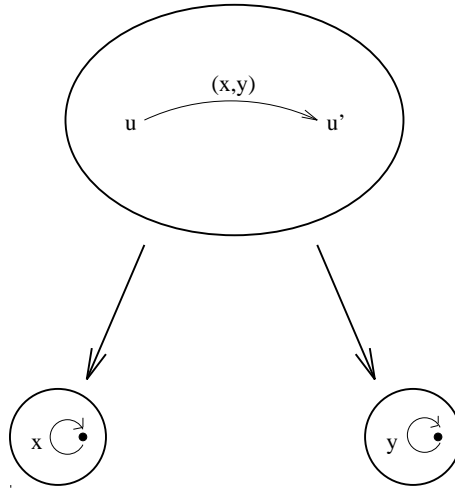

The above picture represents a span of categories. The centre of this span is the free category on the directed graph with vertex set U and whose edges from $u \in U$ to $u' \in U$ are pairs $(x, y) \in XY$ such that $\alpha(x, u) = (u', y)$. This category records both the states and the possible motions of the system. The domain and codomain of the span are respectively the free monoid on X and the free monoid on Y . The fact that the elements of X act on the system can now be expressed by stating that the left leg of this span is a discrete op-fibration.

Let us consider the behaviours of an infinitesimal, say $(I, \alpha) : X \rightarrow Y$. As

$$\text{behaviour}(I, \alpha) = (1_{X^N}, X^N, \alpha^N) : X^N \rightarrow Y^N,$$

any sequence $(x_i)_{i \in N} \in X^N$ will be a behaviour; that is, there are no internal dynamics governing the motion of the circuit as its state-space is I . These structures are called infinitesimals since an input x for (I, α) immediately manifests itself as the output $\alpha(x)$. Of particular interest are the wires. Consider the diagonal wire, $(I, \Delta_X) : X \rightarrow XX$:

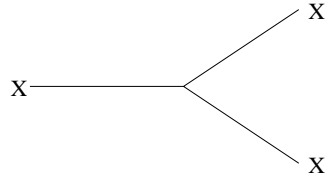

Though there is a bijection between the set of behaviours of (I, Δ_X) and $(I, 1_X)$, the circuits are different - the output of the first process is XX , while the output for the second is X . So wires are examples of circuits which can be viewed in two ways: on the one hand, as distributed bodies with a domain and codomain that can be composed with other circuits; on the other hand, as a device which behaves as a single unit or equipotential region.

As a behaviour $(x_i, u_i, y_i)_{i \in N}$ of $(U, \alpha) : X \rightarrow Y$ satisfies the condition $\alpha(x_i, u_i) = (u_{i+1}, y_i)$ (instead of the condition $\alpha(x_i, u_i) = (u_{i+1}, y_{i+1})$), the reader may well ask whether all circuits are, in some sense, infinitesimals. It is true that circuits in general may have an infinitesimal aspect, and this is essentially why feedback was not defined for all circuits. (Try feeding back an instantaneous *not* gate.)

However, as was shown in Section 3, delayed circuits can always be fed back. In fact, to give a behaviour of $(U, \alpha)_Y$ is equivalent to giving a sequence $(x_i, u_i, y_i)_{i \in \mathbb{N}}$ such that $\alpha(x_i, u_i) = (u_{i+1}, y_{i+1})$.

5.3 Preservation properties of equilibrium and behaviour

For the homomorphisms equilibrium and behaviour to be of any interest they must preserve the operations we can perform on circuits. The preservation of composition has already been shown; of course, before we can talk about the preservation of the tensor product and feedback, **Span** must be equipped with such operations. **Span** is, however, a compact closed bicategory (and hence traced symmetric monoidal).

Definition 5 A symmetric monoidal structure on **Span** is defined by the homomorphism $\otimes : \mathbf{Span} \times \mathbf{Span} \rightarrow \mathbf{Span}$, the data for which we now present.

- If X and Y are objects of **Span**, $X \otimes Y = XY$.

- If $(f, W, g) : X \rightarrow A$ and $(p, V, q) : Y \rightarrow B$ are spans,

$$(f, W, g) \otimes (p, V, q) = (f \times p, WV, g \times q).$$

- If $\theta : W \rightarrow W'$ and $\psi : V \rightarrow V'$ define the 2-cells $\theta : (f, W, g) \rightarrow (f', W', g')$ and $\psi : (p, V, q) \rightarrow (p', V', q')$, $\theta \otimes \psi = \theta \times \psi$ defines a 2-cell from $(f, W, g) \otimes (p, V, q)$ to $(f', W', g') \otimes (p', V', q')$.

Definition 6 For any triple $X, Y, Z \in \text{ob}(\mathbf{Span})$ the functor

$$\text{Fb}_{X,Z}^Y : \mathbf{Span}(X \otimes Y, Z \otimes Y) \rightarrow \mathbf{Span}(X, Z)$$

is defined as follows.

- If (f, W, g) is a span from $X \otimes Y$ to $Z \otimes Y$, let $e : E \rightarrow W$ be the equalizer in **Set** of the pair $p_Y \cdot f, p'_Y \cdot g : W \rightarrow Y$, where $p_Y : XY \rightarrow Y$ and $p'_Y : ZY \rightarrow Y$ are projections. Then, $\text{Fb}(f, W, g) = (p_X \cdot f \cdot e, E, p_Z \cdot g \cdot e)$ is a span from X to Z , where $p_X : XY \rightarrow X$ and $p_Z : ZY \rightarrow Z$ are projections.

- Let (f, W, g) and (f', W', g') be spans from $X \otimes Y$ to $Z \otimes Y$, and suppose $\theta : W \rightarrow W'$ defines a 2-cell from (f, W, g) to (f', W', g') . Let $\text{Fb}(f, W, g) = (p, E, q)$ and $\text{Fb}(f', W', g') = (p', E', q')$, and let $e : E \rightarrow W$ and $e' : E' \rightarrow W'$ be the equalizers as defined above. Then, by the universal property of equalizers, there exists a unique function $\text{Fb}(\theta) : E \rightarrow E'$ such that $\theta \cdot e = e' \cdot \text{Fb}(\theta)$. It is clear that $\text{Fb}(\theta)$ defines a 2-cell from (p, E, q) to (p', E', q') .

We note that the operation Fb satisfies all the defining properties of a trace (with equations being replaced by natural isomorphisms, of course).

The main result of this section is

Theorem 2 *The homomorphisms equilibrium and behaviour preserve the operations tensor product and feedback up to natural isomorphisms.*

Proof. We only show that equilibrium preserves tensor products and feedback since the proof that behaviour preserves these structures is very similar.

We adopt the following notation. The tensor products on **Circ** and **Span** will be denoted by \otimes_{Circ} and \otimes_{Span} respectively, though when considering the tensor product of objects we will use \otimes for both. The action of \otimes_{Circ} and \otimes_{Span} on hom-categories will be represented respectively by

$$\otimes_{\text{Circ}}^{X,A,Y,B} : \mathbf{Circ}(X, A) \times \mathbf{Circ}(Y, B) \rightarrow \mathbf{Circ}(X \otimes Y, A \otimes B),$$

and

$$\otimes_{\text{Span}}^{X,A,Y,B} : \mathbf{Span}(X, A) \times \mathbf{Span}(Y, B) \rightarrow \mathbf{Span}(X \otimes Y, A \otimes B).$$

Also,

$$\text{equ}_{X,Y} : \mathbf{Circ}(X, Y) \rightarrow \mathbf{Span}(\text{equilibrium}(X), \text{equilibrium}(Y))$$

will denote the action of equilibrium on hom-categories.

We now show that equilibrium preserves tensor products by constructing a natural isomorphism

$$b^{X,A,Y,B} : \otimes_{\text{Span}}^{X,A,Y,B} \cdot (\text{equ}_{X,A} \times \text{equ}_{Y,B}) \rightarrow \text{equ}_{X \otimes Y, A \otimes B} \cdot \otimes_{\text{Circ}}^{X,A,Y,B}.$$

Let $(U, \alpha) : X \rightarrow A$ and $(V, \beta) : Y \rightarrow B$ be circuits. Then the centre of the span

$$\text{equ}_{X,A}(U, \alpha) \otimes_{\text{Span}}^{X,A,Y,B} \text{equ}_{Y,B}(V, \beta)$$

is the set

$$S = \{(x, u, y, v) \in XUYV \mid p_U \cdot \alpha(x, u) = u \text{ and } p_V \cdot \beta(y, v) = v\},$$

while the centre of the span

$$\text{equ}_{X \otimes Y, A \otimes B}((U, \alpha) \otimes_{\text{Circ}}^{X,A,Y,B} (V, \beta))$$

is the set

$$T = \{(x, y, u, v) \in XYUV \mid p_{UV} \cdot (\alpha \times \beta)(x, u, y, v) = (u, v)\}.$$

Clearly

$$\begin{aligned} b_{(U,\alpha),(V,\beta)}^{X,A,Y,B} &: S \rightarrow T \\ &: (x, u, y, v) \mapsto (x, y, u, v) \end{aligned}$$

defines an isomorphism of spans. It is straightforward to check that it is natural in (U, α) and (V, β) .

Let us turn our attention to feedback. The full subcategory of circuits from $X \otimes Y$ to $Z \otimes Y$ for which we can feed back Y is denoted by $I : \mathbf{Set}_{X,Z}^Y \rightarrow \mathbf{Circ}(X \otimes Y, Z \otimes Y)$. We are required to construct a natural isomorphism

$$d^{X,Y,Z} : \text{Fb}_{X,Z}^Y \cdot \text{equ}_{X \otimes Y, Z \otimes Y} \cdot I \rightarrow \text{equ}_{X,Z} \cdot \text{fb}_{X,Z}^Y.$$

Suppose that $(U, \alpha) : X \otimes Y \rightarrow Z \otimes Y$ is a circuit with a structure map $\tau : XU \rightarrow Y$ for feeding back Y . The centre of the span $\text{Fb}_{X,Z}^Y(\text{equ}_{X \otimes Y, Z \otimes Y}(U, \alpha))$ is the set

$$S = \{(x, y, u) \in XYU \mid p_U \cdot \alpha(x, y, u) = u \text{ and } y = p_Y \cdot \alpha(x, y, u)\},$$

while the centre of the span $\text{equ}_{X,Z}(\text{fb}_{X,Z}^Y(U, \alpha))$ is the set

$$T = \{(x, u) \in XU \mid p_U \cdot \alpha(x, \theta(x, u), u) = u\}.$$

By the defining property of θ , $p_Y \cdot \alpha(x, y, u) = y$ if and only if $y = \theta(x, u)$. Thus,

$$\begin{aligned} d_{(U,\alpha)}^{X,Y,Z} &: S \rightarrow T \\ &: (x, y, u) \mapsto (x, u) \end{aligned}$$

defines an isomorphism of spans. It is easy to check that it is natural in (U, α) .

□

The scientific value of the previous theorem is that, as one would expect, to give a behaviour of a constructed circuit is equivalent to giving behaviours of the components of the circuit that agree on the wires. In Computer Science, this is called the *compositionality* of behaviour. So we can calculate the behaviours of complicated circuits by considering the behaviours of the components and then carrying out the construction in **Span**. In the following example the circuits (U, α) , (V, β) and (W, γ) will be denoted by α , β and γ . It is clear there is a bijection between the set of behaviours of the circuit

$$\text{fb}_{A,B}^B(\Delta_B \cdot \beta \cdot (\text{fb}_{I,C}^E(\gamma) \otimes 1_D) \cdot \alpha)$$

with corresponding circuit diagram

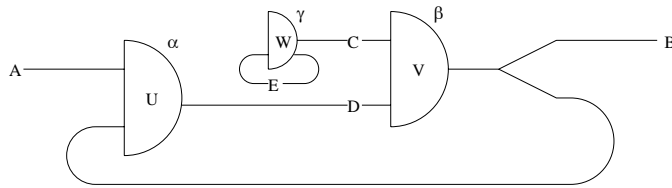

and that of the circuit

$$\text{fb}_{A,B}^{E \otimes C \otimes D}((s_{E \otimes C, B} \otimes 1_D) \cdot (\gamma \otimes 1_B \otimes \alpha) \cdot (1_E \otimes s_{A, B} \otimes 1_B) \cdot (1_{E \otimes A} \otimes \Delta_B) \cdot (s_{A, E} \otimes \beta))$$

with corresponding circuit diagram

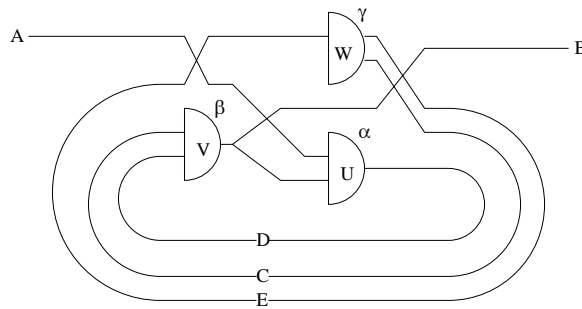

Of course, using the results of the last section it is easy to see that both these circuits are isomorphic to

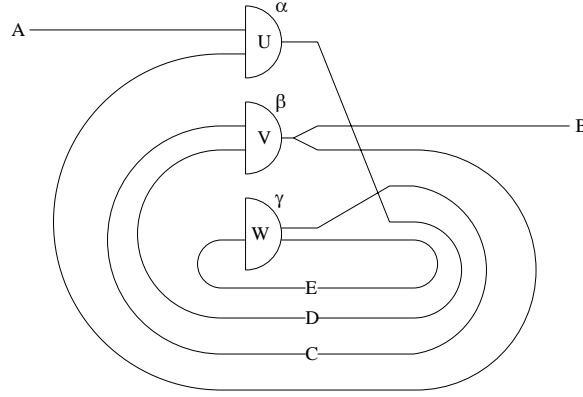

5.4 Relations as a model of circuits

In the remainder of this section a connection will be established between **Circ** and one of the best known examples of a category which admits a compact closed structure – namely, **Rel**, the category of sets and relations. Using the compact closed structure, there is a way to equip **Rel** with a trace (or feedback operation). Given a relation $R : X \otimes Y \rightarrow Z \otimes Y$, $\text{Tr}(R) : X \rightarrow Z$ is the relation defined by: $x(\text{Tr}(R))y$ if and only if there exists $y \in Y$ such that $(x, y)R(z, y)$. **Rel** can be viewed as a locally ordered category, and, as the next proposition indicates, is a reflection of the bicategory **Span**.

Proposition 11 *There is a homomorphism $\Lambda : \mathbf{Span} \rightarrow \mathbf{Rel}$ which preserves tensor products and feedback.*

Proof. The following is the data for Λ .

- If $X \in \text{ob}(\mathbf{Span})$, $\Lambda(X) = X$.
- If (f, W, g) is a span from X to Y , $x(\Lambda(f, W, g))y$ if and only if there exists $w \in W$ such that $f(w) = x$ and $g(w) = y$.

Recall that if $R, S : X \rightarrow Y$ are relations, we write $R \leq S$ if and only if for $x \in X$ and $y \in Y$, xRy implies that xSy . It is clear that if there exists a 2-cell from a span (f, W, g) to (p, U, q) , $\Lambda(f, W, g) \leq \Lambda(p, U, q)$. A moment's thought will verify that Λ is a tensor product and feedback preserving homomorphism.

□

The construction Λ abstracts from a span only that information which relates the domain to the codomain, ignoring the internal structure of the span. In fact, combining this proposition with Theorem 2 yields the result that the homomorphisms

$$\Lambda \cdot \text{equilibrium}, \Lambda \cdot \text{behaviour} : \mathbf{Circ} \rightarrow \mathbf{Rel}$$

preserve tensor products and feedback. So there are two ways in which a relation can be thought of as an abstraction of a circuit. On the one hand, a relation $R : X \rightarrow Y$ could be used to model the class of circuits of the form $(U, \alpha) : X \rightarrow Y$ that satisfy the condition: if xRy then there exists an equilibrium state $u \in U$ of the circuit such that $\alpha(x, u) = (u, y)$. On the other hand, a relation $R : X^N \rightarrow Y^N$ could model the circuits with input X and output Y that have the property: if $(x_i)_{i \in N} R (y_j)_{j \in N}$ then there exists a behaviour of the circuit with corresponding input and output behaviours $(x_i)_{i \in N}$ and $(y_j)_{j \in N}$.

The category \mathbf{Rel} has been used to model *real* circuits in both these ways in [11] and [4]. In this sense, the theory of circuits here developed is more *concrete* than theories using only locally ordered bicategories such as \mathbf{Rel} . We wish to point out that though \mathbf{Rel} models neither the internal state nor the dynamics of processes, it is still of interest since calculations there are relatively simple and often illuminating.

6 Elgot automata

An Elgot automaton is defined to be process in a category with sums, and we construct a feedback operation for bicategories of such processes. A connection between Elgot automata and iteration theories is made via a structure preserving homomorphism from $\Omega\Sigma(\mathbf{Set}, +)$ to \mathbf{Par} , the locally ordered category of sets and partial functions.

6.1 Feedback for Elgot automata

If (\mathbf{C}, \otimes) is a monoidal category, let \otimes^{op} be the induced tensor product on \mathbf{C}^{op} .

Proposition 12 *The canonical homomorphism*

$$\Phi_{(\mathbf{C}, \otimes)} : \Omega\Sigma(\mathbf{C}, \otimes) \rightarrow (\Omega\Sigma(\mathbf{C}^{op}, \otimes^{op}))^{coop}$$

is a tensor product preserving isomorphism of bicategories.

The local action of $\Phi_{(\mathbf{C}, \otimes)}$ will be denoted by

$$\Phi_{(\mathbf{C}, \otimes)}^{X,Y} : \Omega\Sigma(\mathbf{C}, \otimes)(X, Y) \rightarrow ((\Omega\Sigma(\mathbf{C}^{op}, \otimes^{op}))(Y, X))^{op}.$$

We adopt the following conventions when working in categories with finite sums. Given a family of arrows $(f_i : X_i \rightarrow S)_{i \in [n]}$, where $[n]$ is a natural number, let $(f_1 \mid \dots \mid f_n) : X_1 + \dots + X_n \rightarrow S$ be the unique arrow defined by the universal property of sums. If $\phi : [j] \rightarrow [n]$ is an injective function, write $i_{X_{\phi(1)} + \dots + X_{\phi(j)}} : X_{\phi(1)} + \dots + X_{\phi(j)} \rightarrow X_1 + \dots + X_n$ for the obvious composite of an injection and symmetries (except in those circumstances where this notation would be ambiguous).

Let \mathbf{C} be a category that admits binary coproducts. Let \oplus denote the canonical tensor product on $\Omega\Sigma(\mathbf{C}, +)$. A process in $(\mathbf{C}, +)$ is called an *Elgot automaton* in \mathbf{C} , and we write $\mathbf{Elgot}(\mathbf{C})$ for $\Omega\Sigma(\mathbf{C}, +)$. The concept of an Elgot automaton arose in the analysis of imperative programs ([8],[13]).

Suppose $(U, \alpha) : X \oplus Y \rightarrow Z \oplus Y$ is an Elgot automaton with the property that there exists $\tau : Y \rightarrow U + Z$ such that $(1_{U+Z} \mid \tau) : U + Z + Y \rightarrow U + Z$ is the coequalizer of the pair $i'_Y, \alpha \cdot i_Y : Y \rightarrow U + Z + Y$, where $i'_Y : Y \rightarrow U + Z + Y$ and $i_Y : Y \rightarrow X + Y + U$ are injections. In this case, we say we can feedback Y in (U, α) and τ is called the structure map for feeding back Y in the process. Define $(\mathbf{C}, +)_{X,Z}^Y$ to be the full subcategory of $\mathbf{Elgot}(\mathbf{C})(X \oplus Y, Z \oplus Y)$ consisting of those Elgot automata which have a structure map for feeding back Y .

Proposition 13 *The isomorphism $\Phi_{(\mathbf{C}, +)}^{X+Y, Z+Y}$ restricts to an isomorphism*

$$\Psi_{(\mathbf{C}, +)}^{X,Y,Z} : (\mathbf{C}, +)_{X,Z}^Y \rightarrow ((\mathbf{C}^{op}, \times)_{Z,X}^Y)^{op},$$

where, of course, $\times = +^{op}$.

A feedback operation for Elgot automata is now defined via the feedback operation for circuits.

Definition 7 The functor $\text{fb}(\mathbf{C}, +)_{X,Z}^Y : (\mathbf{C}, +)_{X,Z}^Y \rightarrow \mathbf{Elgot}(\mathbf{C})(X, Z)$ is the composite

$$(\Psi_{(\mathbf{C},+)}^{X,Z})^{-1} \cdot (\text{fb}(\mathbf{C}^{op}, \times)_{Z,X}^Y)^{op} \cdot \Psi_{(\mathbf{C},+)}^{X+Y,Z+Y}.$$

So, if $(U, \alpha) : X \oplus Y \rightarrow Z \oplus Y$ is an Elgot automaton with a structure map $\tau : Y \rightarrow U + Z$ for feeding back Y ,

$$\text{fb}(\mathbf{C}, +)_{X,Z}^Y(U, \alpha) = (U, (1_{U+Z} \mid \tau) \cdot \alpha \cdot i_{X+U}) : X \rightarrow Z.$$

As the homomorphism $\Phi_{(\mathbf{C},+)}$ preserves tensor products, it is clear that traced monoidal properties and the normal form theorem that were proved in Section 4 as well as the results relating feedback and delayed circuits in Section 2 are true for $\text{fb}(\mathbf{C}, +)$. Diagrams can also be drawn for expressions built out of the operations composition, \oplus and $\text{fb}(\mathbf{C}, +)$. The only difference between *Elgot diagrams* – the diagrams for Elgot automata – and diagrams for circuits is that the diagonal and projection wires are replaced by the following codiagonal and injection wires:



6.2 Interpretation of Elgot automata

The reader is encouraged to think of an Elgot automaton in \mathbf{Set} as a dynamical system (that is, as an object of $\mathbf{Set}^{\mathbf{N}}$) equipped with a set of starting states and a set of equilibrium (or final) states. For example, consider the automaton $(U, \alpha) : X \rightarrow Y$ as the dynamical system $(\alpha \cdot i_U \mid i_Y) : U + Y \rightarrow U + Y$, where $\alpha \cdot i_X : X \rightarrow U + Y$ defines the set of starting states and Y is the set of equilibrium states of the system. The following ‘cobordism’ picture illustrates the features of an Elgot automaton.

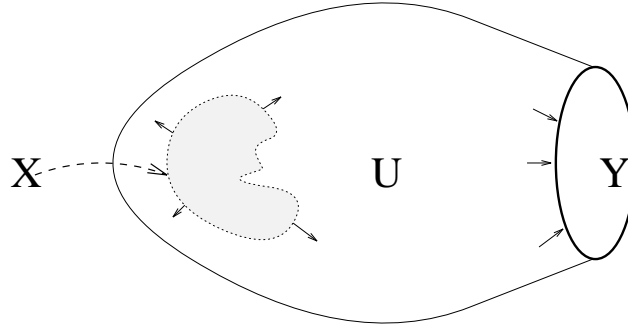

The diagram indicates there is a vector-field on the state-space of the system governing the motion of the automaton. While the map with domain X (determining the initial states) is arbitrary, the inclusion of the final states Y is co-fibrant. In fact, via Grothendieck's generalization of the semi-direct product construction, each Elgot automaton $(U, \alpha) : X \rightarrow Y$ in **Set** gives rise to a cospan $\overline{X} \rightarrow \overline{U+Y} \leftarrow \overline{Y}$ in **Cat**: \overline{X} and \overline{Y} are the discrete categories with object-sets X and Y respectively; $\overline{U+Y}$ is the category obtained by applying the Grothendieck construction to the presheaf $((\alpha \cdot i_U \mid i_Y) : U+Y \rightarrow U+Y) \in \mathbf{Set}^{\mathbf{N}}$; the functor $\overline{X} \rightarrow \overline{U+Y}$ is determined by the function $\alpha \cdot i_X : X \rightarrow U+Y$; and $\overline{Y} \rightarrow \overline{U+Y}$ is determined by the injection $i_Y : Y \rightarrow U+Y$. The functor $\overline{Y} \rightarrow \overline{U+Y}$ is a cofibration in the sense of [10].

As is indicated by the above picture, there may be problems with feeding back an Elgot automaton if the input is mapped onto the output. This problem can be avoided by delaying either the input or the output of the process, since, as was the case with circuits, if $(U, \alpha) : X \oplus Y \rightarrow Z \oplus Y$ is an Elgot automaton, Y can be fed back in either ${}_Y(U, \alpha)$ or $(U, \alpha)_Y$. In terms of cobordism pictures, it would be fair to represent delaying a process by the addition of a tube: we could draw $(U, \alpha)_Y : X \oplus Y \rightarrow Y \oplus Z$ as

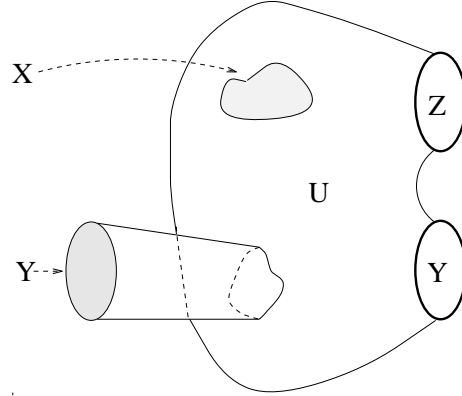

and $\text{fb}_{X,Z}^Y((U, \alpha)_Y) : X \rightarrow Z$ as

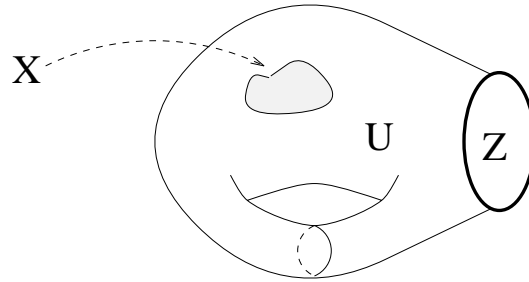

By a behaviour of the Elgot automaton $(U, \alpha) : X \rightarrow Y$ we mean a behaviour of the dynamical system $(\alpha \cdot i_U \mid i_Y) : U + Y \rightarrow U + Y$ that starts in X – that is, a sequence $(s_i)_{i \in \mathbb{N}} \in (U + Y)^{\mathbb{N}}$ together with $x \in X$ such that $s_0 = \alpha \cdot i_X(x)$ and $(\alpha \cdot i_U \mid i_Y)(s_i) = s_{i+1}$. In fact, by drawing the Elgot diagram for an expression in **Elgot(Set)**, a particular state of the system can be visualized as lying in one of the components of the diagram. In this sense, it is useful to think of a behaviour of the circuit as the behaviour of a pulse that enters the device at the input wires and then moves according to the dynamical laws given above, perhaps exiting the device at one of the output wires. Viewing an infinitesimal in this way, we see that a pulse entering the device will instantaneously exit on an output wire. It is, however, simpler to consider the input-output behaviour of an Elgot automaton.

6.3 Input-output behaviours of Elgot automata

In order to define the input-output behaviour of an Elgot automaton, the locally-ordered bicategory of sets and partial functions needs to be introduced. Bicategories of partial maps were defined in [5] and, as pointed out there, can be constructed from left exact categories. Left exactness, however, is not enough to equip the resulting bicategory of partial maps with a trace. Certainly, any topos will suffice. We content ourselves here with using sets and functions.

Definition 8 The following data defines **Par**, the locally ordered category of sets and partial functions.

- An object in **Par** is a set.
- An arrow from X to Y in **Par** is an isomorphism class of spans from X to Y of the form (i, U, f) , where $i : U \rightarrow X$ is a monomorphism. The equivalence class to which (i, U, f) belongs will be written as $[i, U, f]$.
- There is a 2-cell from $[i, U, f] : X \rightarrow Y$ to $[j, V, g] : X \rightarrow Y$ if and only if there is a 2-cell in **Span** from (i, U, f) to (j, V, g) . Note that if such a 2-cell in **Span** exists, it is unique; in this case, we write $[i, U, f] \leq [j, V, g]$.

Identities and compositions of arrows and 2-cells are inherited in the obvious way from **Span**.

The coproduct in **Set** induces a tensor product on **Par**, which is also a coproduct. Explicitly, $[i, U, f] + [j, V, g] = [i + j, U + V, f + g]$.

With respect to the coproduct, **Par** may be equipped with a traced monoidal structure. Given a partial function $[j, U, g] : X + Y \rightarrow Z + Y$, we define $\text{Tr}_{X,Z}^Y [j, U, g] : X \rightarrow Z$ as follows. (Of course, this operation Tr is not the same as the trace defined for (\mathbf{Rel}, \otimes) in the previous section.)

First form the coequalizer

$$U \begin{array}{c} \xrightarrow{i_{Z+Y} \cdot g} \\ \xrightarrow{i_{X+Y} \cdot j} \end{array} X + Y + Z \xrightarrow{q} Q.$$

The claim is that $q \cdot i_Z : Z \rightarrow Q$ is a monomorphism. Assuming this and taking the pullback

$$\begin{array}{ccc} P & \xrightarrow{\pi_1} & X \\ \pi_2 \downarrow & & \downarrow q \cdot i_X \\ Z & \xrightarrow{q \cdot i_Z} & Q \end{array}$$

yields a partial function $[\pi_1, P, \pi_2] : X \rightarrow Z$. We take this to be $\text{Tr}_{X,Z}^Y[j, U, g]$.

Now, let us show that $q \cdot i_Z$ is a monomorphism. First, let \dashv be the relation on $X + Y + Z$ defined by: $a \dashv b$ if and only if there exists $u \in U$ such that $i_{Z+Y} \cdot g(u) = a$ and $i_{X+Y} \cdot j(u) = b$. If \approx is the symmetric relation generated by \dashv , Q is isomorphic to the set $(X + Y + Z) / \sim$, where \sim is the smallest equivalence relation containing \approx .

We want to show that if $z, z' \in Z$, $z \sim z'$ implies $z = z'$. Let $\alpha = i_{Z+Y} \cdot g$ and $\beta = i_{X+Y} \cdot j$. Supposing $z \sim z'$, we know there exists $a_0, \dots, a_n \in X + Y + Z$ such that $z = a_0 \approx \dots \approx a_n = z'$. (We call this a chain from z to z' .)

If $n = 0$, $z = z'$. If $n = 1$, there exists $u \in U$ such that $\beta(u) = z$ or $\beta(u) = z'$; this is clearly impossible since $\beta(u) \in X + Y$. If $n = 2$, there exists $u_1, u_2 \in U$ such that $z = \alpha(u_1)$, $a_1 = \beta(u_1)$, $a_1 = \beta(u_2)$ and $z' = \alpha(u_2)$. Since β is injective, $u_1 = u_2$ and, therefore, $z = z'$.

Suppose $n \geq 3$. Then there exists $u_1, \dots, u_n \in U$ such that $\alpha(u_1) = z$, $\alpha(u_n) = z'$ and, for all $i \in \{2, \dots, n-1\}$, either $\alpha(u_i) = a_i$ and $\beta(u_i) = a_{i-1}$ or $\alpha(u_i) = a_{i-1}$ and $\beta(u_i) = a_i$. Clearly there exists $i \in \{2, \dots, n-1\}$ such that $\beta(u_{i-1}) = a_{i-1} = \beta(u_i)$, implying $u_{i-1} = u_i$ and $a_{i-2} = \alpha(u_{i-1}) = \alpha(u_i) = a_i$. Thus, $z = a_0 \approx \dots \approx a_{i-2} \approx a_{i+1} \approx \dots \approx a_n = z'$. By induction on the length of the chain from z to z' , we have that $z = z'$. So $\text{Tr}_{X,Z}^Y[j, U, g]$ is well-defined.

For example, given $[1_{X+Y}, X + Y, g] : X + Y \rightarrow Z + Y$, calculate $\text{Tr}_{X,Z}^Y[1_{X+Y}, X + Y, g] : X \rightarrow Z$. A moment's thought will verify that $\text{Tr}_{X,Z}^Y[1_{X+Y}, X + Y, g] = [\pi_1, P, \pi_2]$, where

$$P = \{(x, z) \in XZ \mid \exists n \in \mathbb{N} \text{ such that } (i_{Z+Y} \cdot g \mid i_Z)^n(x) = z\}.$$

We have claimed that Tr is a trace for $(\mathbf{Par}, +)$. In fact, it was shown in [12] that $(\mathbf{Rel}, +)$ is a traced monoidal category, and it is clear that, with

respect to the canonical inclusion $\mathbf{Par} \rightarrow \mathbf{Rel}$, the trace that was there defined for $(\mathbf{Rel}, +)$ restricts to the trace we have just defined for $(\mathbf{Par}, +)$.

We are now in a position to prove the main result of this section which will clarify our earlier remark regarding the input-output behaviour of an Elgot automaton.

Theorem 3 *The data*

$$\begin{aligned} \text{I/O} &: \mathbf{Elgot}(\mathbf{Set}) \longrightarrow \mathbf{Par} \\ &: X \longmapsto X \\ &: (U, \alpha) : X \rightarrow Y \longmapsto \text{Tr}_{X,Y}^U[1_{X+U}, X + U, c_{U,Y} \cdot \alpha] \end{aligned}$$

defines a tensor product and feedback preserving homomorphism of bicategories.

Proof. First, let us see why I/O is defined on 2-cells. Let $\theta : (U, \alpha) \Rightarrow (V, \beta) : X \rightarrow Y$ be a 2-cell in $\mathbf{Elgot}(\mathbf{Set})$. Remember that this means the diagram

$$\begin{array}{ccc} X + U & \xrightarrow{\alpha} & U + Y \\ X + \theta \downarrow & & \downarrow \theta + Y \\ X + V & \xrightarrow{\beta} & V + Y \end{array}$$

commutes. The universal property of the two coequalizers

$$\begin{array}{ccc} X + U & \begin{array}{c} \xrightarrow{i_{X+U}} \\ \xrightarrow{i_{U+Y} \cdot \alpha} \end{array} & X + U + Y \xrightarrow{q} Q \\ X + V & \begin{array}{c} \xrightarrow{i_{X+V}} \\ \xrightarrow{i_{V+Y} \cdot \beta} \end{array} & X + V + Y \xrightarrow{q'} Q' \end{array}$$

guarantee the existence (and uniqueness) of $\bar{\theta} : Q \rightarrow Q'$ such that $\bar{\theta} \cdot q = q' \cdot (X + \theta + Y)$. Therefore, $q' \cdot i_X = \bar{\theta} \cdot q \cdot i_X$ and $q' \cdot i_Y = \bar{\theta} \cdot q \cdot i_Y$. Now, consider the pullback diagrams

$$\begin{array}{ccc} P \xrightarrow{\pi_1} X & & P' \xrightarrow{\pi'_1} X \\ \pi_2 \downarrow & \downarrow q \cdot i_X & \pi'_2 \downarrow & \downarrow q' \cdot i_X \\ Y \xrightarrow{q \cdot i_Y} Q & & Y \xrightarrow{q' \cdot i_Y} Q' \end{array}$$

Since $\bar{\theta} \cdot q \cdot i_X \cdot \pi_1 = \bar{\theta} \cdot q' \cdot i_Y \cdot \pi_2$ we have $q' \cdot i_X \cdot \pi_1 = q' \cdot i_Y \cdot \pi_2$. By the universal property of pullbacks there exists a unique $h : P \rightarrow P'$ such that $\pi'_1 \cdot h = \pi_1$ and $\pi'_2 \cdot h = \pi_2$. Thus,

$$I/O(U, \alpha) = [\pi_1, P, \pi_2] \leq [\pi'_1, P', \pi'_2] = I/O(V, \beta).$$

The traced monoidal properties (for **Par**) are all that is needed for proving that **Int** preserves composition, tensor products and feedback. The fact that the monoidal structure in this case is symmetric (rather than balanced) greatly simplifies calculations.

Note that the canonical functor **Set** \rightarrow **Par** preserves sums. Thus, the preservation by *I/O* of i) composition, ii) tensor products and iii) feedback correspond to the following easily verified equalities of string diagrams. (These diagrams are to be read from bottom to top, as in [12].)

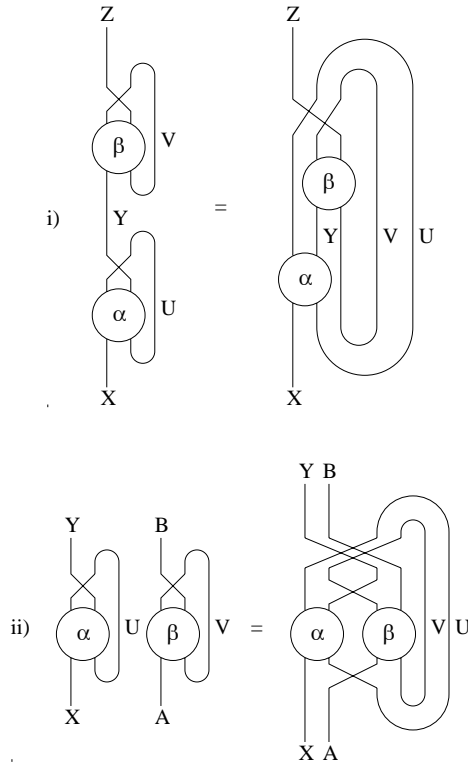

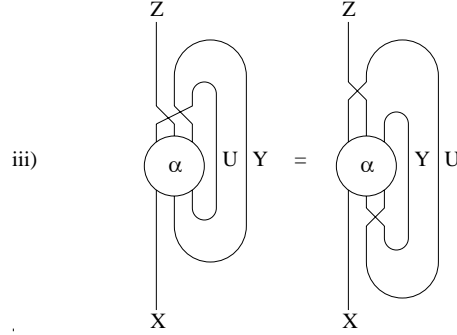

□

The term I/O is an abbreviation of the phrase input-output. Considering the starting states as inputs and the final states as outputs, the construction I/O abstracts from an Elgot automaton the input-output aspect of its behaviours. The interpretations we give here to the terms input and output are different to those given in the sections on circuits. For example, an input for a circuit can be viewed as an action on the internal state, while an input for an Elgot automaton is an initial condition. Both these points of view are encompassed within the general notion of a process in a symmetric monoidal category.

The structure preserving homomorphism I/O indicates there is a close relation between our theory of bicategories of Elgot automata and the iteration theories of Bloom and Elgot ([3]) which attempt to capture the equational properties of the fixed-point operator in categories such as **Par**.

7 Final remarks

The reader familiar with concurrency may ask: what bearing does this theory of processes have on the study of distributed systems? The present paper provides a basis for developing a deeper theory of input-output systems. By no means have the definitions in this paper exhausted the notion of process. Other examples of processes have been studied in [15] in order to model asynchronous circuits. In fact, the sequel to this paper will investigate processes in a distributive category (admixture of circuits and Elgot automata), structures that are related to the notion of an imperative program as defined

in [17]. This is a key to understanding questions of independence and state reduction in complex systems ([9],[14],[18]).

Also relevant to the analysis and design of distributed systems are the notions of abstraction and refinement. As both these terms refer to the comparison of an abstract model with a more concrete one, it is clear that the 2-cells of bicategories of processes are essential to the mathematical modelling of these concepts. The relationship between these ideas and those developed in [7] will bear closer examination.

References

- [1] Abramsky S., Interaction Categories, in: Theory and Formal Methods Workshop (Springer, 1993).
- [2] Bénabou J., Introduction to bicategories, in: Lecture Notes in Mathematics, Vol. 47 (Springer, Berlin, 1967) 1-77.
- [3] Bloom S. L. and Esik Z., Iteration Theories, EATCS, (Springer-Verlag, 1991).
- [4] Brown C. and Jeffrey A., Allegories of circuits, in: Proc. Logical Foundations of Computer Science (St. Petersburg, 1994).
- [5] Carboni A., Bicategories of partial maps, Cahiers-Topologie-Geom.-Differentielle-Categoriques 28 (1987) no. 2, 111-126.
- [6] Carboni A. and Walters R. F. C., Cartesian Bicategories I, JPAA 49 (1987) 11-32.
- [7] Cockett J. R. B. and Spooner D. A., SProc Categorically, in: Proceedings CONCUR'94 (Springer-Verlag, 1994).
- [8] Elgot C., Monadic computation and iterative algebraic theories, Studies in Logic and the Foundations of Mathematics 80, (1975) 175-230.
- [9] Godefroid P. and Pirottin D., Refining Dependencies Improves Partial-order Verification Methods, in: LNCS 697 (Springer, 1993) 438-449.

- [10] Gray J. W., Fibred and Cofibred Categories, in: Proc. Conf. Categorical Algebra (Springer, 1966) 21-33.
- [11] Jones G. and Sheeran M., Circuit design in Ruby, in: Formal methods for VLSI design (North-Holland, 1990) 13-70.
- [12] Joyal A., Street R. H. and Verity D., Traced Monoidal Categories, Macquarie Mathematics Report No. 94-156 (August 1994).
- [13] Khalil W. and Walters R. F. C., An imperative language based on distributive categories II, in: Informatique Theorique et Applications (1993).
- [14] Mazurkiewicz A., Traces, Histories and Graphs: Instances of a Process Monoid, in: Mathematical Foundations of Computer Science LNCS 176 (Spinger, 1984) 115-133.
- [15] Sabadini N., Walters R. F. C. and Weld H., On distributive automata and asynchronous circuits, Technical Report 93-29, University of Sydney (September 1993) CTCS93, Amsterdam.
- [16] Shields M. W., An Introduction to Automata Theory (Blackwell Scientific Publications, 1987).
- [17] Walters R. F. C., Categories and Computer Science (Carslaw Publications 1991, and Cambridge University Press, 1992).
- [18] Zielonka W., Notes on Finite Asynchronous Automata, RAIRO Informatique Theorique et Applications 21, 99-135.