

Harnessing Tidal Energy Using Vertical Axis Tidal Turbine

Syed Shah Khalid, Zhang Liang and Nazia Shah

College of Shipbuilding Engineering, Harbin Engineering University, Harbin, 150001, China

Abstract: An overview of the current design practices in the field of Renewable Energy (RE) is presented; also paper delineates the background to the development of unique and novel techniques for power generation using the kinetic energy of tidal streams and other marine currents. Also this study focuses only on vertical axis tidal turbine. Tidal stream devices have been developed as an alternative method of extracting the energy from the tides. This form of tidal power technology poses less threat to the environment and does not face the same limiting factors associated with tidal barrage schemes, therefore making it a more feasible method of electricity production. Large companies are taking interest in this new source of power. There is a rush to research and work with this new energy source. Marine scientists are looking into how much these will affect the environment, while engineers are developing turbines that are harmless for the environment. In addition, the progression of technological advancements tracing several decades of R & D efforts on vertical axis turbines is highlighted.

Keywords: Renewable energy, tidal current turbine, tidal energy, Vertical Axis Tidal Turbine (VATT)

INTRODUCTION

The oceans has a vast & largely untapped source of energy in the form of fluid flow (current, waves and tides known as hydrokinetic) thermal and salinity gradients. Numbers of ways are devised for extracting energy from these sources. These are: Ocean Thermal Energy Conversions (OTEC), Tidal power (barrage or dam) and Wave power (Kinetic hydropower).

OTEC operation relies on the basic relationship between pressure P , temperature T and volume V of a fluid and can be expressed in equation form:

$$\frac{PV}{T} = a \text{ (constant)} \quad (1)$$

So temperature difference is used to increase the pressure, this increased pressure is used to generate mechanical work. OTEC works sound when the temperature difference between the warmer, top layer of the ocean and the colder, deep ocean water is about 20°C (SOPAC, 2001). OTEC power plants require huge capital investment. Due to limited sites in tropic where deep water is close enough to make OTEC system viable. A barrage or dam is typically used to convert tidal energy into electricity, by using the potential head on opposite sides of the dam to turn the turbine. Four large-scale tidal power plants currently exist. They are the La Rance Plant (France, 1967), the Kislava Guba Plant (Russia, 1968), the Annapolis Plant (Canada, 1984) and the Jiangxia Plant (China, 1985; Gorlov,

2001). The main characteristics of these tidal power plants are given in Table 1. All existing tidal power plants use Dam or barrage can impede sea life migration, and build silt behind can affect the local ecosystems; also the construction costs are high and longer payback period. As a result, the cost per kilowatt-hour is not competitive with conventional fossil fuel power. The wave energy due to tides (rise and fall of sea level relative to the land) has been challenging the engineers & scientist for several decades. The growth in demand for RE sources makes a shift and re-starts in the late 1990s after 70s. RE like tidal power accounts for only 2.5% of the world consumption as shown in Fig. 1, but with new technology techniques, tidal power can be a useful source of energy (Nguyen, 2008).

Use of RE in the world for electricity generation grows by an average of 3.0% per year Fig. 2 and the part of RE for electricity generation increases from 18% in 2007 to 23% in 2035 (U.S. Energy Information Administration, 2010).

Hydroelectric and wind power are main sources of RE of world electricity needs. Of the 4.5 trillion kilowatt hours of increased renewable production over the projection period, 2.4 trillion kilowatt h (54%) is credited to hydroelectric power and 1.2 trillion kilowatt h (26%) to wind (U.S. Energy Information Administration, 2010). Renewable other than hydroelectricity and wind-including solar, geothermal, biomass, waste and tidal/wave/oceanic energy do increase at a rapid rate over the projection period Fig. 3. The tidal stream power density is the kinetic energy of

Table 1: Large tidal power plants in the world

Country	Site	Power (MW)	Basin area (km ²)	Mean tide (m)
France	La Rance	240	22	8.55
Russia	Kislaya Guba	0.4	1.1	2.30
Canada	Annapolis	18	15	6.40
China	Jiangxia	3.9	1.4	5.08

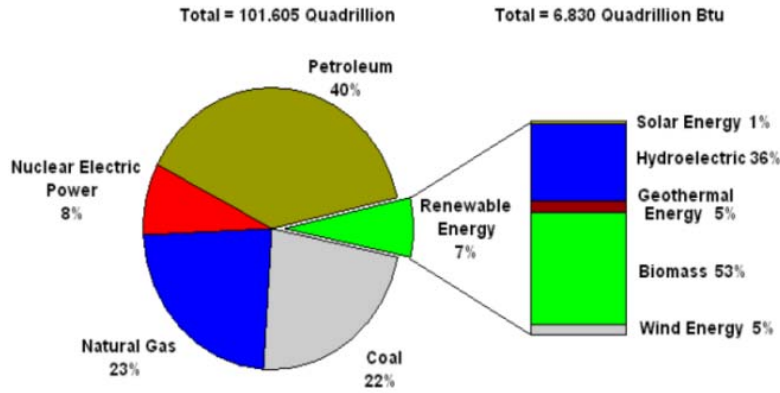

Fig. 1: 2007 chart report of the world energy consumption

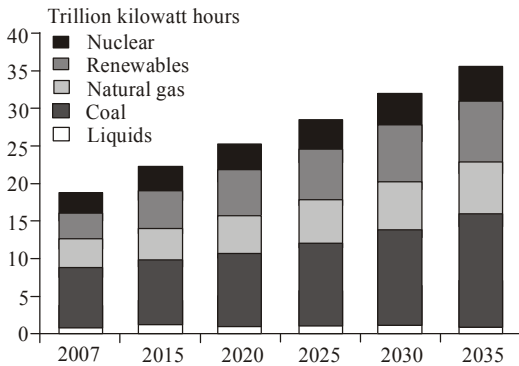

Fig. 2: World net electricity generation by fuel

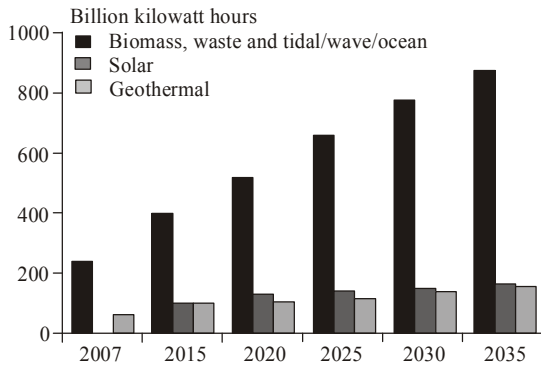

Fig. 3: World renewable electricity generation by tidal/wave/ocean

the fluid. The power P_t available from a stream of water is (Hardesty, 2009):

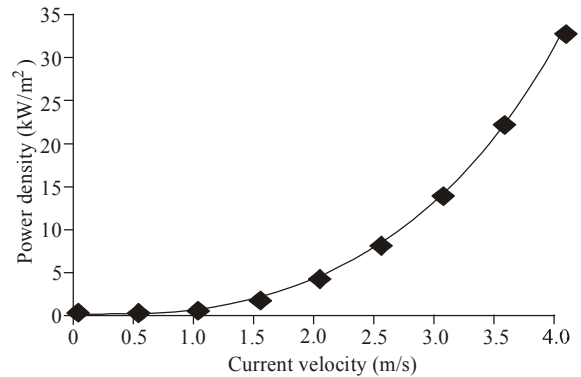

Fig. 4: Power density and current velocity

$$P_t = \frac{1}{2} \rho A V^3 \quad (2)$$

where,

- ρ : The density of water
- A : The cross-sectional area of the rotor
- V : The free-stream velocity of the current

The relationship shows that power and hence energy capture are highly dependent on velocity. It increases quite rapidly with current speed. Figure 4 show the sensitivity of the power calculation to the current speed selected (EPRI-Tidal power production guidelines).

Unlike wind turbine design, which is renowned technology, tidal current turbine design is still at an early stage of development. The Blade Element Momentum model proposed, by Burton *et al.* (2001), can be used for the hydrodynamic design of the turbine

blades, as described by Batten *et al.* (2008) and effectively compared with experiment by Bahaj *et al.* (2007).

The category of tidal turbine employed can be characterized by its rotational axis orientation with regard to the water flow direction. The Axial Flow Water Turbine (AFWT) has an axis of rotation parallel to the current direction and its rotor must be controlled to follow the current direction, if the rotational axis is perpendicular to the current, the turbine operates whatever the flow direction. This class of turbine is known as Cross Flow Water Turbine (CFWT). This type of turbines has several advantages, but the design is intricate (Zanette *et al.*, 2010). During literature survey it was found that no specific studies on vertical axis tidal turbine exist. All studies focus both horizontal and vertical axis. In this study only vertical axis turbine is focused also the main aspect of CFWT for use in river environment are discussed like; rotor-blade assembly, support structure, mooring system, connecting arm, rings, etc. Furthermore, some of the famous CFWT models are focused by Darrieus (1931), Gorlov (1997), Achard and Maitre (2004) and Zanette *et al.* (2010).

FUNDAMENTAL THEORIES

Fluid mechanics: Integral form of momentum equation is one of the basic equations of fluid mechanics, used to evaluate unknown forces when velocity is given at the control surface. It is obtained by applying Newton's second law, that states "the momentum at any point changes as a result of the forces acting on the fluid at that point," to a control volume. In Equation form:

$$\frac{d\vec{P}}{dt} = \vec{F} = \frac{\partial}{\partial t} \iiint \rho \vec{V} d(vol) + \iint \vec{V} \rho \vec{V} \cdot \vec{dA} \quad (3)$$

If used in combination with the control volume stresses, evaluated using Stoke's Hypothesis, the Momentum integral equation can be used to derive Navier Stokes Equations. Navier Stokes Equation in integral moment of momentum form is Anderson (2002); these two mathematical equations are used to obtain the thrust and torque of a rotor:

$$\vec{M} = \iint \vec{r} \times \vec{v} \rho \vec{V} \cdot \vec{dA} \quad (4)$$

Boundary layer and viscosity: When considering the fluid flow around the turbine blade boundary layer theory is used. This concept was introduced by Ludwig Prandtl in 1904. Fluid immediately adjacent to the surface stick to the surface due to frictional effects in other words, he assumed no slip condition at the surface-and that frictional effects were experienced

only in a boundary layer, a thin region near the surface. Outside the boundary layer, the flow was essentially the in viscid flow for a large Reynolds number. Two types of boundary layer may exist at a solid object's surface: laminar and turbulent. When the flow is smooth and steady is known as laminar flow and when it is fluctuating and agitated is known as turbulent flow. Reynolds number decides the transition state. The mathematical solution for laminar flow is easy to solve for blade aerofoil theory but complex for turbulent flow. Surface roughness and curvature (or camber) effects the position of switch from laminar to turbulent boundary layer flow. Similarly an increase in surface curvature promotes boundary layer separation (White, 1982).

The betz limit: According to Betz's law, no turbine can capture more than 59.3% of the kinetic energy in wind. The ideal or maximum theoretical efficiency n_{max} (also called power coefficient) of a wind turbine is the ratio of maximum power obtained from the wind to the total power available in the wind. The factor 0.593 is known as Betz's coefficient. It is the maximum portion of the power in a wind stream that can be extracted (Gorlov, 2001). Power coefficient = $C_{Po} = (\text{power output from wind machine}) / (\text{power available in wind})$:

$$C_{Po} = \frac{\text{Power}}{\frac{1}{2} \rho V^3 A} \quad (5)$$

where,

V : The velocity of the flow

A : The swept area of the rotor

ρ : The density of water

Betz Law's is applicable equally to both wind and tidal turbine. The tidal current exerts drag & lift forces on the turbine blades, depending upon the shape and orientation of the turbine blades, these forces exert a rotary torque onto the shaft which then drives electrical generation plant through fixed or variable gearboxes.

Blade hydrofoil: The front edge of the blade is called the leading edge or nose and the other end is the trailing edge or tail. The point at which these two edges meet is called the blade tip. The straight line between the leading and trailing edge of the profile is known as chord line and the distance between nose and tail is the chord length 'c' of the foil. Generally the local coordinate system is taken at the leading edge. The x-direction is toward the tail, the y-direction is upward, perpendicular to the chord. The angle between the nose-tail line and the flow is the angle of attack, α (Justin, 2001). As shown in Fig. 5, a foil section can be thought of as the combination of a mean line, $f(x)$ with maximum value f_0 and a symmetrical thickness form,

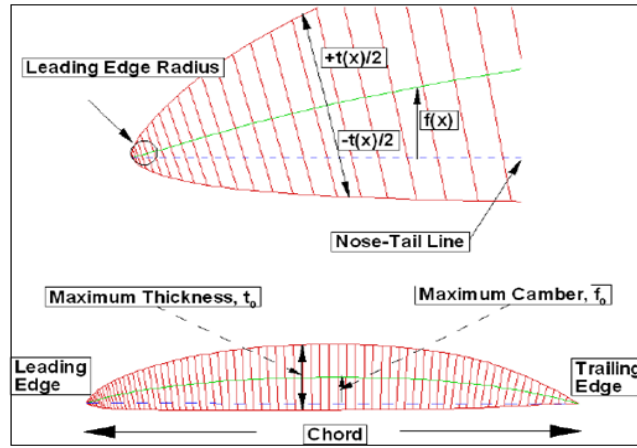

Fig. 5: Illustration of notation for foil section geometry

$t(x)$, with maximum value to. The quantity f_0/c is called the camber ratio and t_0/c is called the thickness ratio. The use of ‘Blade Element Momentum Method’ is well used by author ‘David Charles’ in his study on ‘Prediction of the Performance of a Contra-rotating Tidal Turbine’. He showed that how the lift & drag force are acting on the blade and how the resultant of these forces can be calculated (David, 2009).

The geometry of rotor blade is quite critical with respect to the occurrence of cavitations. Therefore, a specific rotor blade assembly is generally designed for the specific environment and conditions. The thrust and the speed of turbine, is controlled by the rotor rotational speed-often called revolutions per minute (rpm).

Cavitation: Cavitation is a problem for all marine platforms. It occurs when the blade surface pressure falls below the vapor pressure of water, causing bubbles to form and then quickly collapse; the problem is encountered near the water surface, where static pressure is lowest. Blade erosion and potential fatigue damage take place. Therefore the blade pitch angle must be altered such that the blade remains below the critical cavitation pressure in all flow regimes (Journé and Massie, 2001). A cavitation number σ is defined as:

$$\sigma = \frac{P_{atm} + \rho gh - P_v}{0.5 \rho V^2}, C_p = \frac{P_L - P_0}{0.5 \rho V^2} \quad (6)$$

and the pressure coefficient (C_p) as, where, P_L is the blade local pressure and V the stream velocity relative to the blade. The choice of blade section can be important when considering cavitation. NACA 63-8xx sections have been used by the author in his study of ‘Hydrodynamic performance of marine current turbine’ (Batten *et al.*, 2008). Cavitation tests for this and

alternative 2D sections with 15% thickness chord ratio are reported in Molland *et al.* (2004) and Wang *et al.* (2007a) performed an experimental study on cavitation, noise and slipstream characteristics of an ocean stream turbines. He proved experimentally that in existence of cavitation, noise level increases.

Structure classification based on hydrodynamics:

Both viscous and potential flow effects may be used in evaluating the wave induced motions and loads on marine structures. Wave diffraction and radiation around the structure are included in potential flow. In order to examine when viscous effects or potential flow effects are important, it is useful to refer to Fig. 6. This diagram is based on result for horizontal wave force on a vertical circular cylinder standing on the sea floor and penetrating the free surface. The waves are regular. H is wave height and λ is the wavelength of incident waves. D is the cylinder diameter. The results are based on the use of Morison’s equation with mass coefficient of 2 and drag coefficient of 1. The linear McCamy and Funchs (1954) theory has been used in the wave diffraction regime (Faltinsen, 1990). For an extreme condition when H (30 m) and λ (300 m), considering wave loads on the caisson of a gravity platform with cross-sectional dimension is 100 m. This implies H/D - and λ/D -values of 0.2 and 3, respectively. This means that wave diffraction is most important. If we consider the column of a semi-submersible, a relevant diameter would be 10 m. This implies $\lambda/D = 3$, $H/D = 3$, which means that the hydrodynamic forces are mainly potential flow forces. Wave diffraction and viscous forces are of less significance. For the legs of a jacket a relevant diameter is approximately 1 m. Figure 6 gives us only a rough classification.

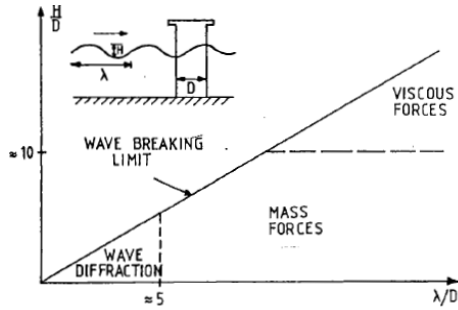

Fig. 6: Effect of mass, viscous drag and diffraction forces on marine structures

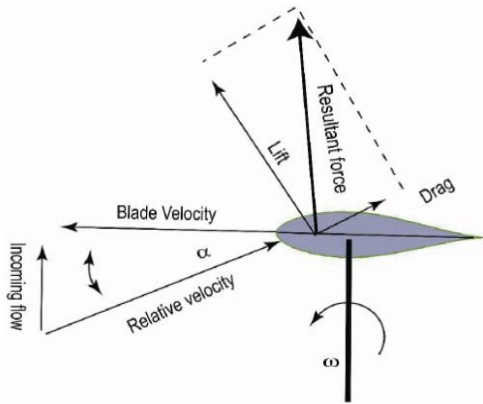

Fig. 7: Turbine working principle (plan view)

Hydrodynamics of a vertical axis tidal turbine: The power output of a turbine can be obtained by calculating lift & drag based on the vortex theory as describe by Li and Calisal (2007) for single turbine and also for turbine farm (Li *et al.*, 2007). The resultant is the summation of lift & drag force shown in Fig. 7. Its projection on blade chord line is called tangential force. Tangential force and the lift force have the same direction on blade chord line that is why the vertical axis tidal turbine is a lift driven turbine. Lift (L) and drag (D) can be expressed in terms of lift and drag coefficient as:

$$L = \frac{1}{2} \rho C_L c U_r^2, D = \frac{1}{2} \rho C_D c U_r^2 \quad (7)$$

where, C_D , C_L , U_r and c denotes the drag coefficient, the lift coefficient, relative velocity and the blade chord length, respectively. The relative velocity can be obtained by using the Biot-Savart Law ‘to calculate the velocity field induced by the three dimensional wake vortices’:

$$U_r = - \frac{\Gamma}{4\pi} \int \frac{R \times dl}{R^3} \quad (8)$$

where,
 R : The position vector

dl : Differential line element along vortex
 Γ_B : The strength of blade

These wake vortices can be obtained by differentiating the blade bound vortices at each time step which is used to represent the turbine’s blade element. The strength of these blade bound vortices can be obtained by using Kutta-Joukowski law as follows:

$$\Gamma_B = \frac{1}{2} C_L c U_r \quad (9)$$

Lift and drag forces are calculated at each time step to obtain the tangential force, F_t , with which, the mechanical power output of the turbine can be obtained as follows; where, θ , F_t and r denote the turbine azimuth angle, the tangential force and the turbine radius, respectively (Newman, 1935):

$$P_m = F_t r \frac{d\theta}{dt} \quad (10)$$

Explanation of cross flow water turbine: If the rotational axis of turbine rotor is perpendicular to the water surface, such turbines are named vertical turbine. For shallow water head applications CFWT are most efficient and suitable. According to blade pitch the vertical axis turbine can be classified in to two parts: Fixed pitch blade and Variable pitch blade. In fixed pitch blade the blades are fixed and cannot be adjustable. These blades sections are similar to those airfoils, operating at some angle of attack in the flow. The thrust and the speed of turbine are controlled by the rotor rotational speed-often called revolutions or rpm. Adjustable pitch blade, thrust is controlled by changing the pitch of the blades. The shaft often has a constant rotational speed. It is also effective when rapid maneuvering is required. The advantage of variable pitch blade is: lower rotational speed and lower swept depth range, hence reduce cavitation; also the energy capture doesn’t depend on flow direction. Sketch of vertical axis turbine is shown in Fig. 8.

In its simplest form a tidal current turbine consists of a number of blades attached to the hub (together known as rotor), which is attached to the shaft with connecting arms. Arms affects the power output of a turbine by adding additional drag on the turbine and inducing hydrodynamic interactions among arms, shaft and blades. The relative velocity between the turbine blades and the water is called tip speed ratio λ and can be defined as:

$$\lambda = \frac{\Omega r}{v}, \sigma = \frac{c N}{2\pi r} \quad (11)$$

v : The velocity of the fluid
 Ω : The angular velocity of the turbine
 R : The turbine radius

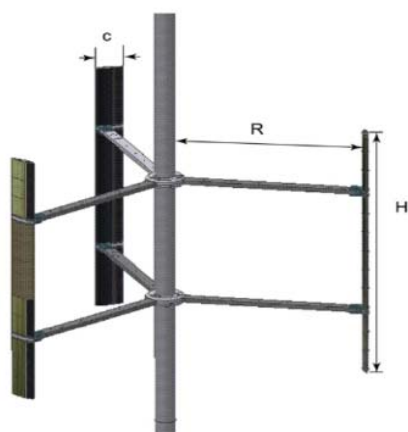

Fig. 8: The schematic of a VATT
H: turbine height; R: turbine radius; c: blade chord length; Li and Calisal (2010)

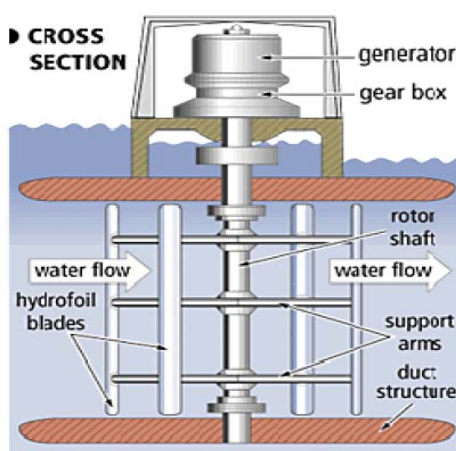

Fig. 9: Blue energy's international vertical axis turbine

Power coefficient of the turbine varies with the tip speed ratio. Another characteristic is the turbine solidity σ , a lower solidity requires less material and more cost effectual. Consul *et al.* (2009) studies the effect of solidity on the performance of CFWT. Solidity is defined by Eq. (11), where N , c and r are the number of blades, the blade chord length and the turbine radius, respectively. The study showed that increasing the number of blades from two to four resulted in an increase in the maximum power coefficient from 0.43 to 0.53. By using a perturbation theory, e.g., (Van Dyke, 1975) we can calculate the power coefficient of a turbine as follows:

$$C_P = C_{P,B} + C_{P,AS} + C_{P,INT} \quad (12)$$

where, C_{PB} , $C_{P,AS}$ and $C_{P,INT}$ denote the power coefficients contributed by the blades, the arms and

shaft and the interactions among blade, arms and shaft, respectively. A generator is a device which converts mechanical energy into electrical energy with the use of magnetic induction. Two main types of generators are Alternating Current and Direct Current generator. More detail can be seen in a reference Rourke *et al.* (2010a) and Grabbe (2008). The generator is attached to the one side of the shaft with the help of gear-box as shown in Fig. 9. Study on generator selection for Wave Energy Converter System is done by Osa Amilibia and Aio (2010). The gearbox is used to convert the rotational speed of the rotor to the desired output speed of the generator shaft.

A supporting structure is required to support these three parts as discussed above. Basically there are three types of support structures. The first is known as a Gravity Structure which consists of a large mass of concrete and steel attached to the base of the structure to achieve stability (Sustainable Energy Ireland Report). The second alternative is known as a Piled Structure which is pinned to the seafloor using one or more steel or concrete beams. The third option is known as a Floating Structure. The floating structure is usually moored to the seafloor using chains or wire (Rourke *et al.*, 2010b). Various authors describe the support structure in their research like (David, 2009). Ocean University of China (Bernad *et al.*, 2008) has designed a floating moored platform structure for 5 kW VATT. They used SESAM software for stability design for pitch and rolling movements and tested in a real sea environment. Some new concepts on the structures like Sheath system, buoyed system etc., is presented in a study by Orme and Masters (2010).

Modeling techniques for cross flow water turbine:

Based on basic theories of fluid mechanics and CFD techniques VATT can be modeled using stream-tube model or vortex system. Stream-tube requires less computation while the vortex system is an accurate one. Ponta (2001) studies the aerodynamics of Darrieus turbines by integrating the classic free vortex model with a finite element analysis of the flow in the vicinity of the blades. Free vortex model combined with finite element analysis (FEVDTM) is used to improve the Darrieus models moreover the results are compared with experimental values. Wang *et al.* (2007b) uses 2-D potential flow Vortex Panel Model (VPM2D), for unsteady hydrodynamics calculation of vertical axis straight blade variable pitch turbine. The method is based on the surface distribution of singularity elements to fulfill the boundary conditions on the actual surface of turbine blades. The research on the VATT is in its initial stage lot of engineers and researches are trying to improve the models to get maximum power output. The study of tidal turbine is incomplete without discussing

Table 2: Structure and dimension of darriues unit

Parameter	Magnitude
Height	4.2 m
Total weight	3.9 t
Turbine	Darriues type (3-blades)
Blade type	NACA6330018
Generated rotation	525 rpm

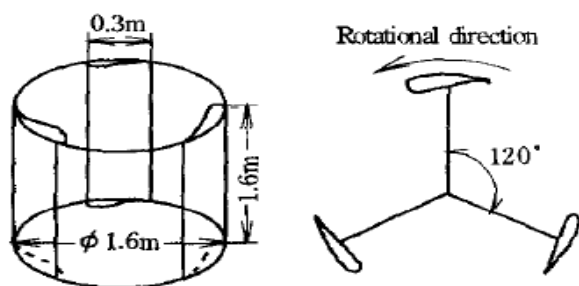

Fig. 10: Darrius turbine

the Darrius model; research is ongoing to improve the Darrius models of wind turbine. One such experimental study is carried out in Japan during 1983 to 1988 on vertical axis Darrius rotor. The power generated by this model is possible when the flow speed is 1.0 m/s (2 knots), the highest efficiency 56% of the Darrius turbine is attained at the tip speed ratio of 2.1, when tidal flow speed is 1.1 m/s (Kiho *et al.*, 1996). Dimensions of the experimental unit are listed in Table 2. Also the sketch of Darrius turbine is shown in Fig. 10.

Another similar type of study was carried out in Italy by Camporeale and Magi (2000) on vertical axis straight bladed turbine, with blades oscillating about the pivotal axis according to the Voith-Schneider system. The system acts like reversible turbo machine that can work either as a turbine or as a propeller. In the proposed model, the turbine is enclosed in a single stream tube and acting as a single disk actuator. The theoretical results are compared with experimental values. The theoretical results of model are in agreement with the experimental results. The performance hydrodynamic of the model is evaluated both in the viscous and inviscid fluids. It can be observed that, for azimuthal angles close to 90°, the angle of attack changes rapidly. Although the dynamic stall model adopted in this study may be judged inaccurate for describing the system under such a condition, considering that the tangential forces are close to zero for this azimuthal angle, the approximation does not bias the result. The experimental tests have been performed in the hydrodynamic channel of the Voith-Schneider company in Eidenheim. In the test cross-section, the hydrodynamic channel is 2.2 m wide and 1.1 m deep.

The free stream velocity is 2.2 m/s. Some of the main characteristics of this model are listed in Table 3.

A three bladed helical turbine of fiber glass with steel shaft gives best results as compared to Darrius turbine proved by US Department of Energy (Gorlov, 1998). The 3-blade turbine was mounted underneath a small raft (10×8×2ft) and reinforced by steel braces. The 1.25 inch diameter shaft of the turbine was extended upwards through the raft providing data like turbine's torque and its speed. Turbine dimensions are: Diameter-24 in, Height (Length)-34 in, Blades profile-NACA0020 with 7 in. chord. Turbine rotational speed under load was about 100 rpm.

Another study on a straight-bladed Darrius-type cross flow marine turbine is carried by Lain and Osorio (2010). CFD simulation software (Fluent. v) is used for hydrodynamic performance prediction of rotor-stator model. The main geometric data of the turbine are (radius, 450 mm). Span of straight blades (700 mm) are based on NACA0025 airfoil, profile chord, 132.75 mm, solidity 0.89. Also the numerical simulation results are compared with the experimental work carried by (Dai and Lam, 2009). Coiro *et al.* (2005) design tested and constructed the KOBOLD, vertical axis variable pitch blade turbine. The rotor is self acting with blades designed cavitation free with curved airfoil called HLIFT18 and has high lift performance.

Salter (1998) carried out a similar type of study on a large VATT, with blades oscillating by means of ring cam hydraulics. It consists of sets of symmetrical vertical blades supported at both ends by bearings in horizontal rings. The rings have streamlined elliptical sections with a chord-to-thickness ratio of five. This gives a large reduction in bending moments and bearing loads relative to a cantilevered support and allows a much greater total depth. For convenient transport in sea containers, a single blade should not exceed 10 m length and 2.4 m chord. The present choice is composed of 3 banks of 6.7 m blades with chord of 1.9 m. The rotor uses variable-pitch blades where pitch is set by control of the moment about the pitch axis. The preliminary design study suggests that cost per kilowatt falls with increasing rotor diameter to at least 100 m. Some of the main design parameters are listed in Table 4.

Salvatore *et al.* (2010) studied the hydrodynamics of Kobold VATT. Theoretical and computational methodology is based on three dimensional unsteady inviscid flows. Affect of blade pitch angle on the blade angle of attack is defined in two modes:

- **Passive mode:** In this mode the blade is free to rotate around axis between two fixed positions

Table 3: Main features of Sergio model

Parameter	Magnitude
Rotor radius	0.1 m
Blade length	0.125 m
Number of blade	4 or 5

Table 4: Main design parameters for initial design

Parameters	Magnitude
Diameter	50 m
Max stream velocity	4 m/sec
Max design stress	180 MPa
Solidity	0.121
No. of blades	10
Blade span	3×6.67 m
Chord	1.9 m
Mooring force	6.5 MN
Mooring cables	8 by 64 mm
Total weight	640 tonne
Power at 4 m/sec	12 MW

Table 5: Main parameters of the turbine/study

Parameters	Magnitude
No. of blade N	03
Dia. of turbine D_T	0.8 m
Blade chord length	0.08 m
Fixed pitch blade angle α_p	0°

- **Active mode:** In this mode the blade pitch angle is varied during a turbine revolution

His study on Kobold turbine is based on passive mode. Main specifications of the turbine are listed in Table 5, with current speed of $V_c = 0.5$ m/s and the turbine rotational speed is $n = 0.65$ rps.

Experimental work is carried on a prototype, original Kobold turbine is working in Messina strait, Italy. 1: 5 model of the turbine prototype is tested in towing tank. Net torque and power generated by the model are compared with the numerical results; hydrodynamics of the model are also visualized. Figure 11 shows the measurement set-up for experimental work.

Antheaume *et al.* (2008) studied the CFWT efficiency for a single turbine and for turbine cluster. The study consists of two parts; in the first part a single turbine for free fluid flow conditions is considered for simulation. In the second part, piling up of several turbines on the same axis of rotation to make a tower is investigated. Simulations results show increase in efficiency due to tower configuration. Several simulations have been performed by author to evaluate the increase of efficiency due to the use of towers and clusters of towers. It has been shown that the efficiency increases with the tower height and stabilizes near 8 CFWT. This case corresponds to an efficiency of 33%, 4% more than the isolated 3D CFWT. The 2D asymptotic tower gives 34.85%. Furthermore, the cluster of 2D facing towers

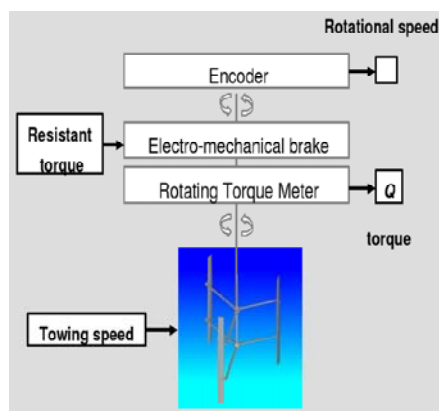

Fig. 11: (a) Turbine model in towing tank, (b) experimental set-up

separated by two turbine diameters presents an increase of efficiency that stabilizes near 10 CFWT. This case corresponds to an efficiency of 40.5%, almost 6% more than the 2D isolated tower and 11.5% more than the 3D isolated CFWT. Table 6 Illustrate for different tower configuration.

Khan *et al.* (2008) carried a research on VATT using permanent magnet generator. Rotor submersion, ripple propagation and start-up behavior are focused in his study. Three configurations of rotor models are tested i.e., rotor with 3, 4 and 6 blades. Razak *et al.* (2010) has designed and manufactured a VATT known as Pico Hydro (power less than 5 kW) System. Turbine is capable of producing 100 W dc power at the head of 1.2 m and flow rate of 20 L/s. Cost of energy per unit is less than government tariff rate. Pico hydro system consists of CFWT, a gear system, alternator, charge controller and a set of battery as storage. The runner diameter is 450 mm and the length of the blade is 300 mm. Nozzle is used to guide the water through the turbine Fig. 12.

Hwang *et al.* (2009) optimize the cycloidal VATT for improving turbine efficiency. In his research, STAR-CD program is used for CFD analysis to study

Table 6: Maximum efficiency for different tower configurations

Diff. configuration	1	2	3	4
Number of turbines	1(3D)	4	8	2D
Maximum C_p (%)*	29	32.05	33.02	34.85

*: The turbine power coefficient

Table 7: Parameters for experimental study

Parameter	Magnitude
No. of blades	3
Hydrofoil	NACA0012
Rotor radius	0.50 m
Blade span length	0.40 m
Blade chord length	0.14 m



Fig. 12: Pico hydro turbine system

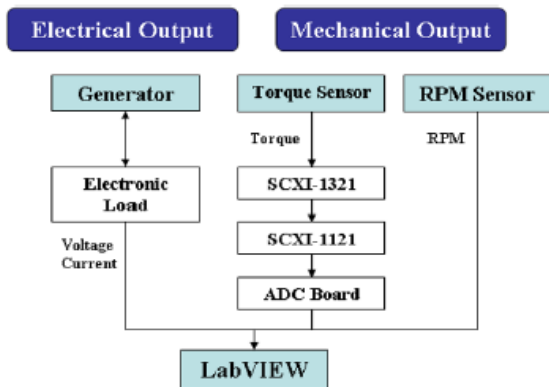

Fig. 13: Power measuring method for cycloidal turbine

the performance of the cycloidal water turbine and the optimal geometries and operating conditions were determined through parametric studies. The numerical results were compared with the experimental study. Figure 13 shows the arrangement for power calculations. Radial forces are similar in both cases but an error occurs in tangential forces. Table 7 shows, parameters considered for experimental works.

Lubing *et al.* (2004) studied VATT which works in bidirectional water flow, main advantage is that the turbine does not need pitch adjustment or yaw system. But efficiency of this system is less than horizontal axis



Fig. 14: 40 kW tidal turbine by HEU

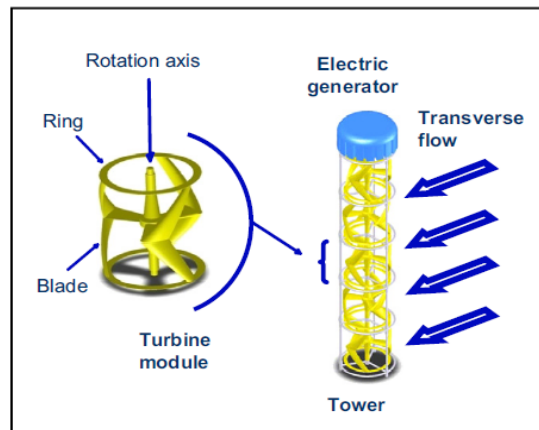

Fig. 15: Achard CFWT tower concept

turbine. Another 60 W prototype was tested by HEU in 1984. A 70 kW floating tidal energy plant and 40 kW gravity based support structure is also developed and tested by HEU during 2002 to 2005 Fig. 14. Research work is now continued on horizontal and vertical axis tidal turbines. Numerical and design work is almost completed and in near future experimental test will be performed.

Georgescu *et al.* (2010) works on Achard and Maitre turbine; his study consists of experimental and numerical investigations related to the water flow in the wake of a hydropower farm, equipped with three Achard turbines. The two dimensional numerical model of the farm has been used to depict the velocity field in the wake of the farm, with COMSOL Multiphysics and FLUENT software, to compute numerically the overall farm efficiency. The validation of the numerical models with experimental results is performed via the measurement of velocity distribution, by Acoustic Doppler Velocimetry, in the wake of the middle turbine within the farm. The Achard turbine is a new type of vertical axis, cross-flow, marine current turbine,

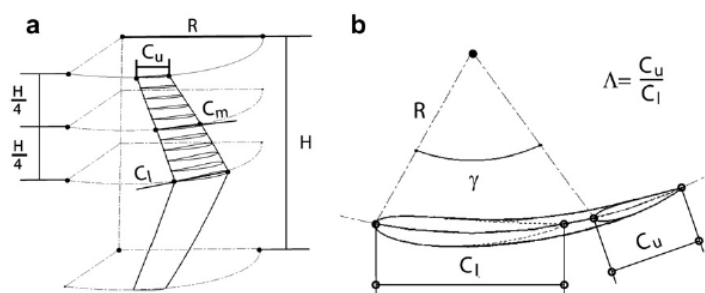

Fig. 16: (a) Side view of blade (b) top view of blade

developed since 2001 at LEGI (Geophysical and Industrial Flows Laboratory) of Grenoble, within the French HARVEST Project. That turbine has been patented by Achard and Maître.

Achard turbine description: The vertical delta blades of the Achard turbine are shaped with NACA 4518 airfoils, while the radial supports are shaped with straight NACA 0018 airfoils. At full scale, the runner diameter is $D = 1$ m and the runner height is $H = 1$ m. The VATT run in stabilized current, so the flow can be assumed to be almost unchanged in horizontal planes along the z-axis. VATT shows complex flow patterns between the blades than axial turbines. As a consequence, the lift and drag forces acting on the blades change also during a complete rotation. The total tangential force is responsible for turbine rotation. Bernad *et al.* (2008) studied the Two-dimensional numerical modeling of the unsteady flow through the blades of the Achard turbine, using Fluent 6.3 software. The main advantages of Achard turbines are their modularity and their ability to operate irrespective of the water flow direction. Thus, similar modules can be superposed to form towers and cluster of barges, with lengths adapted to current depths Fig. 15. The other advantage of this turbine is that the fatigue phenomenon is reduced due to blades not completely facing the water flow at each revolution, so turbine life is increased. Also the turbine is self starting without any external device.

Zanette *et al.* (2010) proposed an improved design methodology for CFWT of Achard & Maitre turbine. They showed that due to change trapezoidal blade geometry, the turbine efficiency is improved. Also due to variable profiled cross-section area, the intensity of cyclic loadings is reduced and improves the turbine's durability Fig. 16. The proposed non-coupled fluid-structure approach simplifies the analysis of the mechanical behavior of CFWT. Main geometric parameters of this model are shown in Table 8.

Table 8: Main features of trapezoidal model

Parameters	Magnitude
N = No. of blades	3
R = Turbine radius	250 mm
H = Turbine height	500 mm
γ = leading edge sweep angle	30°
C_u = upper chord length	61.1 mm
C_l = lower chord length	122.2 mm
Λ = extremities chord ratio C_u/C_l	0.5

COMMERCIAL LEADERS

Blue energy davis turbine: The main convertor of the Blue Energy Power System is the Davis Hydro Turbine, which is based on a patent on a vertical axis windmill by French inventor Georges Darrieus. These turbines works in a low water head, in a highly efficient manner. The turbine can be used as individual or in a tidal fence arrangement. Four fixed hydrofoil blades of the Turbine are connected to a rotor that drives an integrated gearbox and electrical generator assembly. The hydrofoil blades works on lift principal that causes the turbine foils to move proportionality faster than the speed of the surrounding water. The turbine rotates in a single direction for both ebb and flood condition of tides. A unit turbine is expected to produce 200 kW output power (Hatch Energy Report, 2008).

Coastal hydropower corp: Coastal Hydropower Corporation ("Coastal") is a Canadian company. The cross-flow turbines developed is similar to the Gorlov Helical Turbine ("GHT"). The turbine has three helical blades attached to central drive shaft via connecting arm. Due to axial symmetry the, the GHT always rotates in the same direction, even when tidal current reverses its direction. A single standard GHT rated power is 1.5 kW for 1.5 m/sec water speed and 180 kW for 7.72 m/sec. Another CFWT is a straight-bladed Darrieus turbine. The design includes a hydrofoil. In 2007 Coastal complete tests in the Campbell River area of Vancouver Island and is now preparing for the installation of 5 kW demonstration sites at locations in



Fig. 17: CFWT in diffuser mounted in front of motorized barge

Table 9: Basic parameters of turbine

Parameter	Value
Diameter (m)	5
Chord (m)	0.375
No. of blades	3
Height of blades (m)	4
Foil profile	NACA0018
Stream speed (m/s)	2.2

B.C. and Ontario. Development of a zero-head kinetic energy station on the Peace River with capacity of 10 MW is continued (Hatch Energy Report, 2008).

Lucid energy technology: Lucid energy a US based company developed the Gorlov type helical turbine. This type of turbine works in low water head, other characteristics are its flexibility that it can be arrange in any direction with common shaft for multiple turbines. It rotates in the same direction independent of the flow. A 12 kW unit was tested in the Korean Ocean from 2002-2004 (Hatch Energy Report, 2008).

New energy corporation Inc: The design of EnCurrent technology of CFWT is based on Darrieus wind turbine.

According to New Energy the EnCurrent turbine is able to extract 40 to 45% of the energy in the water moving through it. Various design configurations of the turbine including overhung, beam style, center shaft or end plate supported, fixed blade or variable pitch are possible. Depending on the flow characteristics the turbine can operate as a fixed speed machine or variable speed. The turbine rotates at a very slow speed, about 2 to 2.5 times as fast as the water, translating to between 60 and 100 RPM for small systems. Normally the turbine is suitable for flow velocities of between 1.5 and 3.5 m/s. (Hatch Energy Report, 2008).

Tidal energy systems international-Australia: Tidal Energy Systems International (Bachmann, 2011), a small Queensland company, is developing a diffuser-augmented cross flow tidal turbine. Preliminary work done in collaboration with Dr. Brian Kirke of Griffith University. Kirke B developed a Darrieus turbine of 1.2 m diameter, with fiberglass blades of 100 mm chord length. The turbine was mounted in front of a motorized barge as shown in Fig. 17, which was driven at a steady speed in still water. Test results showed that with diffuser the turbine power increased 3 times.

Edinburgh design ltd-united kingdom: Edinburgh University developed a variable pitch foil vertical axis tidal turbine. The turbine is a straight-blades vertical axis turbine designed for shallow channel. The model was created in Mat Lab (Edinburgh, 2006). The dimensions of the model are given in Table 9. For a stream speed of 2.3 m/s, the turbine rated 45 kW.

The support structure resembles catamaran boat, which slides in water without any external force while maintaining its stability under turbulent conditions. The hull structure is made of steel frames covered with steel

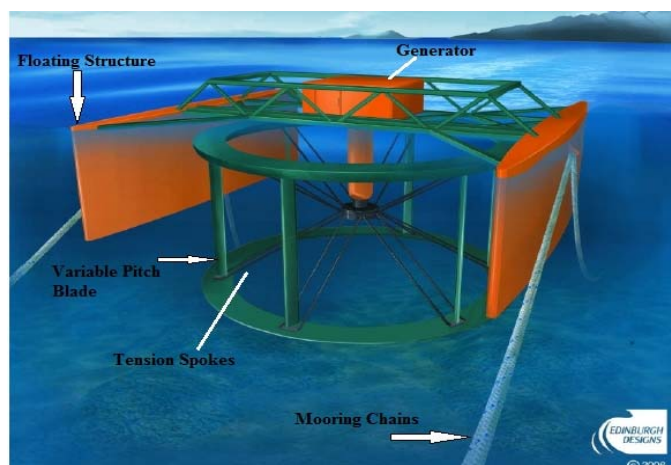

Fig. 18: Edinburgh turbine design

Table 10: Corporation and institutions engage in R and D

Company	Technology	Prototype tested	Country
Ocean university of china	College of engineering	Tested in 2008 (5 kW)	China
Edinburgh university	Polo	None	UK
GCK technology www.gcktechnology.com/GCK/	Gorlov turbine	Tested in Massachusetts	USA
Ing Arvid Nesheim www.anwsite.com/	Water turbine	None	Norway
Neptune RE. Ltdwww.neptunerenewableenergy.com	Proteus	None	UK
Ponte di Archimede www.pontediarchimede.it/language_us/	Kobold turbine	Strait of Messina, Sicily	Italy
Tidal energy Ltd. www.tidalenergy.net.au/?D=1	Davidson-hill venturi turbine	None	Australia
ITDG/IT (U.K) Fig. 19.	Garman turbine	River turbine (River Nile)	Sudan



Fig. 19: Garman turbine: ITDG, model

plates as shown in Fig. 18. Both static and dynamic analyses of the turbine are available and tested experimentally.

R & D on cross flow water turbine: List of marine tidal energy concepts and developers and the status of installation and environmental studies in 2008, this list highlight only vertical tidal turbine developers. Some of the negative effect of this technology on marine animal is also explained in this study (Technology Concepts and Developers, 2008), i.e., Noise in the Aquatic Environment and Its Effects on Aquatic Animals, Electromagnetic Fields in the Aquatic Environment and their Effects on Aquatic Animals etc. Table 10 shows main technology concepts and developers working on CFWT.

DISCUSSION AND CONCLUSION

Tidal stream power is an easy assessable and predictable form of energy in comparison to other emerging RE field like wind, biomass, solar and wave. Also this form of RE is less harmful to the environment as little or no siltation, less noise emission and produces no green house gases or any solid waste. The immense emission of carbon and other harmful gases due to burning of fossil fuels are one of the main agents of

global warming, so environmentalist, scientist and researchers are in great favor of this verdant source of energy.

The purpose of this study is to apprise oneself and to gather up to date about VATT for reviewers in one paper, also the author is working on straight bladed variable pitch vertical axis tidal turbine as a PhD candidate at Harbin Engineering University (China). From study it can be concluded that VATT has a simple structure with straight blades, so that it has no directionality issue when tidal flow change its direction diurnally, but the design and hydrodynamic prediction of this type need complex engineering and expertise in the field of fluid structure interaction Paraschivoiu (2002). For low head & shallow depth VATT is a better option. As VATT is more sensitive to cavitation, because it's working principle is based on lift type design. So, incorporating proper blade airfoil theory and CFD techniques plays an important role to mitigate cavitation and hence erosion, noise effects.

ACKNOWLEDGMENT

This research is financially supported by National S & T Programme (grants 2008BAA15B04, 2008C14039), Special Foundation for Ocean RE (grants ZJME2010GCO1, ZJME2010CY01) and '111'Project foundation from State Administration of Foreign Experts Affairs of China and MOE of China (grant B07019).

REFERENCES

- Achard, J.L. and T. Maître, 2004. Hydraulic Turbomachine. Patent Pending, Code FR 04 50209, Titulaire: Institut National Polytechnique de Grenoble, France.
- Anderson, J., 2002. Modern Compressible Flow. McGraw-Hill Science/Engineering/Math, College Park, pp: 776, ISBN-10: 0072424435.

- Antheaume, S., T. Maitre and J. Luc Achard, 2008. Hydraulic Darrieus turbines efficiency for free fluid flow conditions versus power farms conditions. *Renewable Energ.*, 33(10): 2186-98.
- Bahaj, A.S., A.F. Molland, J.R. Chaplin and W.M.J. Batten, 2007. Power and thrust measurement of marine turbines under various hydrodynamic flow conditions in cavitations tunnel and a towing tank. *J. Renew. Energ.*, 32(3): 407-426.
- Bachmann, R., 2011. Tidal Current Energy in Backstairs Passage. Retrieved from: <http://www.unisa.edu.au/sec/PG/students/TidalCurrentEnergy.pdf>, (Accessed on: January 17, 2011).
- Batten, W.M.J., A.S. Bahaj, A.F. Moll and J.R. Chaplin, 2008. The prediction of the hydrodynamic performance of marine current turbines. *J. Renew. Energ.*, 33(5): 1085-1096.
- Bernad, S.I., A. Georgescu, S. Georgescu and R.F. Resiga, 2008. Numerical investigations of the unsteady flow in the Achard Turbine. Proceeding of 6th IASME/WSEAS International Conference on Fluid Mechanics and Aerodynamics, Rhodes, Greece, pp: 59-65.
- Burton, T., D. Sharpe, N. Jenkins and E. Bossanyi, 2001. *Wind Energy Handbook*. John Wiley and Sons Ltd., UK, pp: 51-137.
- Camporeale, M.S. and V. Magi, 2000. Stream tube model for analysis of vertical axis variable pitch turbine for marine currents energy conversion. *J. Energ. Conver. Manage.*, 41(16): 1811-1827.
- Coiro, D.P., F. Nicolosi, A. De Marco, S. Melone and F. Montella, 2005. Dynamic behavior of novel vertical axis Tidal current turbine: Numerical and experimental investigations. Proceeding of 15th Internet Offshore and Polar Engin. Conference Seoul, Korea, Jun 19-24, Vol. 1.
- Consul, C.A., R.H.J. Willden, E. Ferrer and M.D. McCulloch, 2009. Influence of Solidity on the Performance of a Cross-Flow Turbine. Retrieved from: <http://www-civil.eng.ox.ac.uk/research/tidal/EWTEC2009-CFD-paper.pdf>, (Accessed on: January 17, 2011).
- Dai, Y.M. and W. Lam, 2009. Numerical study of straight bladed Darrieus type tidal turbine. *ICE-Energy*, 162(2): 67-76.
- Darrieus, G.J.M., 1931. Turbine having its rotating shaft transverse to the flow of the current. US Patent no. US 1.835.018, 1931.
- David, C., 2009. Prediction of the performance of a contra-rotating tidal turbine. M.Sc. Thesis, Department of Mechanical Engineering, University of Strathclyde Engineering.
- Edinburgh, D., 2006. Variable pitch foil vertical axis tidal turbine. Final Report, Edinburgh Design Ltd., Project T/06/00234/00/00.
- Faltinsen, O.M., 1990. *Sea Loads on Ships and Offshore Structures*. Cambridge University Press, Norwegian Institute of Technology, pp: 10-11.
- Georgescu, A.M., S.C. Georgescu, C.I. Cosoiu., N. Alboiu and A. Hamzu, 2010. Velocity Field in the Wake of a Hydropower Farm Equipped with Achard turbines. IOP Conf: Earth Environ. Sci., 12 012108, Retrieved from: <http://iopscience.iop.org/1755-1315/12/1/012108>, (Accessed on: November 09, 2010).
- Gorlov, A.M., 1997. Helical turbine assembly operable under multidirectional fluid flow for power and propulsions systems. US Patent no: US 5.451.137.
- Gorlov, A., 1998. Development of the helical reaction hydraulic turbine. Final report DE-FGO1-96EE 15669.
- Gorlov, A.M., 2001. Tidal Energy 5 Big Dams Barra. Northeastern University, Boston Massachusetts, Academic Press, USA, DOI: 10.1006/rwos.2001.0032.
- Grabbe, M., 2008. Marine current energy conversion. Thesis, Uppsala University, pp: 25-26.
- Hardesty, J., 2009. *The Analysis of Tidal Stream Power*. John Wiley and Sons, Ltd., University of Hull, Kingston, UK, pp: 65.
- Hatch Energy Report, 2008. Retrieved from: <http://canmetenergy-canmetenergie.nrcan-rncan.gc.ca/fichier.php/codectec/Fr/H327842.201.01/Low+Head+Market+Assess+Rpt++Vol%5E1+Main+Report.pdf>. (Accessed on: January 01, 2011)
- Hwang, I.S., H.Y. Lee and S.J. Kim, 2009. Optimization of cycloidal water turbine and the performance improvement by individual blade control. *J. Appl. Energ.*, 86(9): 1532-1540.
- Journee, J.M.J. and W.W. Massie, 2001. *Offshore Hydrodynamics*. 1st Edn., Delft University of Technology, pp: 4-38.
- Justin, E.K., 2001. Hydrofoils and Propellers, Lecture Notes. Retrieved from: <http://www.ocw.mit.edu/courses/mechanical-engineering>.
- Khan, M.J., M.T. Iqbal and J.E. Quaicoe, 2008. Tow Tank Testing and Performance Evaluation of a Permanent Magnet Generator Based Small Vertical Axis Hydrokinetic Turbine. In: North American Power Symposium (NAPS), Calgary, Canada, pp: 1-7.
- Kiho, S., M. Shiono and K. Suzuki, 1996. The power generation from tidal currents by Darrieus turbine. *J. Renew. Energ.*, 9(1-4): 1242-1245.

- Lain, S. and C. Osorio, 2010. Simulation and evaluation of a straight-bladed Darrieus-type cross flow marine turbine. *J. Scientific Indus. Res.*, 69(12): 906-912.
- Li, Y., Sander and M. Calisal, 2007. Preliminary result of a vortex method for individual marine current turbine. Accepted by 26th International Conference of Offshore Mechanics and Arctic Engineering San Diego, CA, pp: 10-15.
- Li, Y., Sander and S.M. Calisal, 2007. Analysis of Turbine Hydrodynamic Interactions-A Preliminary investigation. Retrieved from: <http://www.ieeexplore.ieee.org/stamp/stamp.jsp?arnumber=04449328>.
- Li, Y. and S.M. Calisal, 2010. Three-dimensional effects and arm effects on modeling a vertical axis tidal current turbine. *J. Renewable Energ.*, 35(10): 2325-2334.
- Lubing, W., Z. Liang and Z. Niandong, 2004. An optimization method for improving hydrodynamic performance of the vertical-axis turbine for tidal streams energy conversion. *J. Harbin Eng. Univ.*, 25(4): 417-422.
- McCamy, R.C. and R.A. Fuchs, 1954. Wave forces on piles, B.E.B. Tech. Memo., No. 69.
- Molland, A.F., A.S. Bahaj, J.R. Chaplin and W.M.J. Batten, 2004. Measurements and predictions of forces, pressures and cavitation on 2-D sections suitable for marine current turbines. *Proc. Inst. Mech. Eng, Part M: J. Eng. Mar. Environ.*, 218(2): 127-138.
- Newman, J.N., 1935. *Marine Hydrodynamics*. The MIT Press Cambridge, Massachusetts and London, England, pp: 191-227.
- Nguyen, T., 2008. Tidal Power: Alternative source of energy. COSMOS 2008 UCD.
- Orme, J.A.C. and I. Masters, 2010. Analysis and Comparison of Support Structure Concepts for Tidal Stream Turbines. Retrieved from: <http://www.en4.swan.ac.uk/egmastersi/images/supportstructures/pdf>, (Accessed on: November 13, 2010).
- Osa Amilibia, J.L. and I. Aio, 2010. Selection of the Electrical Generator for a Wave Energy Converter. International Conference on Renewable Energies and Power Quality (ICRE PQ'10) Granada (Spain), 23rd to 25th March.
- Paraschivoiu, I., 2002. *Wind Turbine Design with Emphasis on Darrieus Concept*. Polytechnic International Press, UK, pp: 377-381.
- Ponta, L.F. and M.P. Jacovkis, 2001. A vortex model for Darrieus turbine using finite element techniques. *J. Renewable Energ.*, 24(1): 1-18.
- Razak, J.A., Y. Ali, M.A. Alghoul, M.S. Zainol, A. Zaharim, *et al.*, 2010. Application of cross flow turbine in off-grid pico hydro renewable energy system. Proceedings of the 2010 American Conference on Applied Mathematics, AMERICAN-MATH'10, pp: 519-526.
- Rourke, F., F. Boyle and A. Reynolds, 2010a. Marine current energy devices: Current status and possible future applications in Ireland. *J. Renew Sustain Energy Rev.*, 14(3): 1026-1036.
- Rourke, F., F. Boyle and A. Reynolds, 2010b. Tidal energy updates 2009. *J. Appl. Energ.*, 87(2): 398-409.
- Salter, S.H., 1998. Proposal for a large, vertical-axis tidal-stream generator with ring-cam hydraulics. Third European Wave Energy Conference, 30th Sept-2nd to Oct, Patras Greece.
- Salvatore, F., L. Greco and G. Calcagno, 2010. A Theoretical and Computational Methodology to Study Vertical-Axis Turbines Hydrodynamics. Retrieved from: (<http://192.107.92.31/test/owemes/34.pdf>), (Accessed on: 10.11.2010).
- SOPAC, 2001. Ocean thermal energy conversion & the pacific islands. Report No. 417.
- Sustainable Energy Ireland (Report). Retrieved from: <http://www.seai.ie/Publications/Renewables-Publications/Tidal-Current-Energy-Resources-in-Ireland-Report.pdf>.
- Technology Concepts and Developers, 2008. Appendix: B. Retrieved from: http://www.ornl.gov/sci/eere/EISARepo/pdfs/EISA_Report_Appendices.pdf.
- U.S. Energy Information Administration, 2010. International Energy Outlook-Highlights. Report No: DOE/EIA-0484(2010).
- Van Dyke, M., 1975. *Perturbation Methods in Fluid Mechanics*. 15th Edn. Parabolic Press, Stanford.
- Wang, D., M. Atlar and R. Sampson, 2007a. An experimental investigation on cavitation, noise and slipstream characteristics of ocean stream turbines. *Proceeding of International Meche A J. Pow. Energ.*, 221(2): 219-231.
- Wang, L.B., L. Zhang and N.D. Zeng, 2007b. A potential flow 2-D vortex panel model: Applications to vertical axis straight blade tidal turbine. *J. Energ. Conver. Manage.*, 48(2): 454-461.
- White, F.M., 1982. *Fluid Mechanics*. Parabolic Press, Stanford, CA, pp: 427-445.
- Zanette, J., D. Imbault and A. Tourabi, 2010. A design methodology for cross flow water turbines. *J. Renew. Energ.*, 35(5): 997-1009.