

# Truchet Tilings Revisited

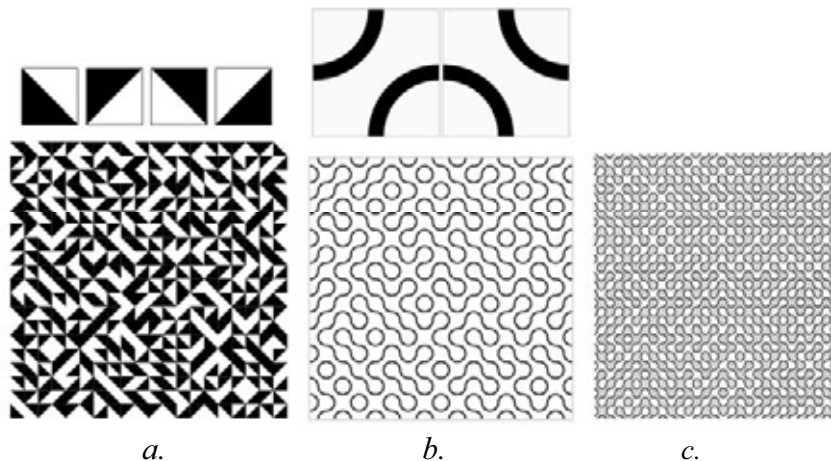
Robert J. Krawczyk  
College of Architecture  
Illinois Institute of Technology  
3360 South State Street,  
Chicago, IL, 60616, USA  
E-mail: krawczyk@iit.edu

## Abstract

Repeating patterns in architecture are utilized in elements at a variety of scales; scale of a facade, perforated ceilings, and wall reliefs to carpeting and tile stonework. The Truchet tiling concept can now be reconsidered as one means to develop a modular non-repeating pattern. This paper explores some of the basic concepts of Truchet tilings and variations developed; and some current examples of using these methods with digital generation and fabrication methods.

## Background

A number of formal repeating pattern concepts and system exist for designers and architects to utilize. They may as simple as uniform tilings and patterns, frieze and wallpaper groups, or complex as systems that can use randomness for placing individual patterns. Grunnbaum and Shephard offer a comprehensive and systematic treatment of the subject [1]. With the greater introduction of digitally based generative systems, algorithmically generated patterns, and greater means of digitally controlled fabrication, the concept of many-of-one is becoming one-of-many. As real-time steaming fabrication evolves, the need for non-repeating patterns will be easier to satisfy.



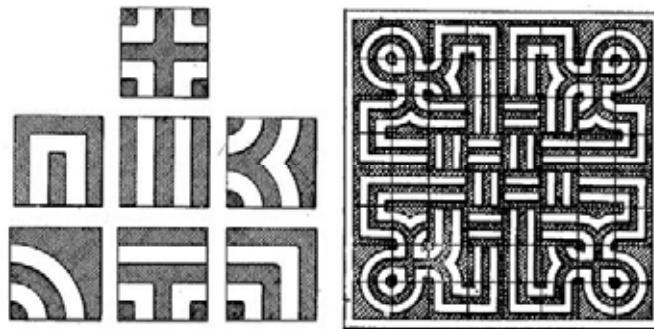
**Figure 1:** *Truchet pattern, Smith variation, Smith shading.*

One such patterning concept which can be revisited is the modular shape combinations first observed and developed by Father Sebastien Truchet. Father Truchet (1657-1729) was of the French clergyman living in Lyon. He is known for being active in areas of mathematics, hydraulics, graphics, and typography. An

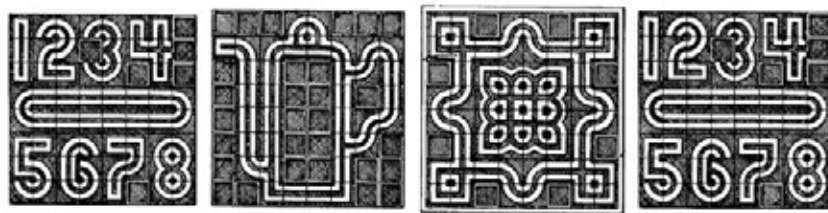
excellent repository of links to Truchet's writings and plates can be found on Jacques Andre's website [2]. Figure 1a displays one of the many periodic patterns he developed. In 1704 he published "Memoir sur les combinaisons" in which a number of plates were developed to show periodic patterns. In 1722, P. Dominique Douat further elaborates on Truchet tilings [4]. Lord & S Ranganathan cover both Truchet and Douat's patterns [5]. The Andre website also includes the writings of Douat [2].

One of the basic concepts that one can see of Truchet tilings is that adjacent tiles can create much larger contiguous edge connecting patterns. In 1987 Cyril Smith analyzed the structure of Truchet's tilings and first abstracted them into simple diagonal lines and then into two arcs starting and ending at edge midpoints, Figure 1b [6]. Smith wrote about the closures that were being formed, circles; and also showed an example that was color filled to further highlight these positive and negative, concave and convex patterns, Figure 1c.

In 1977, Martin Gardner wrote about non-periodic tilings on darts and kites that included arcs connecting midpoint edges [7]. Later, 1989 and 1990 Clifford Pickover also wrote about arc tiles used the generation of random tiling patterns [7][8]. C. Browne further investigated the shading of the Truchet tilings by including examples using triangular and hexagonal tiles [10][11].

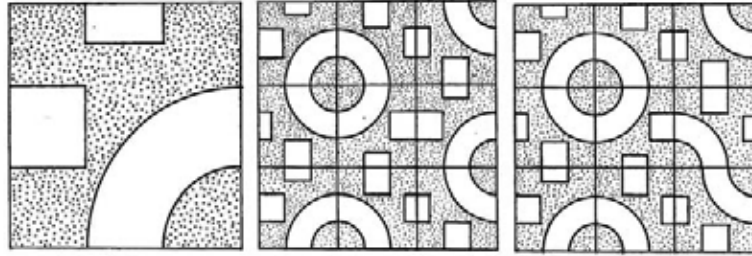


**Figure 2:** *Toy Designing Blocks by Graham, 1934.*



**Figure 3:** *Examples of Graham's Toy Designing Blocks.*

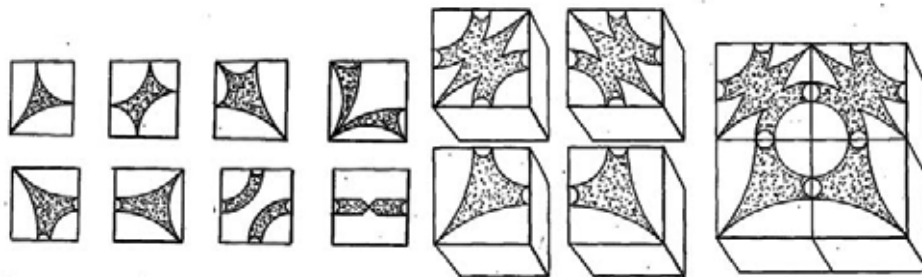
Following non-academic research and writing, we find that in 1934, a patent for a Toy Designing Block was granted to Tom C. Graham, 1,973,564, Figure 2 and 3 [12] This patent expired and 1991 patent 5,011,411 was granted to a Method of Making a Non-Repetitive Modular Design to Andreas F. Loewy, Figure 4 [13]. It expired in 2003 for nonpayment of maintenance fees. Researching previous art of these patents also uncovered US Patent 1,453,728 Means for Devising Ornamental Designs granted in 1923 to F. J. Rhodes, Figure 5 [14]. It has at least of the modular patterns that appear later, the two arcs at the midpoints.



**Figure 4:** *Examples of Loewy modular design.*

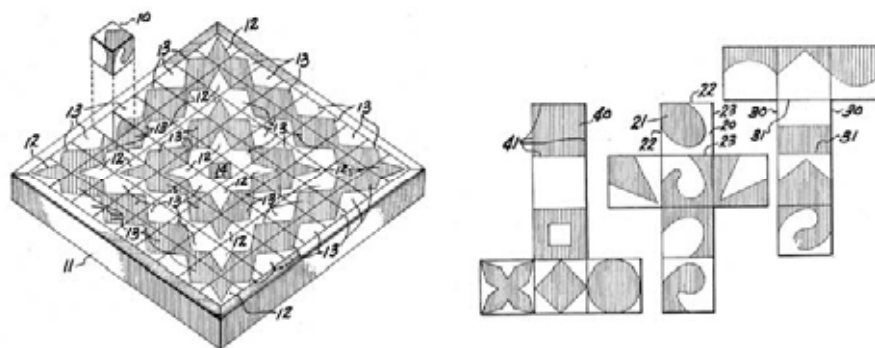
As demonstrated by Loewy, the concept of how the adjoining edges could extend to a larger design was well understood, as seen here in his description:

“Each module is made in the following manner. Assume that the regular polygon has  $n$  sides. First, one chooses a set of points on one of the sides of the polygon, the points being distributed symmetrically around the midpoint of the side. Then, one duplicates this arrangement of points on each of the remaining sides. Next, one connects pairs of points with lines, such that every point is connected to one line. The lines can be straight or curved, but they must be continuous. The lines are drawn such that the resulting pattern is not symmetrical around any imaginary straight line joining any pair of vertices of the polygon. Finally, one can optionally fill in some or all of the spaces defined by pairs of lines, or by one or more lines and one or more sides of the polygon, with color or with some other design element.” [13]

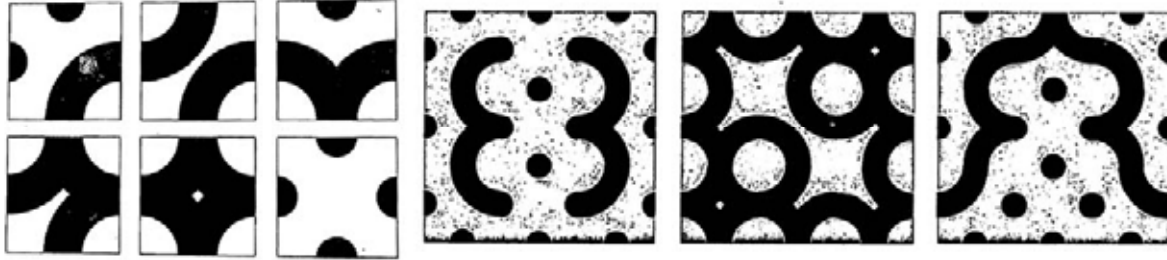


**Figure 5:** *Examples of Rhodes ornamental design, 1923.*

More recently, US Patent 3,464,145 Set of Blocks for Generating Designs was granted to P. C. Martin in 1969, Figure 6 [15] and US Patent application 10/792,627, System of Combinable Patterns that Generates Artful Designs submitted in 2004 by Pablo Fernando Cha included many of the same concepts as others before him, Figure 7 [16]. This application was abandoned in 2008.



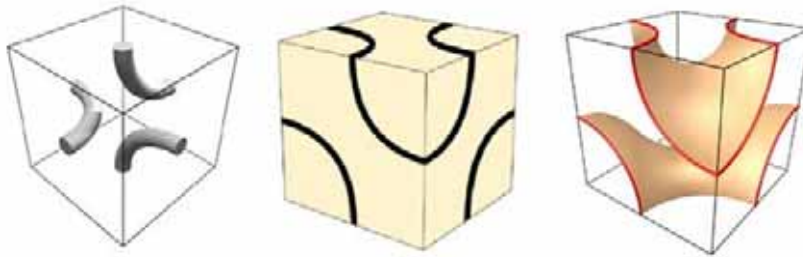
**Figure 6:** *Examples of Martin blocks, 1969.*



**Figure 7:** Examples of Cha ornamental design, 2004.

It should be noted that none of the patent descriptions ever mentioned the work of Truchet, Smith, or any others noted here; and also none of the writings of Smith and others ever mention the work being applied and granted for patents.

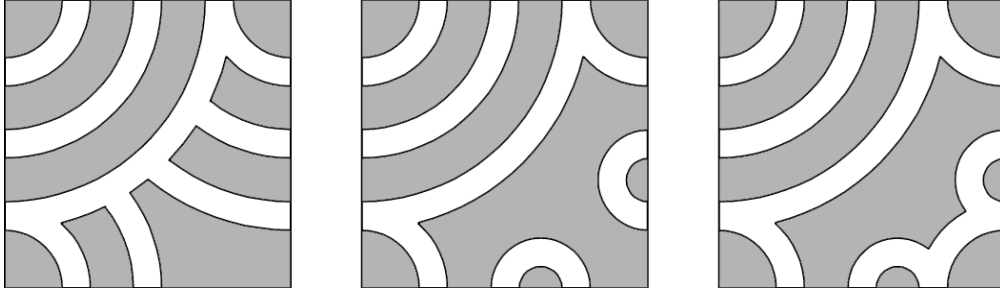
The Truchet tilings have also appeared in three-dimensions, Figure 6 as in Browne [10]. Browne also includes a diagram that has the tiling on the face of a cube; it is a diagram for the resulting surface model. Browne also extends these three-dimensional models with the use of spheres.



**Figure 8:** Examples of three dimensional Truchet-like modules.

### **Developing Truchet-like Tilings**

The initial interpretation of the underlying concept of Truchet tilings was the connection of the midpoints of adjacent edges. We have seen in the patent search that others have also developed tiles using two and three equal subdivisions of edges. We have also seen the edge points connected with arcs and with straight line segments or ribbons. To further explore this tiling concept, a number of versions were developed in 2005, with two and three edges points were developed. From that series a total of three tiles emerged. Figure 9 displays the first set of tiles developed. It these tiles symmetry is across the diagonal. The ribbon connector was used to develop a coloring density between the foreground and background. The initial tiles were fabricated with a laser cutter using two tones of wood, in this case, inexpensive 1/8" MDF, Medium Density Fiberboard. Referring to Figure 10, the backing, the bottom layer, was simply a 11 inch square of light toned MDF and the top layer consisted of a series of 1.25 inch ribbons of a darker toned MDF. The plan for these wooden tiles was to attach them to a wall surface in a manner that they could be reoriented individually on a regular basis. The full fabrication of this version was never realized.



**Figure 9:** *Initial tile patterns developed.*



**Figure 10:** *Laser cut tiles, using two tones of wood.*

These initial tiles were also replicated in a 20 inch square array, randomly rotating each tile as it was placed. Figure 11 displays a black and white version of these images, a color series of these were also developed and titled Paths [17]. The Path series explores using a single tile or randomly selecting one from two or more different tiles. Using multiple tiles in a single tiling offered a greater opportunity for variation.



**Figure 11:** *Image printed version of the random tilings.*

The Path series also mimics the concept Sol LeWitt developed in his Wall Drawings, in particularly #358, 1981, which consists of arcs drawn from opposite corners of a square grid pattern [18]. The Wall drawings consisted of drawn arcs or lines connecting opposite corners of a grid where his crew was instructed to determine the orientation of the arc or line as they executed each individual module. In this case, the software replaces the crew and an algorithm using a random function computes the rotation of the module, replacing the decision of the individual crew person. Each time a tiling pattern is pattern executed a unique piece is generated.

For an installation at the 2010 Art Loop Open, an interactive modular tiling piece was proposed and selected. A version of the tiles was developed as a four inch magnet. A set of steel sheets were placed in a six by three foot frame. A total of 128 magnets were placed on the surface and viewers were encouraged to pick up any one of them, rotate it, and place it back. Figure 12 displays a single magnet and some initial arrangements, and Figure 13 shows the complete installed piece onsite.

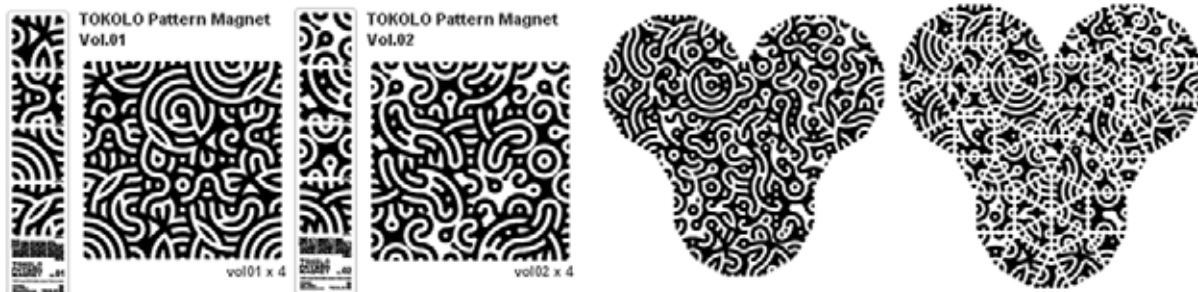


**Figure 12:** Printed magnet tiles, red ribbons on black background.



**Figure 13:** Installation at 2010 Art Loop Open in Chicago.

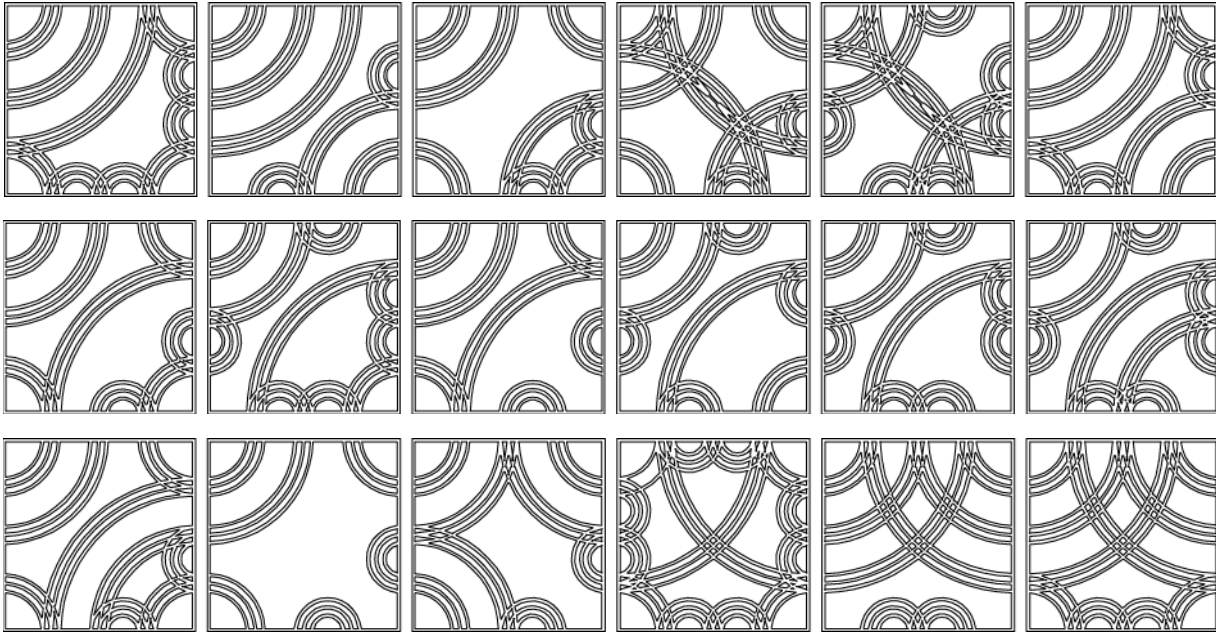
Research has also found similar tile designs, both as a square tile and a triangular tile configuration by Japanese architect and designer Asao Tokolo, shown in Figure 14 [19]. His website does not cover the design development of these tiles nor how they originated. His designs consist of five edge points and are more free-form in the ribbon shapes included.



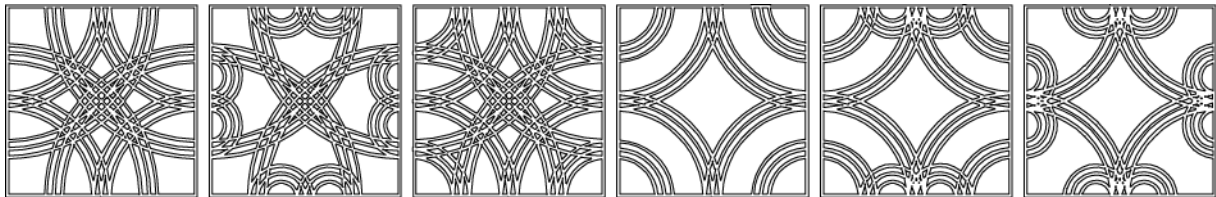
**Figure 14:** Magnet designs by Asao Tokol

The wall piece led to an interest in developing a larger, more variable piece that could also be interactive but possibly more three-dimensional. This led to developing a series of tile designs that could be placed on

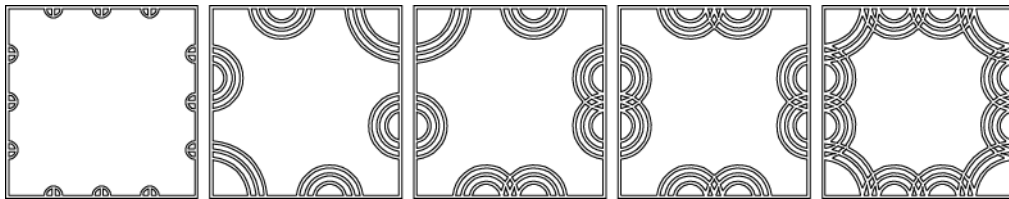
the surfaces of a cube. The solid ribbons that were in the print and magnet tiles were recreated as three much thinner ribbons. The intersection of the multiple banded ribbons forms a very interesting blending and when laser cut and assembled into a cube, give the cube a very light and lacy appearance.



**Figure 15:** *Tile designs for cube surfaces, diagonal symmetry.*



**Figure 16:** *Tile designs for cube surfaces, horizontal and vertical symmetry.*



**Figure 17:** *Tile designs for cube surfaces, terminators.*

Figures 15, 16, and 17 display some of the designs that were developed. All display some symmetry and all consist of simple arcs connecting any the three edge points. The last set includes a series of terminators for the ribbons. These will in a future study be filled in with color and generated as prints using a random selection individual modules and random orientation.



**Figure 18:** *Laser cut cubes.*

Figure 18 displays the final assembled laser cut six inch cubes. An overlapping edge was developed so the cubes could be easily assembled. The most similar item currently on the market is a block game titled Motif Cubes Wooden Block Game, designed by newartifacts, a group of artists and designers from Uruguay, South America. These consist of nine 1 3/8 inch painted cubes, Figure 19. Browne also has developed a series of games that are based on Truchet-like tilings of all different shapes, three-dimensional and two-dimensional [20].



**Figure 19:** *Motif Cubes.*

These studies begin to demonstrate some of the possibilities of using a modular design element with random selection and random orientation to generate repeating patterns that would most likely not actually repeat. With the utilization of a digitally driven fabrication system, each piece manufactured could be a unique combination of basic elements. In some emerging technologies, such as, large scale carpet printers, if the design were to be streamed horizontal row by row, a very large area could be manufactured without any repetition. Otherwise, less technical demanding tiling systems such as carpet, wall, and ceiling tiles and panels could be economically manufactured while still offering a very great variety of unique installations.

## References

- [1] B Grünbaum and G C Shephard, *Tilings and Patterns*, W H Freeman, 1987.
- [2] J. Andre, Website for S. Truchet, <http://jacques-andre.fr/faqtypo/truchet/>
- [3] S. Truchet, *Memoir sur les combinaisons*, *Memoires de l.Academie Royale des Sciences*, pp.363-72, 1704.



- [4] P. Dominique Douat , Methode pour faire une infinite de desseins differents avec des carreaux mipartis de deux couleurs par une ligne diagonale: ou observations du Pere Dominique Douat Religieux Carme de la Province de Toulouse sur un memoire insere dans l'Histoire de l'Academie Royale des Sciences de Paris l'annee 1704, presente par le Reverend Pere Sebastastien Truchet religieux du meme ordre, Academicien honoraire, Paris, 1722.
- [5] E A Lord & S Ranganathan. Truchet tilings and their generalisations. Resonance 11 (2006) 42-50.
- [6] C S Smith, The tiling patterns of Sebastien Truchet and the topology of structural hierarchy, Leonardo, Vol.20, pp.373-385, 1987.
- [7] M. Gardner, "Extraordinary Non-Periodic Tilings That Enrich the Understanding of Tiles", Scientific American 236, No. 1, 110-121 (1977).
- [8] C. A. Pickover, "Picturing Randomness with Truchet Tiles." J. Recr. Math. 21, 256-259, 1989.
- [9] Pickover C. Picturing randomness with Truchet tiles. Computers, pattern, chaos, and beauty: graphics from an unseen world. New York: St Martin's Press; 1990. p. 329-32.
- [10] C. Browne, "Truchet curves and surfaces," Computers & Graphics, 32:2, 2007, 268-281.
- [11] C. Browne, "Duotone Truchet-like Tilings," Mathematics and the Arts, 2:4, December 2008, 189-196.
- [12] T. C. Graham, Toy Designing Block, US Patent 1,973,564, 1934.
- [13] A. F. Loewy , Method of Making a Non-Repetitive Modular Design, US Patent 5,011,411, 1991.
- [14] F. J. Rhodes. Means for Devising Ornamental Designs, US Patent 1,4,53,728, 1923.
- [15] P. C. Martin, Set of Blocks for Generating Designs, US Patent 3,464,145, 1969.
- [16] P. F. Cha, System of Combinable Patterns that Generates Artful Designs in US Patent application 10/792,627, 2004.
- [17] R. J. Krawczyk, Path Print Series, [bitartworks.com](http://bitartworks.com)
- [18] G. Garrels, Editor, Sol LeWitt: A Retrospective, Yale University Press, 195, 2000.
- [19] A. Tokolo, [tokolo.com](http://tokolo.com)
- [20] C. Browne, [www.cameronius.com/games/](http://www.cameronius.com/games/)