

**Everything You Always Wanted to Know about the IRI,  
But Were Afraid to Ask!**

by

Thomas D. Gillespie, Ph. D.  
The University of Michigan Transportation Research Institute

Presented at the  
Road Profile Users Group Meeting  
September 22-24, 1992  
Lincoln, Nebraska

# Everything You Always Wanted to Know about the IRI, But Were Afraid to Ask!

by

Thomas D. Gillespie, Ph. D.

The University of Michigan Transportation Research Institute

## Abstract

The International Roughness Index has become the standard scale on which road roughness information is reported both here in the United States [1]\* and in many countries of the world. Procedures for determining the IRI are well developed and reliable, yet many users are unaware of the history of its development and the physical significance of this measure of roughness. This paper describes the history of roughness measurement from which the IRI evolved, and explains the physical meaning of the index.

## Roughness Measurement in the Past

“Ever since roads and highways have been constructed, the people who use them have been keenly aware of the relative degrees of comfort or discomfort experienced in traveling” [2]. The evidence that remains today from the paved roads of the Roman Empire (see Fig. 1) suggests that roughness must have been a concern for chariot travel. Even in the 1800s, high-speed travel in this country by stage coach had a reputation for rigor directly resulting from roughness of the roadway.

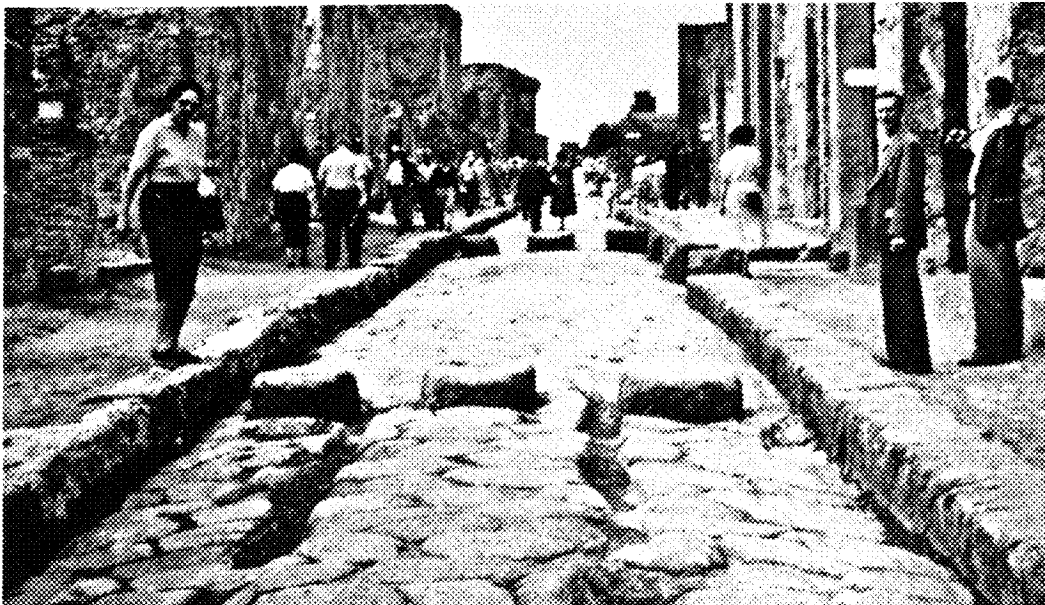

Fig. 1 Photograph of an early Roman road [2]

---

\* Numbers in brackets refer to references at end.

With the introduction of the gasoline-powered motor vehicle at the turn of the Twentieth Century, more people had access to means of high-speed personal travel and the travel speeds rapidly surpassed the limits practical with horses. The increase in speed placed even greater premium on building and maintaining roads with a smooth travel surface.

Those early years saw the first rudimentary attempts to measure the roughness properties of a road. A sliding straightedge, known as the “Viagraph,” (see Fig. 2) was one of the first methods to measure roughness by recording the deviation at the center point of the straightedge [2]. The measurement response of the straightedge is indicated by the gain shown in the figure. Long wavelengths (low wavenumbers) produced no response, whereas the gain approached unity at wavelengths equal to or less than the base length of the straightedge. Interestingly enough, the roughness measured by this device was reported in feet of deviation per mile, with 15 feet/mile (180 inches/mile) recommended as the standard for construction.

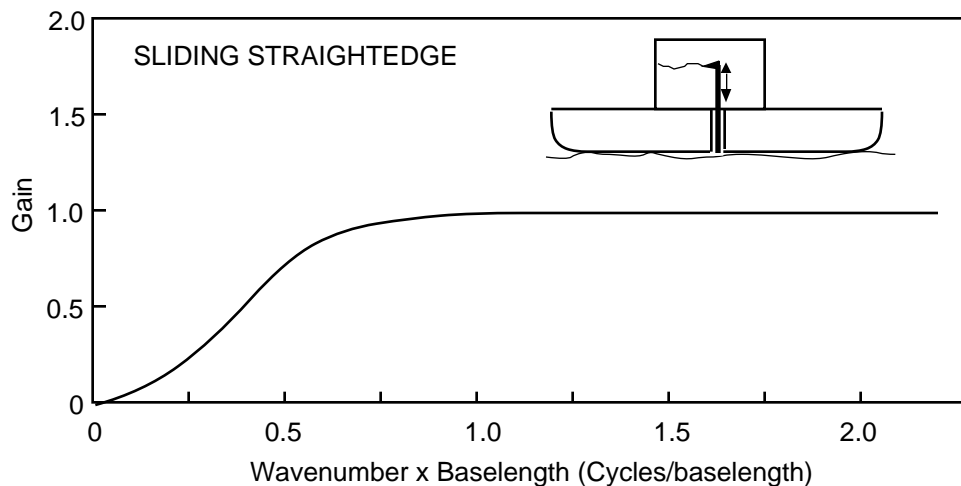

Fig. 2 Response of the sliding straightedge road roughness measuring device

With the obvious disadvantages of the effort to move the sliding straightedge and the wear and tear that resulted, it was not surprising to see development of the rolling straightedge (see Fig. 3). This device had its own unique response to roughness that was different from the sliding straightedge, characterized by the fact that it recorded every bump three times—once when the front wheel passed over, a second time when the measuring wheel passed over, and a third time when the rear wheel passed over. Because the straightedge contacted the road surface at three points, bumps of certain wavelengths recorded at twice amplitude, while others did not record at all. Thus the rolling straightedge "tuned" to certain wavelengths of roughness in the road, while ignoring others.

To overcome this problem the rolling concept was subsequently improved by adding an array of wheels to establish a reference plane from which to measure deviations (see Fig. 4), and remains with us today memorialized as the Profilograph. Bogey attachments for the array of wheels averaged the elevation of all points under the wheels, and roughness was measured as deviation of the center wheel from this reference. With a large number of wheels the response approaches the theoretical limit shown in the figure.

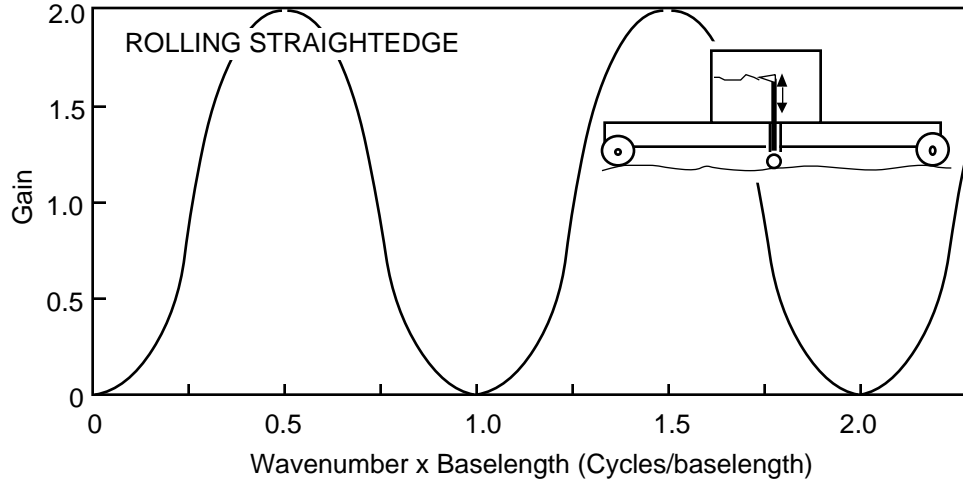

Fig. 3 Response of the rolling straightedge road roughness measuring device

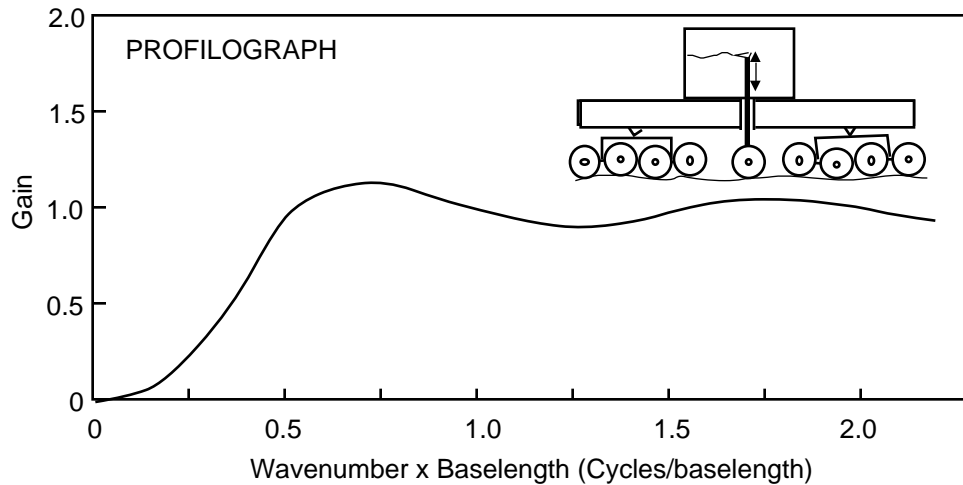

Fig. 4 Response of the Profilograph

With the variation in response properties for each of these measurement devices, it is clear that progress was not being made toward consensus on a universal and standardized measure of road roughness.

By the 1920s highway engineers recognized that roughness properties in a road of greatest importance were those responsible for causing vibrations of motor vehicles. The “Via-Log” developed by the State of New York evidenced this thinking by measuring the suspension travel of a passenger car as an indication of the roughness level. The first devices recorded the suspension motion, but were soon modified to sum the motion on a mechanical counter and measure an “inches/mile” statistic.

Over the next decades the difficulty of obtaining consistent measurements by this method, due to the variations in dynamics of motor vehicles, led to the attempt to “standardize” the vehicle. The Bureau of Public Roads (BPR) Roughometer (later adapted in similar form as the Bump Integrator by the Transport and Road Research Laboratory in

England) was born in 1941. The Roughometer was a single-wheel trailer (see Fig. 5) in which all dimensions, mass properties, and tire and suspensions properties were standardized in an effort to achieve comparable performance on all devices.

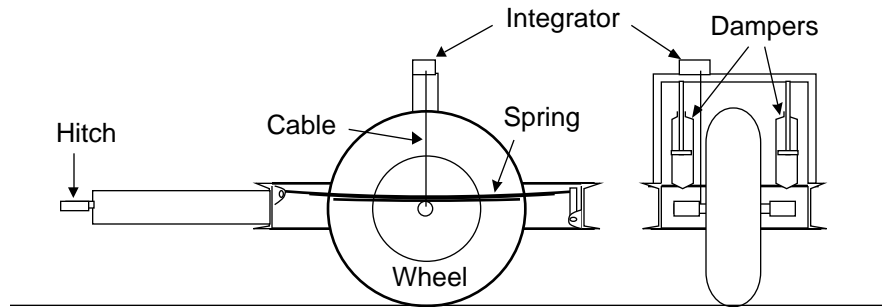

Fig. 5 The BPR Roughometer

One other important roughness measurement device developed at the time of the AASHO Road Test [3] was the CHLOE (an acronym formed from the first letters of the inventors' names). The CHLOE (see Fig. 6) consisted of a trailer towed at a low speed on which was mounted two small wheels 9 inches apart with instrumentation to measure and record the local road slope. The signal recorded was the slope deviation (or slope variance), which is generically an "inches/mile" statistic. The slope variance measured by the CHLOE is of particular significance to highway engineers today as it was the historical reference for roughness used in development of the Pavement Serviceability concept [4]. Despite this special status, the CHLOE is no longer in routine use today.

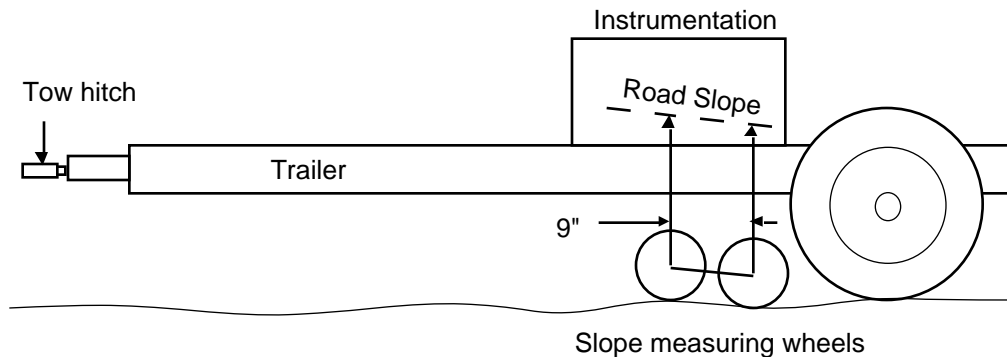

Fig. 6 Illustration of the CHLOE

By the 1960s the attraction of being able to measure roughness properties from a moving vehicle motivated development of "roadmeters" (sometimes called "ridemeters") in the form of the Mays Meter [5], the PCA Meter [6], and other comparable devices. The relatively inexpensive devices could be mounted in any available automobile as shown in Figure 7, and would measure the axle displacement as the vehicle traversed a test section. Most of the roadmeters measured accumulated axle displacement, which is the "inches/mile" deviation of the road surface colored by the dynamics of the vehicle. (The PCA Meter differed in that it would give greater weight to large displacements, but could also be used to simply accumulate displacements like the other meters.) This general class of devices became known as Response-Type Road Roughness Measurement Systems (RTRRMS).

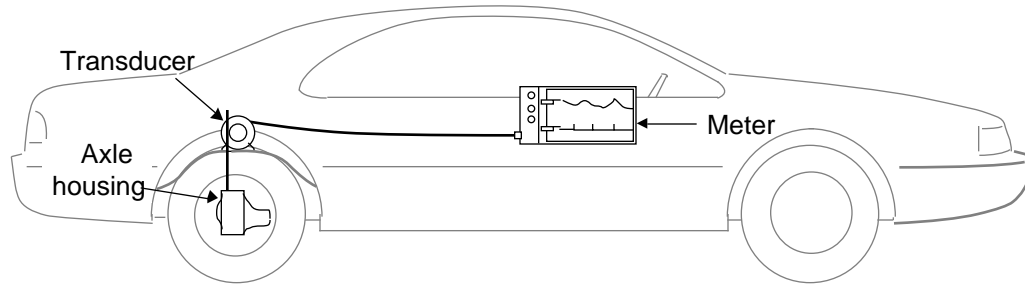

Fig. 7 Illustration of an RTRRMS

Because of their simplicity and low cost, RTRRMS were acquired by the highway departments of approximately half of the states by the late 1970s. Although they reliably measured high “inches/mile” on bad roads and lower numbers on smooth roads, they were not accurate enough for most engineering applications. As might be expected, no two roadmeters gave identical measurements because of differences in the dynamics of the vehicles, and consistent performance from day-to-day with individual roadmeters was also difficult to achieve. Such routine actions as adding fuel or passengers, adjusting tire pressure, balancing tires, etc. changed the "calibration" of the device. As a result it was difficult to develop and maintain a database of road roughness conditions without extensive effort at controlling or compensating for vehicle changes by frequent calibration exercises.

This problem was addressed by the National Cooperative Highway Research Program in 1978 in the Project 1-18 [7], "Calibration and Correlation of Response-Type Road Roughness Measuring Systems," which began the work eventually leading to development of the International Roughness Index (IRI).

The NCHRP project examined the sources of variability in roughness measurement with RTRRMS and identified calibration procedures to compensate for each so that measurements would be consistent and correlatable between different systems. Concurrently, the World Bank faced a similar though broader problem of obtaining comparable measurements of roughness (for data input to highway cost models) in the many countries in which it was providing loans for development of road systems. Although RTRRMs were used in many of these countries, to achieve consistent measurement performance rigorous calibration methods were needed that could be based on technology available at these sites. Equally important was the need for a standard scale of roughness that would be stable over time and transportable throughout the world to allow comparison of measurements on a worldwide basis. To address this problem the International Road Roughness Experiment was organized and conducted in Brazil in 1982 [8].

The outcome of these efforts was the identification of a standard scale now known as the International Roughness Index (IRI). Many factors were considered in its selection:

- The index had to be related to the vibration response of motor vehicles, as most roughness indices were either directly or indirectly linked to motor vehicle performance
- The scale had to be mathematically related to road profile in order to be stable with time (as all attempts to standardize hardware had been unsuccessful)

- It had to be measurable by a widest possible range of hardware (i.e., rod and level, RTRRMS, profilometers, etc.)
- It had to be transportable (i.e., procedures and hardware requirements had to be defined so that it could be reliably reproduced throughout the world).

### **The Rationale behind the IRI**

The International Roughness Index (IRI) is a scale for roughness based on the response of a generic motor vehicle to roughness of the road surface. Its true value is determined by obtaining a suitably accurate measurement of the profile of the road, processing it through an algorithm that simulates the way a reference vehicle would respond to the roughness inputs, and accumulating the suspension travel. Thus it mathematically duplicates a roadmeter.

In virtually all of the measuring systems described above the roughness is quantified by some measure of vertical deviations over a section of road. The cumulative deviations per mile (i.e., “inches/mile”) are a summary measure of road slope deviations. Nearly all roughness measurement systems—from the early straightedge devices, to the CHLOE of the AASHO Road Tests, to the roadmeters—measure a slope statistic. However they don’t obtain identical measurements because each device has unique sensitivities to different wavelengths in the road as illustrated in the previous figures. There is no such thing as a “true” measure of slope deviations, because over the full range of wavelengths the value is infinite. Finite values are obtained only by limiting the band of wavelengths over which measurements are made. This happens naturally with every measurement system because each has limits to its response, although the limits are often ill-defined and response is variable with wavelength.

In the case of roadmeters, the cumulative stroke of the automobile's suspension is measured over a section of road colored by the particular response characteristics of the automobile. This is what is done in computation of the IRI. The relevant response properties of an automobile are captured by a simple dynamic model known as the quarter-car model shown in Figure 8. At each wheel position the vehicle behaves as a sprung mass sitting on a suspension with stiffness and damping, which in turn is attached to the unsprung mass of the wheel, brake, and suspension components. The wheel contacts the road by a tire which acts like a spring. Road inputs to the car flex the tire, stroke the suspension, and cause the sprung and unsprung masses to vibrate in the vertical direction.

Whether the roughness is viewed as deviations in elevation (displacement inputs), slope (velocity inputs), or change of slope (acceleration inputs) the quarter car responds in a defined manner. The response can be mathematically described with a relatively simple set of dynamic equations known as a quarter-car simulation. At very low frequencies (corresponding to long wavelengths in the road) the suspension response is zero because the wheel and the vehicle body move up and down together. Road inputs at frequencies near one Hertz cause the sprung mass to resonate on the suspension producing stroke that is slightly greater than the road input. The response is maintained up through frequencies near 10 Hertz where axle resonance occurs. Above the axle resonant frequency the response again drops to zero as the road bumps simply deflect the tire without producing significant suspension stroke.

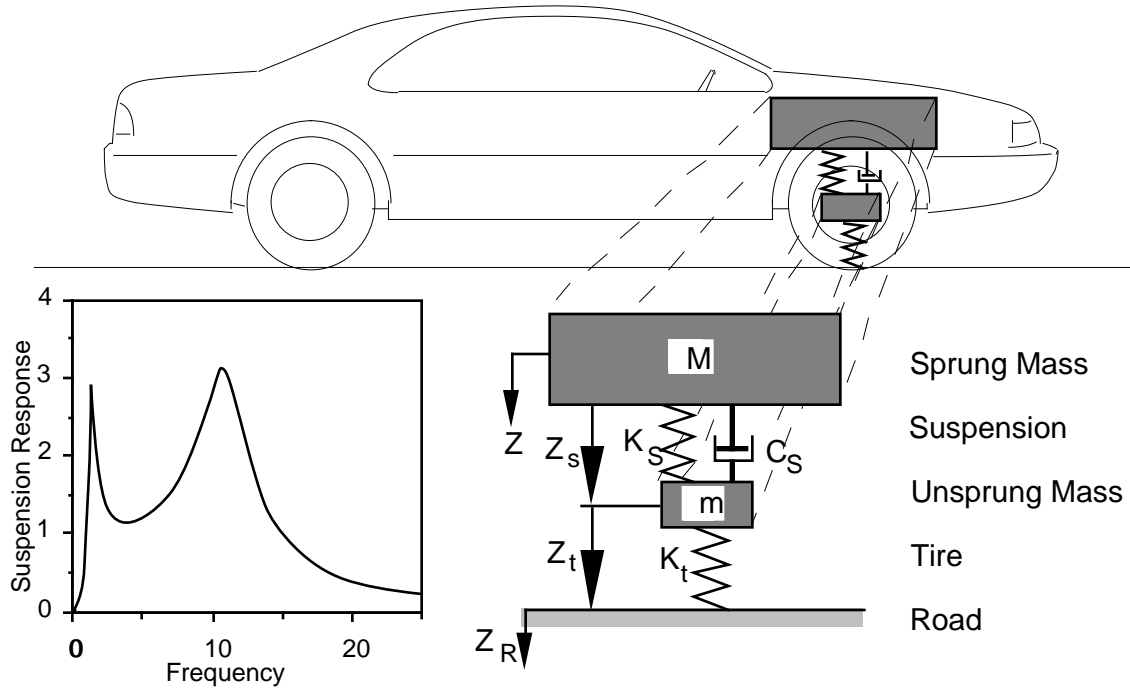

Fig. 8 The quarter-car model

The frequency response of the quarter car extends from approximately 0.5 to 20 Hz. with some emphasis on roughness at the body bounce frequency and the axle resonance frequency. Although this differs from the response properties of the other devices shown earlier, it is more uniform in the waveband of measurement than many of the devices; and more importantly, it is characteristic of motor vehicle dynamics. The rationale favoring the quarter car is the fact that it covers the appropriate frequency range responsible for exciting vehicle vibrations and emphasizes those that excite modal resonances.

The measurement of suspension stroke as the roughness response was chosen for convenience back in the early development period of the "Via-Log" and roadmeters. Although it was not known at that time to be a valid measure of "ride" it turns out to be a reasonable approximation. The "ride" of a motor vehicle is most commonly measured by the acceleration on the body. On a typical road this turns out to be a body acceleration spectrum (a power spectral density, or PSD) similar to that shown in Figure 9. Also shown in the figure is the PSD from which the IRI accrues. Although slightly different in shape, they both cover the same frequency range and both place emphasis on the one Hertz body resonance and the 10 Hertz axle resonance.

Roughness is also significant to motor vehicle performance in other ways. The existence of roughness necessitates suspension systems on motor vehicles to reduce the vibration exposure of passengers. A primary consideration in design of suspension systems is the stroke necessary to accommodate the displacements caused by roughness. (Ride improves with stroke. The more generous suspension stroke in a luxury car is the primary factor that allows it to ride better than compact cars.) Thus, the likely stroke in the suspension must be rationalized with available package space in a vehicle. A relevant roughness measurement should therefore encompass the qualities that determine



suspension stroke requirements. The PSD for suspension stroke shown in Figure 9 reveals that the body resonant mode, which is captured by the IRI, is dominant.

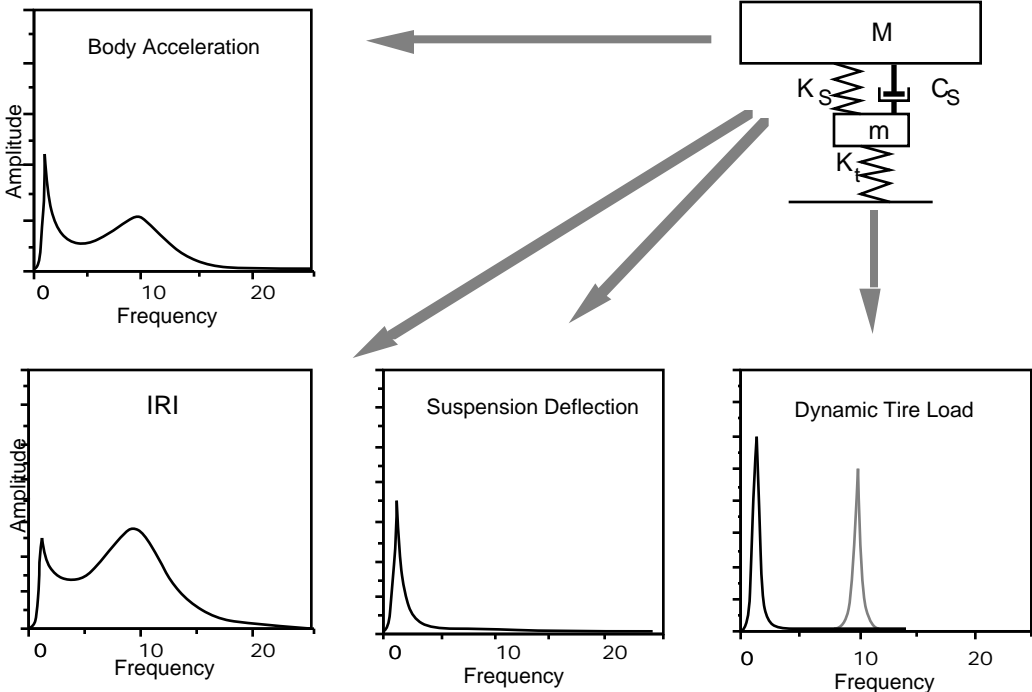

Fig. 9 Comparison of IRI with other vehicle responses

Finally, the dynamic load variations caused by roughness reduce the road holding ability of tires and contribute to road damage from heavy trucks. The PSD of dynamic tire load shown in Figure 9 is dominated by motions at the body resonant frequency for most vehicles. One exception of special concern to the highway community is the truck with a walking-beam tandem suspension which may also generate dynamic loads at about 10 Hz (the light curve in the figure).

Because of the similarity in the response between these various modes of vehicle performance, roughness measured on the IRI scale is closely related to each mode of performance. Figure 10 shows data from the International Road Roughness Experiment [9] relating Pavement Serviceability Index (PSI) to IRI. Inasmuch as serviceability ratings are dominated by vehicle ride perception [4], a close correlation with IRI roughness is expected. The data in the figure show a precise relationship which is approximated by the simple equation:

$$PSI = 5.0 - IRI/100 \quad \text{for } 0 < IRI < 300 \text{ (in/mile)}$$

Other research looking specifically at the correlation of ride ratings and roughness wavelengths in the road [10, 11] have concluded that the quarter-car response is less than optimal. The best correlation was obtained when roughness measurement is limited to wavelengths corresponding to the axle-hop resonance of the car. While the correlation coefficients were higher for this limited band of wavelengths, those for the quarter-car reflected in IRI measures were still quite high. Limiting the band of wavelengths to achieve slightly higher correlation with ride has the disadvantage that it excludes roughness that

excites body motions important to dynamic loading. I.e., the roughness measurement specifically “tuned” to ride misses other important roughness qualities in the road.

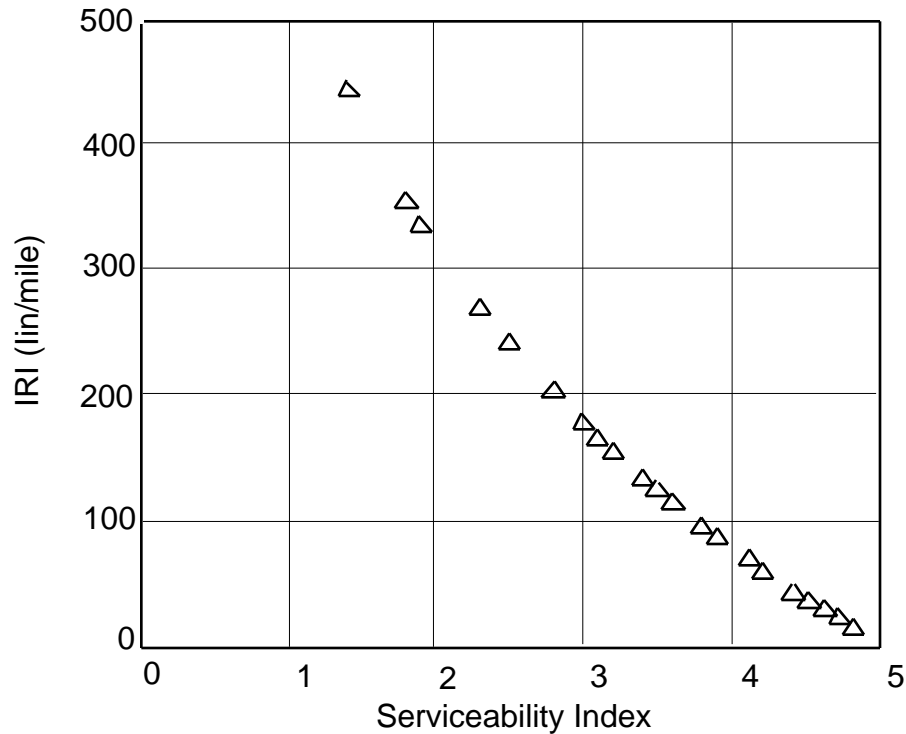

Fig. 10 Correlation of IRI with Serviceability Index [9]

The ability of IRI to measure roughness important to dynamic loading was demonstrated in a research project in which dynamic loads were measured on trucks with three different suspensions [12]. Figure 11 shows the relationship between roughness and the dynamic load expressed as a Dynamic Load Index. The Dynamic Load Index (DLI) is defined as the standard deviation of the load normalized by the static load. Thus, an index of zero implies the load is its static value, whereas an index of 0.25 represents load variation for which the standard deviation is 25% of the static load.

As seen in the figure, the dynamic load for the torsion-bar and walking-beam suspensions increases in direct proportion to the IRI roughness. This is as expected because the IRI scale includes roughness wavelengths that excite body bounce and pitch motions in trucks that are responsible for most of the load variation. (Although not proven here, dynamic loads for the walking-beam suspension are higher due to the strong axle-hop resonance in this suspension [13]. The wavelengths that excite this motion are also captured in the IRI, so it is an appropriate index of roughness for this vehicle as well.)

The relationship between IRI and the DLI for the leaf-spring suspension is not as linear as for the other suspensions. This arises from the fact that leaf-spring suspensions have high levels of coulomb friction. On smooth roads these suspensions exhibit high stiffness and little damping (accounting for the high initial increase of DLI with roughness). On rough roads, however, the suspension softens and increases damping, which limits the increase in DLI as the roads get rougher.

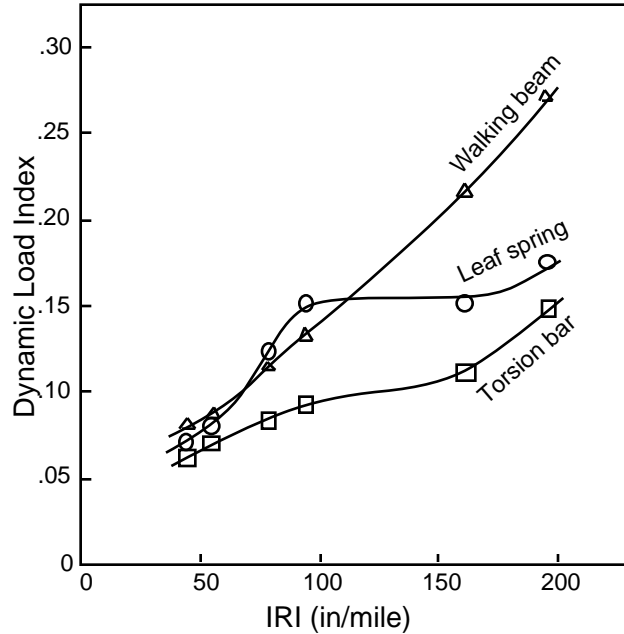

Fig. 11 Relationship of RTRRMS roughness to truck dynamic load [12]

Finally, Figure 11 illustrates one other important aspect of the precision that can be achieved by using the IRI roughness scale. Although there were no “perfectly” smooth roads (zero IRI) in these tests the slopes of the curves nominally project to a DLI value of about 0.05 at zero roughness. This corresponds to dynamic loads generated not by the road, but by nonuniformities (imbalances and runouts) in the tires of the trucks under test. Specifically, it is evidence that a typical truck has dynamic load variations on its axles of about 5% of the static load due to the truck itself, not road roughness.

### Speed and Wheel Track Options of the IRI

While the discussion above presents the rationale that drove the choice of a quarter-car based roughness scale, the fact that it emulates a vehicle leaves choices as to how it is implemented, specifically with regard to the travel speed assumed for the calculation and the option for evaluating roughness of individual wheel tracks or combined left and right tracks.

**Speed**—On any road the level of roughness to which a vehicle is exposed depends on the travel speed. The perceived roughness generally increases with speed. This arises from the fact that the forces and accelerations imposed on a wheel by a bump increase with the speed at which it must “follow” the bump. Thus, roughness to the road user is not a constant, but may be judged differently on low- and high-speed roads. However, to the highway community roughness is a geometric property of the road. The geometry is constant, therefore a road should have a single roughness value.

To accommodate the differences in these viewpoints, the IRI is based on quarter-car response at 50 mph (80 km/h). A fixed speed for evaluating IRI ignores the fact that the prevailing travel speed varies with different types of roads. Thus, the choice of a fixed speed is a compromise between needs of the highway engineer and the realities of the physics governing vehicle behavior.

However, it should be recognized that the compromise is not unique to the IRI. Any geometrically based measurement of roughness—specifically measures that depend on a particular band of wavelengths—do exactly the same thing. The choice of all geometrically based measures has been driven by the goal of evaluating a quantity that is closely correlated to vehicle response. Thus the band of wavelengths selected is implicitly linked to an assumed vehicle travel speed, although that bias is usually unrecognized. The only difference is that the IRI explicitly reflects a chosen speed.

**Single- vs. dual-track measurement**—Another aspect of IRI measurement that can be confusing to the user is the choice of single- versus dual-track measurement. The common roughness measurement practices in use differ in treatment of wheel tracks. All profiling devices and all single-wheel RTRRMS (e.g., the BPR Roughometer) can measure single-track roughness. However, RTRRMS that use an automobile for the host vehicle are dual-track measurement devices. This arises from the fact that the roadmeter measures the average displacement of the left and right wheels.

The “minor” difference in methods, however, is not trivial in its consequences. Each wheel track has unique roughness features that contribute to bounce and roll of a motor vehicle. Measurements of individual wheel tracks quantify the total magnitude of the surface deviations. A car-based RTRRMS only measures the bounce component associated with the average deviation of the two wheel tracks. Thus, the IRI value from an car-based system is inherently 10% to 20% lower than the average of the IRI values of the two wheel tracks, and this factor must be taken into account in the calibration process.

The IRI calculation method has the flexibility to allow measurement in either fashion, however the single-track measurement has been selected as the standard. (Dual-track measurements from an RTRRMS are duplicated by the half-car simulation and should be denoted as HRI values rather than IRI values [14].) The single wheel track method provides more complete information about a road at the cost that two numerical values must be recorded. The unfortunate aspect is that averaging the IRIs from two wheel tracks is not identical to the average obtained with a car-based RTRRMS. This is not a fault of the IRI, but a consequence of the physical differences in the measurement process. IRI computed from an “average” left and right elevation duplicates car-based RTRRMS measurement, but at a loss in information about the road. Inasmuch as most roads deteriorate more rapidly in the right wheel track, the single track values provide a more precise indication of road condition.

## **Closure**

The objective of this paper was to point out for those who must use the IRI today the historical basis from which it evolved. Roughness measurement technology developed around the conviction that imperfections in the surface geometry of a road were primarily important because of the vibrations induced in road-using vehicles. That conviction later transformed into a principle when Carey and Irick [4] identified roughness as the most important component in Present Serviceability. With that proof it was natural to see measures of vehicle response emerge as roughness indices. The development that led to the IRI was simply a formalization of the existing practice used by the highway community for measuring road roughness.

In the course of the development, consideration was given to alternative measures of vehicle response. For example, root mean square (RMS) of suspensions stroke was considered in lieu of the average rectified value (used by roadmeters) because of its greater mathematical utility. Likewise, the RMS body acceleration was considered in place of suspension stroke because of its more direct link to ride. However, no significant advantage was gained from the alternatives. The average rectified stroke was so similar to the others that it was incorporated in the IRI, thereby allowing highway agencies to maintain continuity of their roughness data bases.

The IRI is unique among roughness indices in the ease of measurement and the extent to which its measurability has been demonstrated. The World Bank experiments have validated that it can be measured by an extensive range of equipment including rod and level, Mays Meter cars, NAASRA car, French APL, BPR Roughometer, TRRL Bump Integrator, TRRL Beam, Swedish Road Surface Tester, ARAN, Face Dipstick, GMR-type Profilometers, South Dakota-type Profiling System and others. For each type of hardware, required procedures have been defined along with the level of accuracy to be expected, and these principles have been tested throughout the world. The rod and level method for measuring profiles from which to calculate IRI is now reduced to a standard method [15]. Thus, the IRI today provides highway engineers with a proven and robust basis for comparing roughness information across institutional boundaries.

The IRI is often criticized because it is not the “best” index for quantifying specific road roughness qualities or does not conform to local preferences for a roughness index. The most notable example of this comes from the extensive research that has been done to develop a roughness index that specifically relates to ride. The work by Janoff [10, 11] has identified profile wavelengths of 1 to 16 feet as most closely linked to passenger car ride, resulting in a Ride Number index that is the mean square amplitude of the profile in this range. Yet, from our knowledge of the broader issues in vehicle dynamics it is expected that Ride Number will prove inferior to other indices, particularly the IRI, in quantifying roughness relevant to truck ride and dynamic loads.

The fact that one index is better at quantifying a specific profile quality should not impede the acceptance of the IRI as a current measurement standard. As knowledge and technology develops for roughness measurement, it should be expected that a number of specialized profile indices will emerge as the “best” measure of specific roughness qualities. The development of new indices should not serve to discredit others. Rather, we need to recognize that each roughness index adds to our knowledge of road surface condition, and be prepared to maintain data bases of multiple indices as technology develops. At this time the IRI is the roughness measure of broadest utility (because it encompasses all wavelengths significant to motor vehicles) and should be the cornerstone of a roughness data base. Eventually, other indices should be added, as developed, to quantify surface profile properties related to specific performance qualities such as passenger-car ride, truck ride, dynamic loads, damage potential from dynamic loads, road holding, cracking and such. As it turns out, the highway engineers who developed the roughness measurement methods now in use and formalized by the IRI, made a choice that was not only rational then, but will remain so for the decades ahead.

## References

1. "Highway Performance Monitoring System Field Manual for the Continuing Analytical and Statistical Database, Appendix J." FHWA Order M5600.1A, OMB No. 2125-0028, FHWA, U.S. Department of Transportation, Dec. 1987.
2. Hveem, F. N., "Devices for Recording and Evaluating Pavement Roughness." Highway Research Board Bulletin 264, 1960, pp. 1-26.
3. "The AASHO Road Test, Report 5, Pavement Research." HRB Special Report 61E, 1962, 352 p.
4. Carey, W. N. Jr. and Irick, P. E., "The Pavement Serviceability-Performance Concept." HRB Bulletin 250, 1960, pp. 40-58
5. Mays Ride Meter Booklet, 3th Edition, Rainhart Co., Austin, TX, 1973, 12 p.
6. Brokaw, M. P., "Development of the PCA Road Meter: A Rapid Method for Measuring Slope Variance." HRR 189, 1967, pp. 137-149.
7. Gillespie, T. D., Sayers, M. W. and Segel, L., "Calibration of Response-Type Road Roughness Measuring Systems." NCHRP Report No. 228, Dec. 1980, 81 p.
8. Gillespie, T. D., Sayers, M. W. and Queiroz, C. A. V., "The International Road Roughness Experiment: Establishing Correlation and Calibration Standard for Measurement." The World Bank, Technical Report No. 45, 1986, 453 p.
9. Paterson, W. D. O., "International Roughness Index: Relationship to Other Measures of Roughness and Riding Quality." Transportation Research Record 1084, 1986.
10. Janoff, M. S., et. al., "Pavement Roughness and Rideability." NCHRP Report No. 275, 1985, 73 p.
11. Janoff, M. S., "Pavement Roughness and Rideability Field Evaluation." NCHRP Report No. 308, 1988, 48 p.
12. Ervin, R. D., et al., "Influence of Truck Size and Weight Variables on Stability and Control Properties of Heavy Trucks." University of Michigan Transportation Research Institute UMTRI-83-10/2, Federal Highway Administration FHWA-RD-83-030, 1983, 179 p.
13. Sayers, M. and Gillespie, T. D., "The Effect of Suspension System Nonlinearities on Heavy Truck Vibration." Seventh IAVSD Conference on the Dynamics of Vehicles on Roads and on Tracks, Cambridge, U. K, Proceedings, 1981, 13 p.
14. Sayers, M. S., "Two Quarter-Car Models for Defining Road Roughness: IRI and HRI." Transportation Research Record 1215, 1989, pp. 165-172.
15. "Standard Test Method for Measuring Road Roughness by Static Level Method." ASTM E1364, American Society for Testing and Materials.