

---

# Requirements Engineering by Generator-Based Prototyping

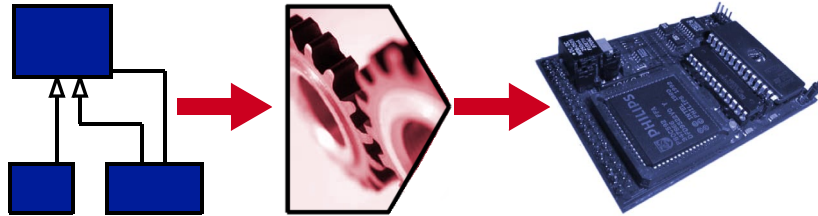

**Andreas Metzger**

(Subproject D1)

Department of Computer Science  
University of Kaiserslautern, Germany

---

## Motivation

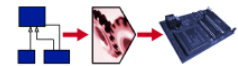

## Application of Prototyping

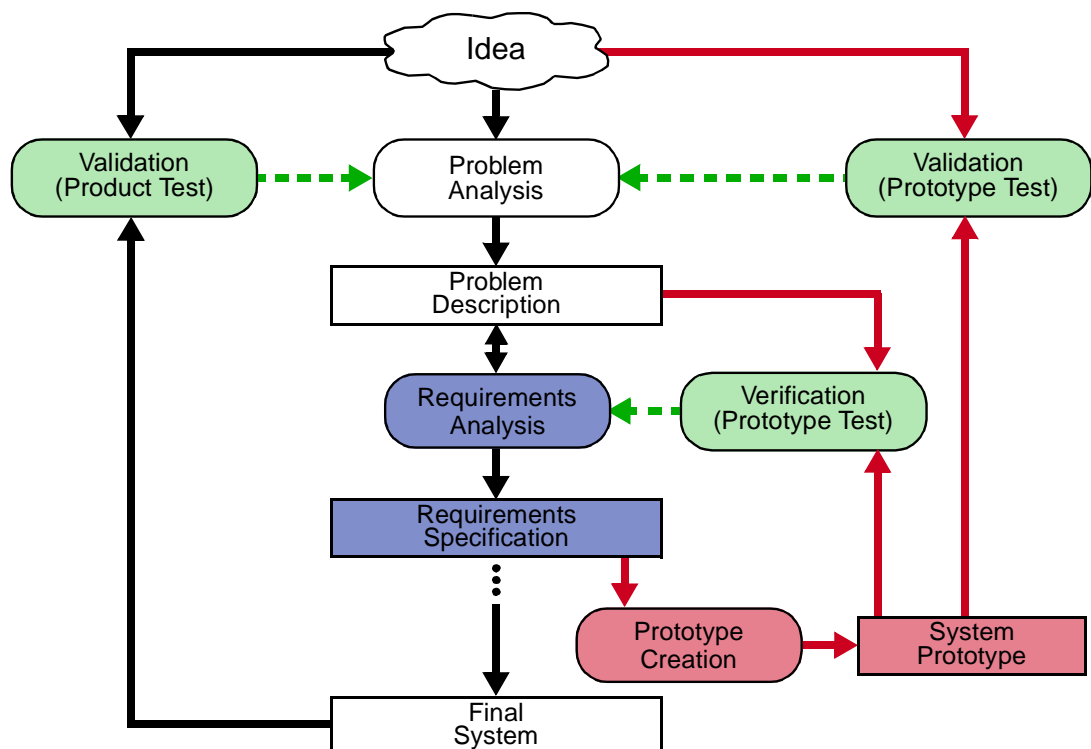

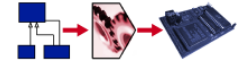

### Solutions for Early Prototyping (Related Work)

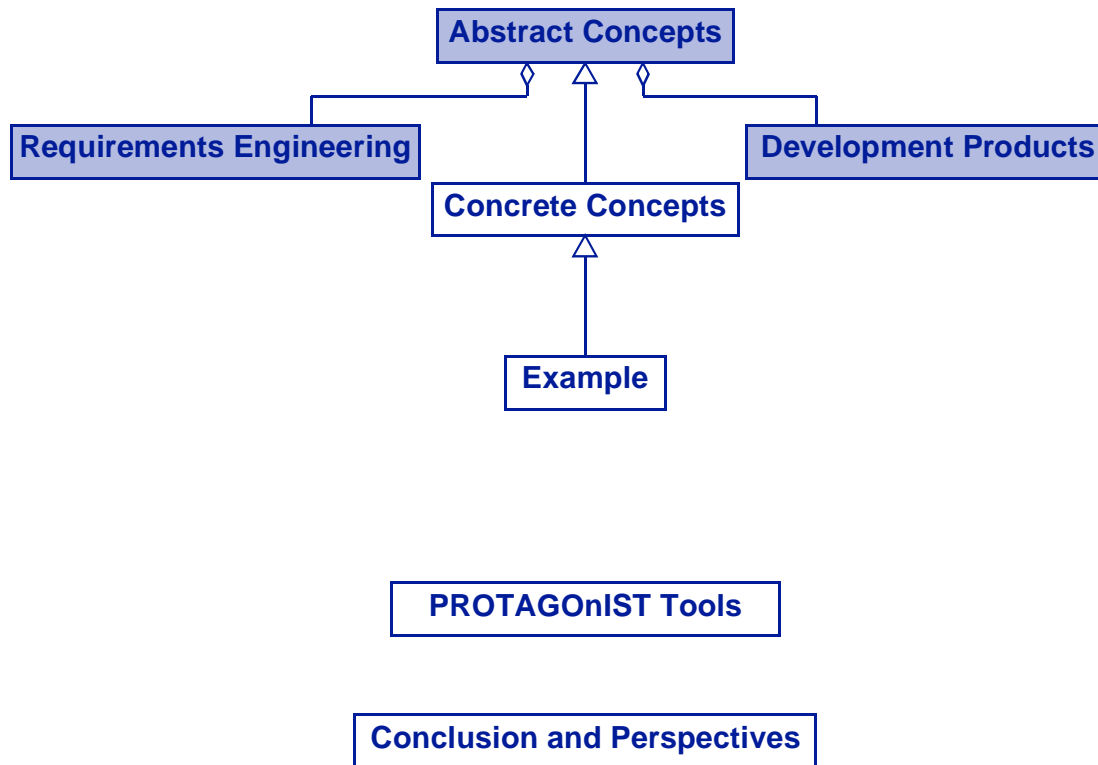
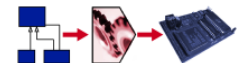
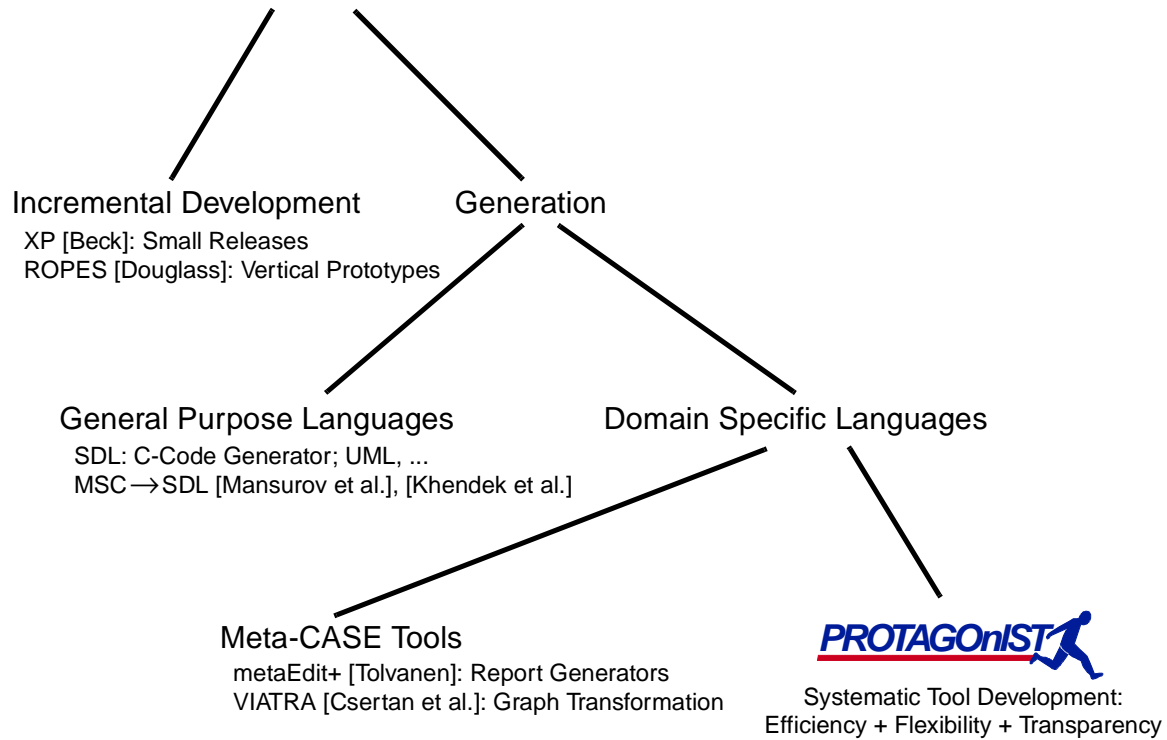

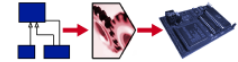

Sub-Activities of the Transformation

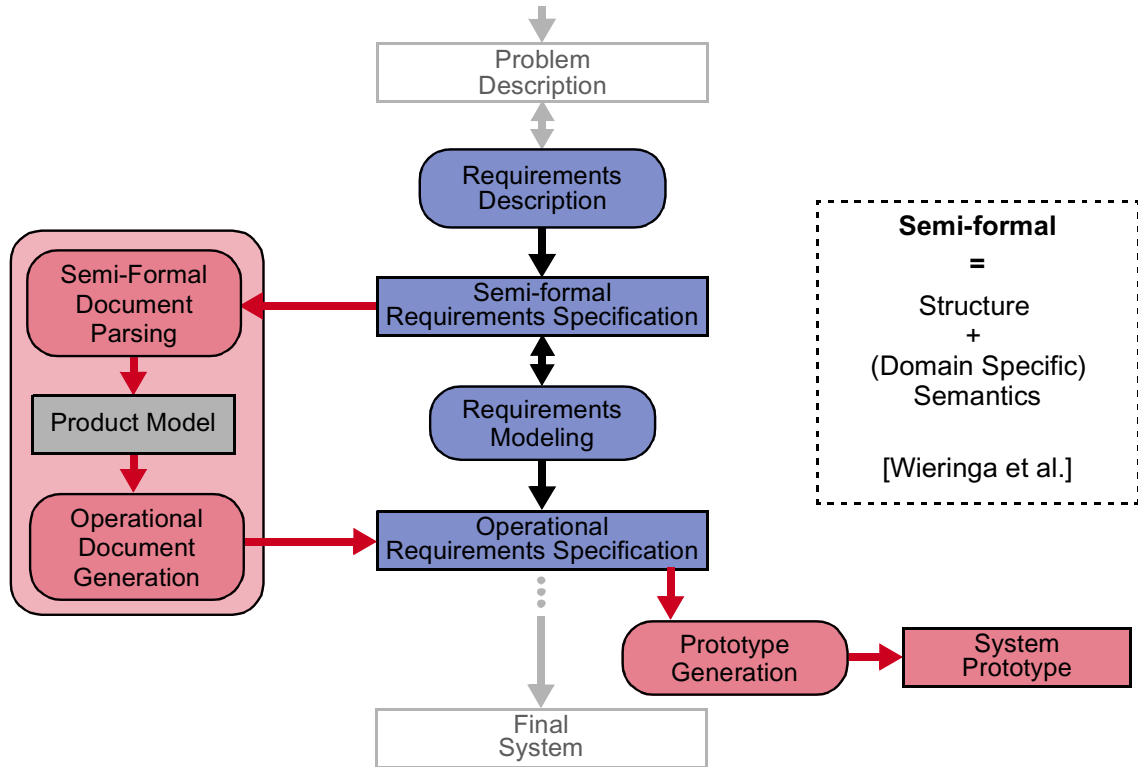

Andreas Metzger – International Colloquium of the SFB 501 – Kaiserslautern – March, 2003

Development Products

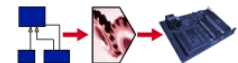

Classification of Product Model Entities

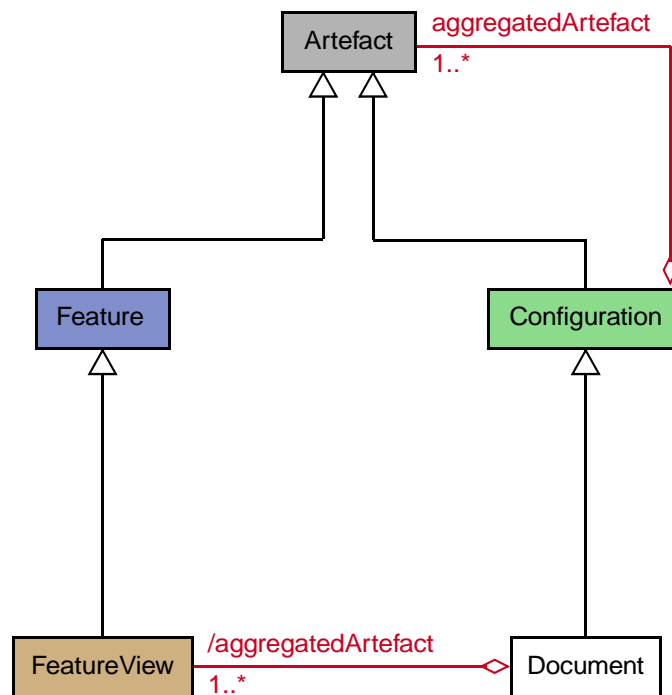

Andreas Metzger – International Colloquium of the SFB 501 – Kaiserslautern – March, 2003

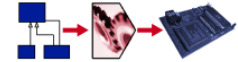

Sub-Activity: Document Parsing

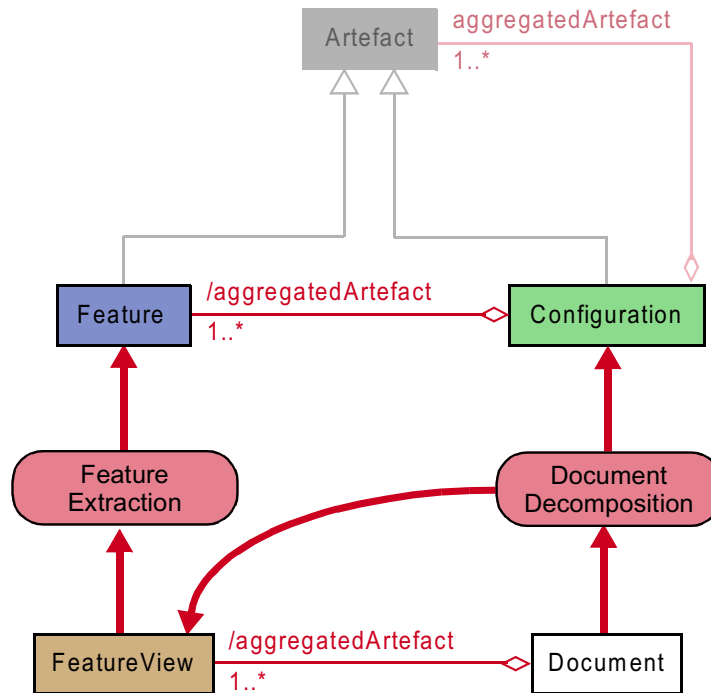

Andreas Metzger – International Colloquium of the SFB 501 – Kaiserslautern – March, 2003

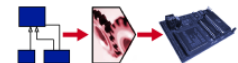

Sub-Activity: Document Generation

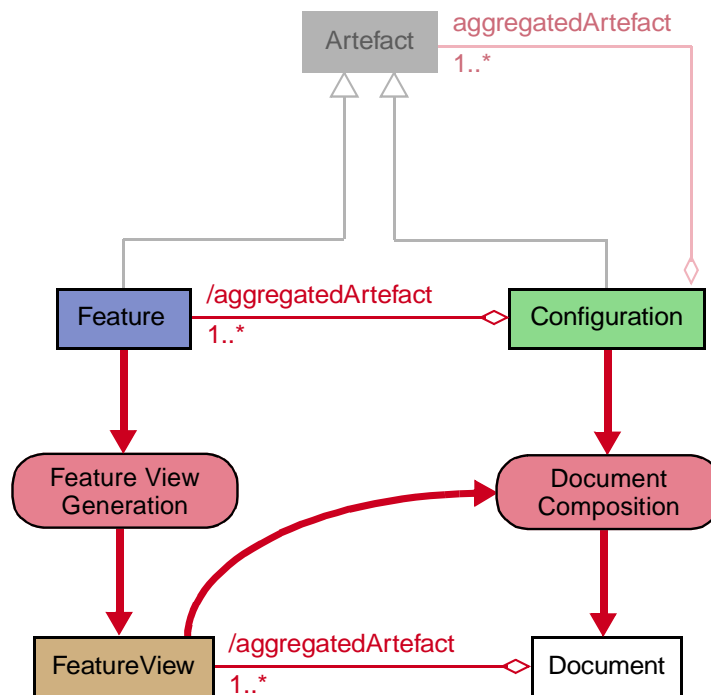

Andreas Metzger – International Colloquium of the SFB 501 – Kaiserslautern – March, 2003

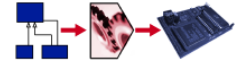

Specification Transformation

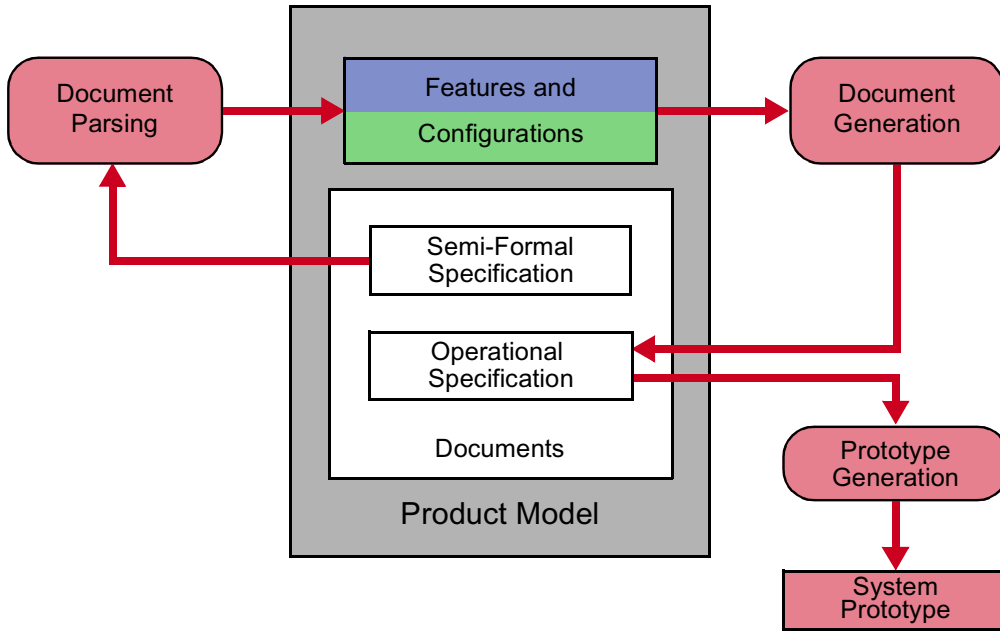

Andreas Metzger – International Colloquium of the SFB 501 – Kaiserslautern – March, 2003

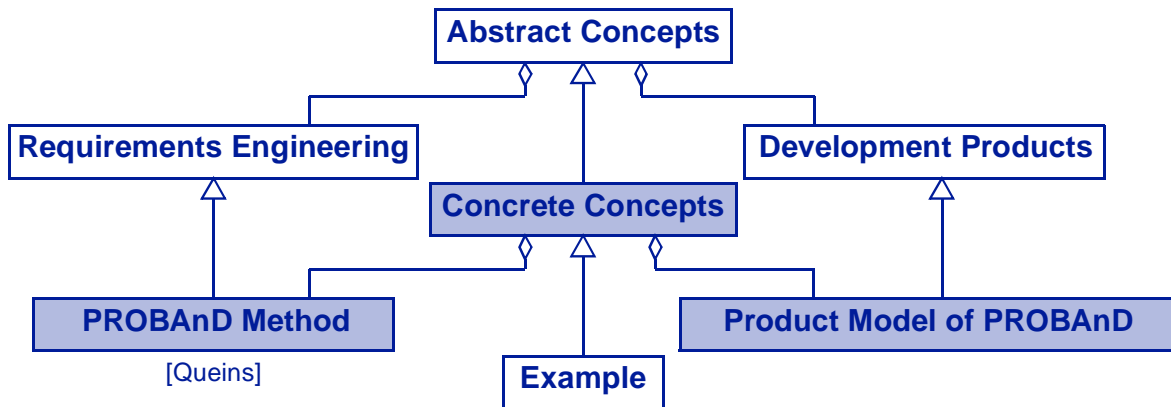
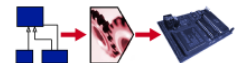

PROTAGOnIST Tools

Conclusion and Perspectives

Andreas Metzger – International Colloquium of the SFB 501 – Kaiserslautern – March, 2003

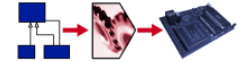

Types of Features (Excerpt)

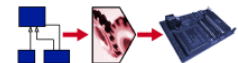
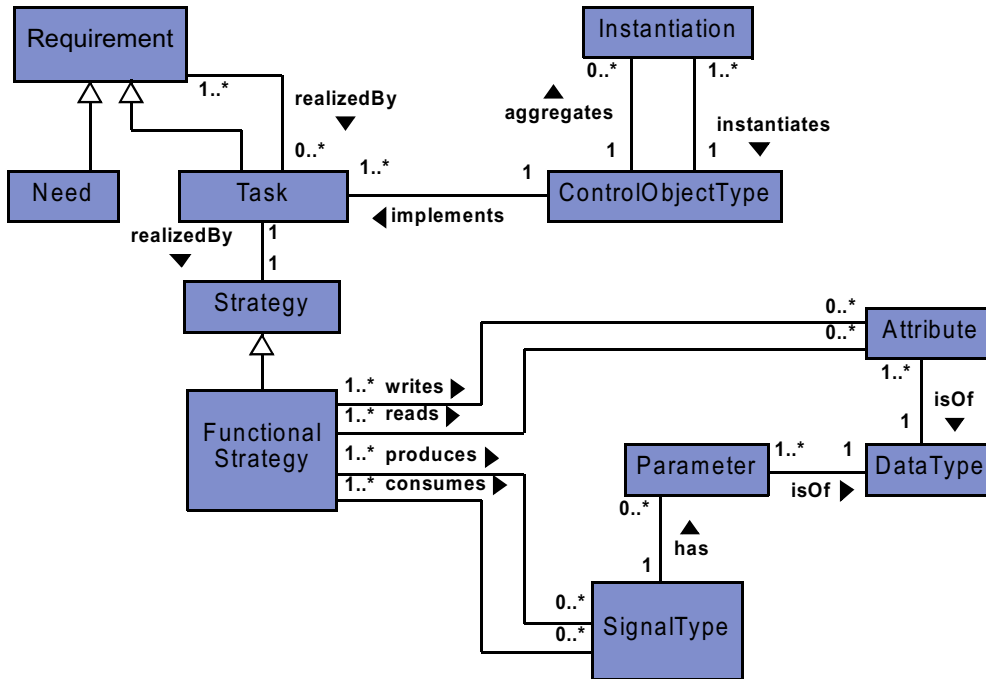

HTML Document Pasing

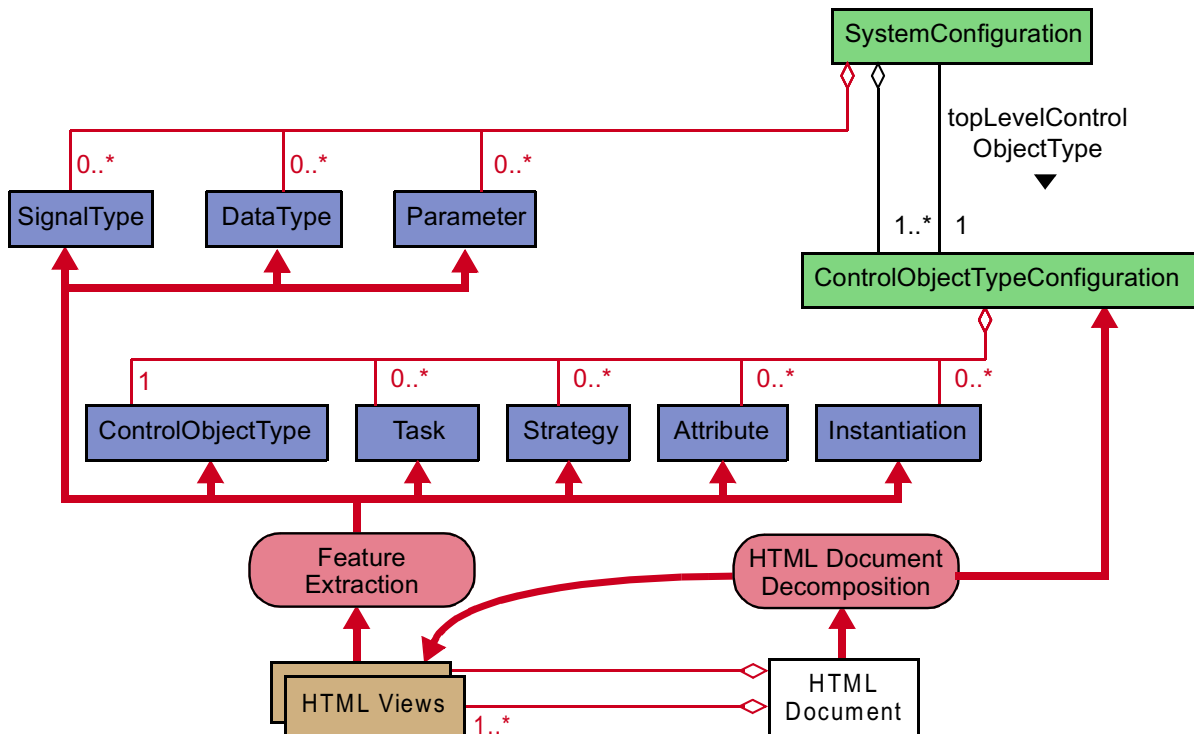

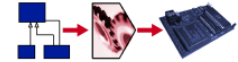

SDL Document Generation

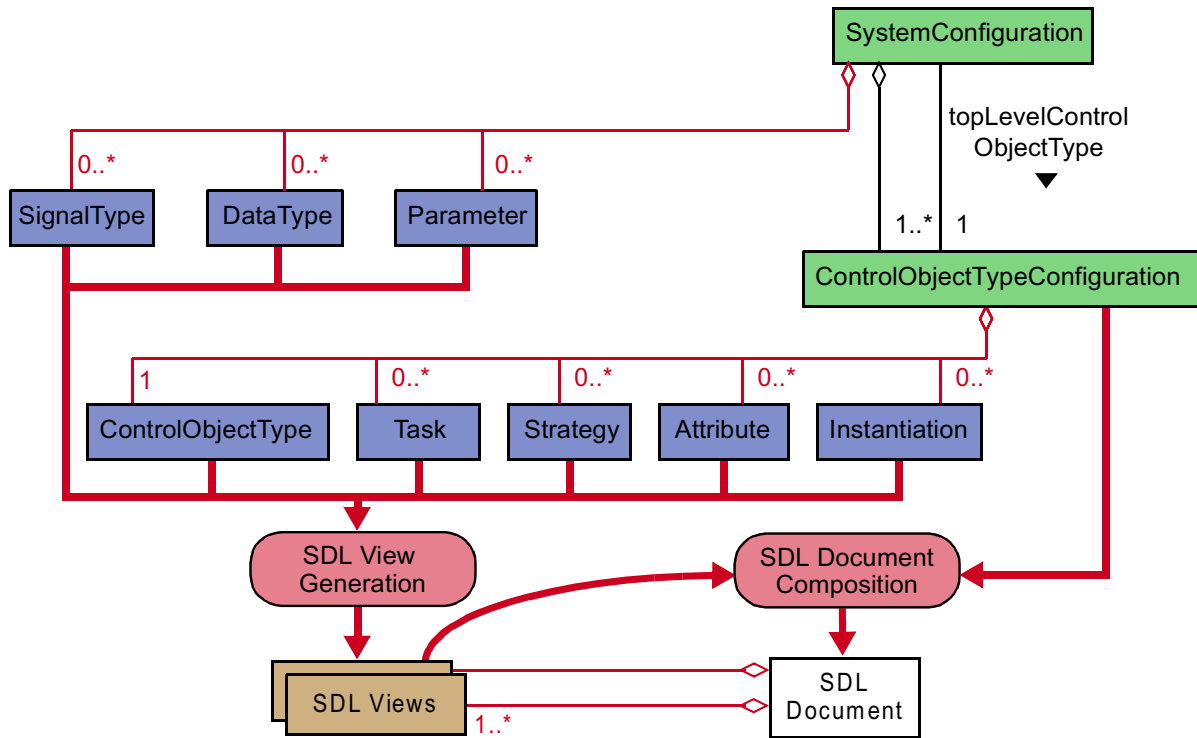

Andreas Metzger – International Colloquium of the SFB 501 – Kaiserslautern – March, 2003

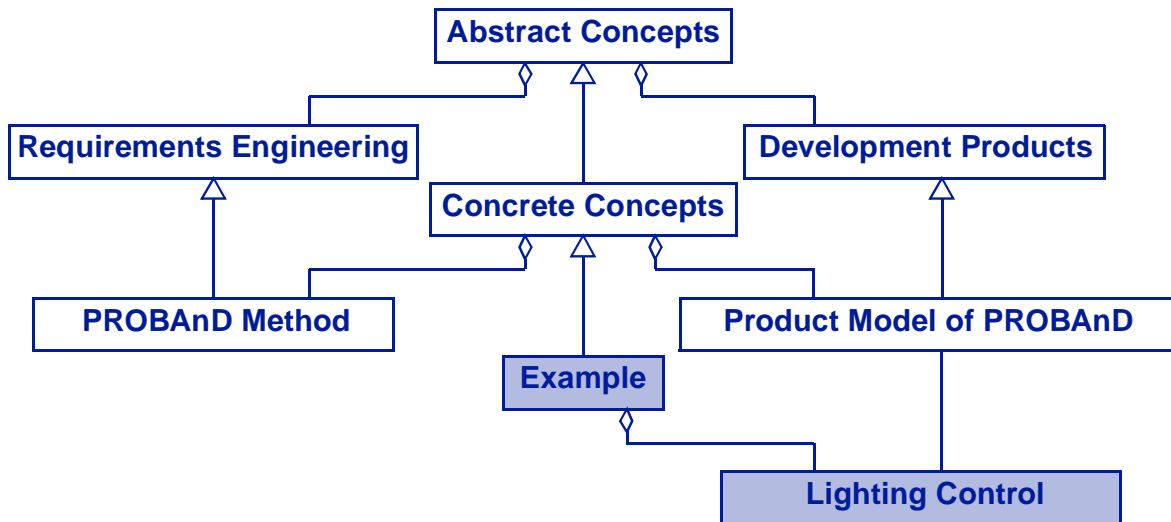
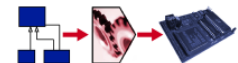

PROTAGOnIST Tools

Conclusion and Perspectives

Andreas Metzger – International Colloquium of the SFB 501 – Kaiserslautern – March, 2003

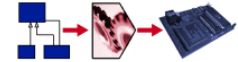

### HTML Document Parsing

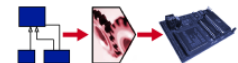
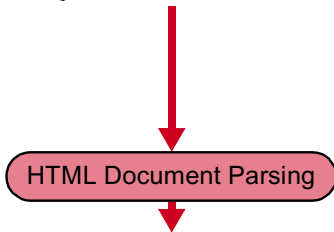
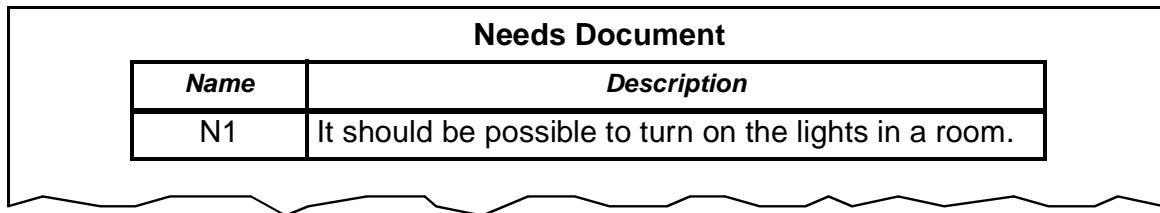

### HTML Document Parsing

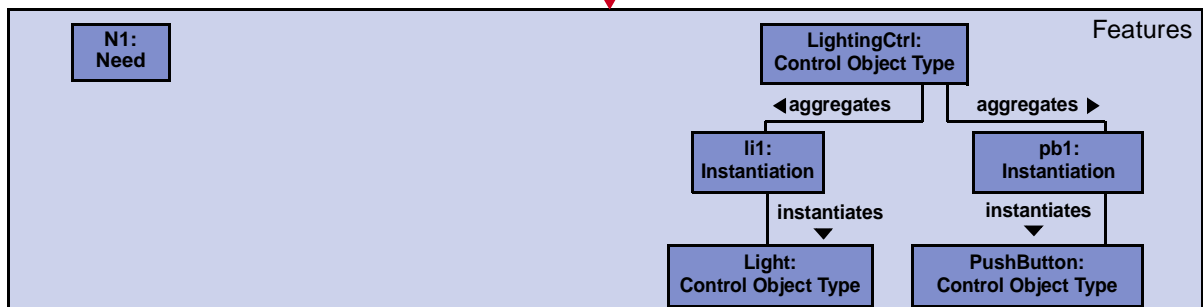
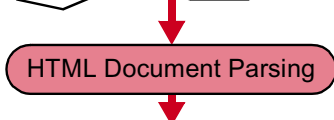
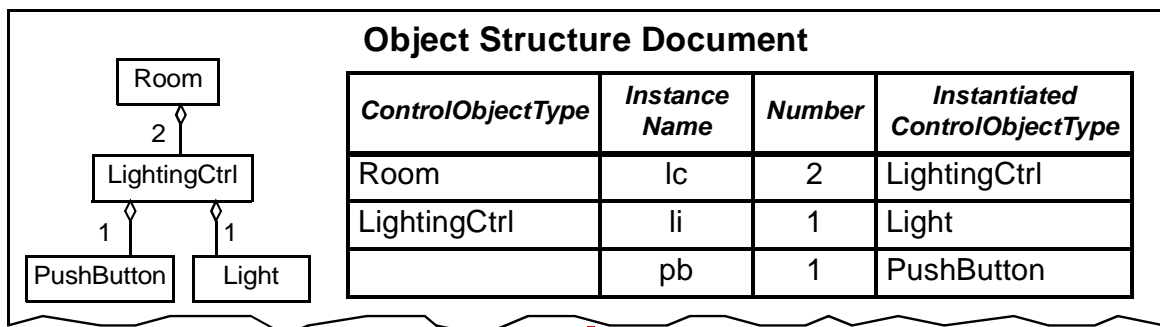



Example: "Simple Lighting Control System"

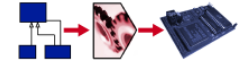

HTML Document Parsing

Model Name	Description	StrategyDescription	Realized Requirement
T1	Turn on light if push-button is pressed.	If the signal <i>newPushButton</i> is received, send the signal <i>setLight(on)</i> to turn on the light.	N1

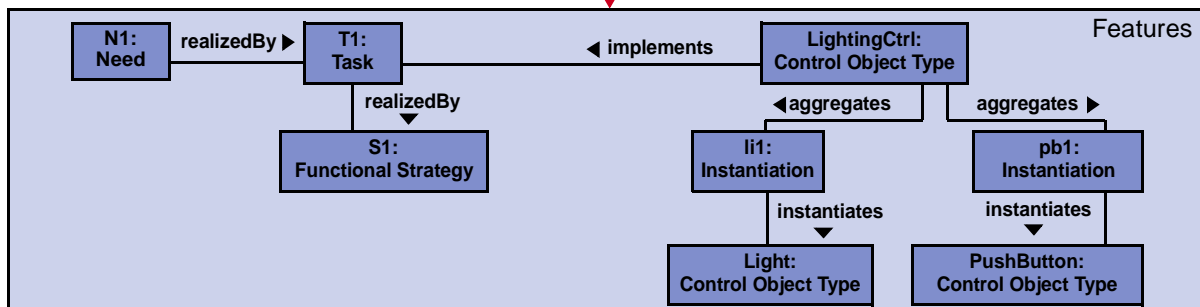
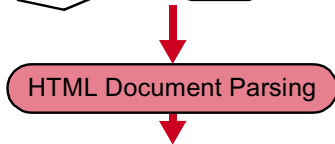

Andreas Metzger – International Colloquium of the SFB 501 – Kaiserslautern – March, 2003

Example: "Simple Lighting Control System"

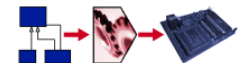

HTML Document Parsing

ModelName	Parameters	Tasks	Usage
<i>newPushButton</i>		T1	consumed
<i>setLight</i>	boolean	T1	produced

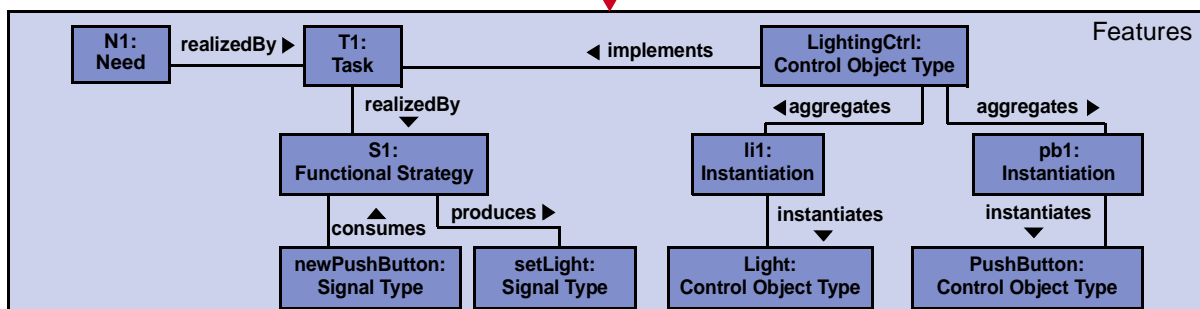
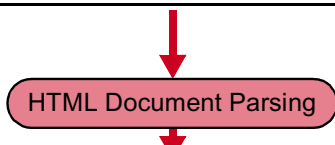

Andreas Metzger – International Colloquium of the SFB 501 – Kaiserslautern – March, 2003

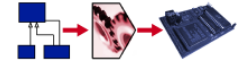

SDL Document Generation

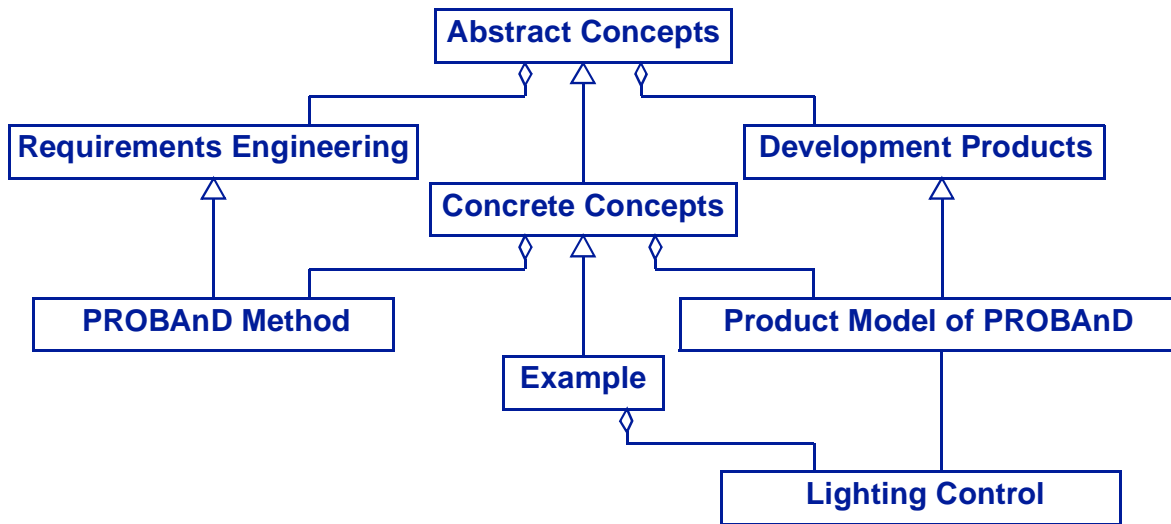
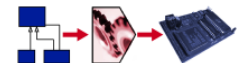
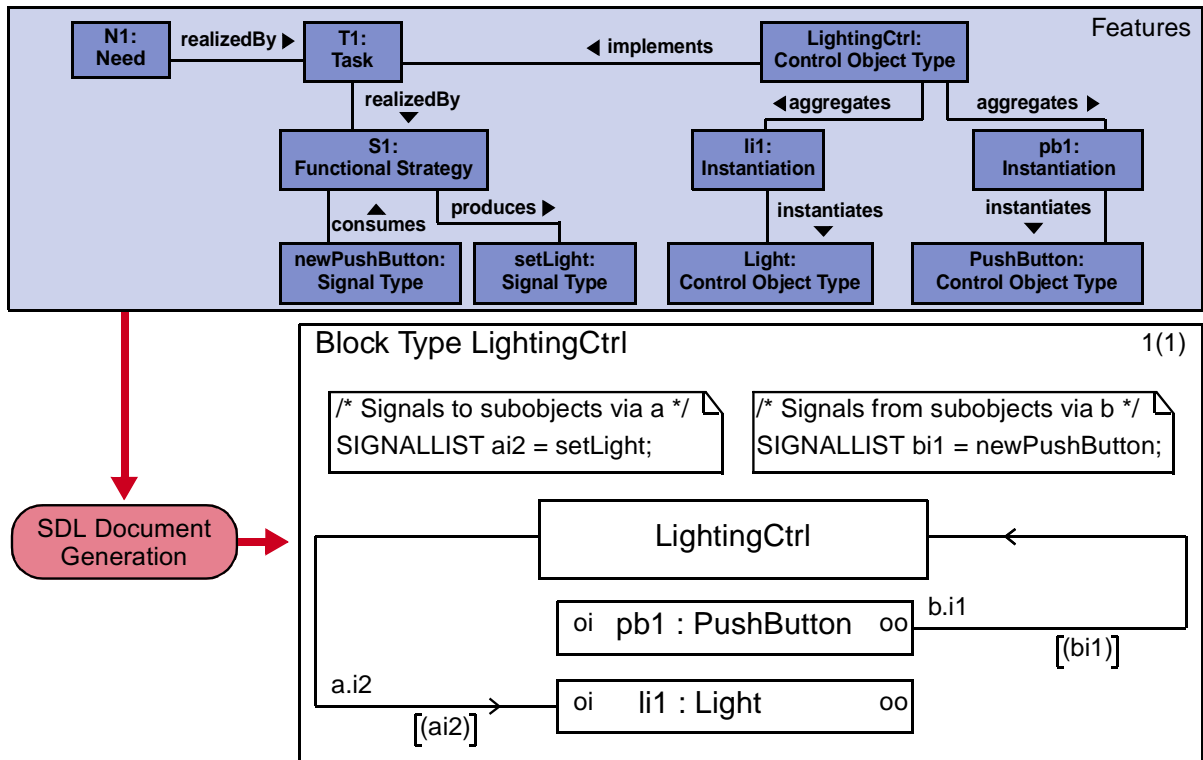

PROTAGOnIST Tools

Conclusion and Perspectives

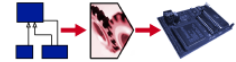

Overview

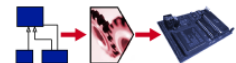
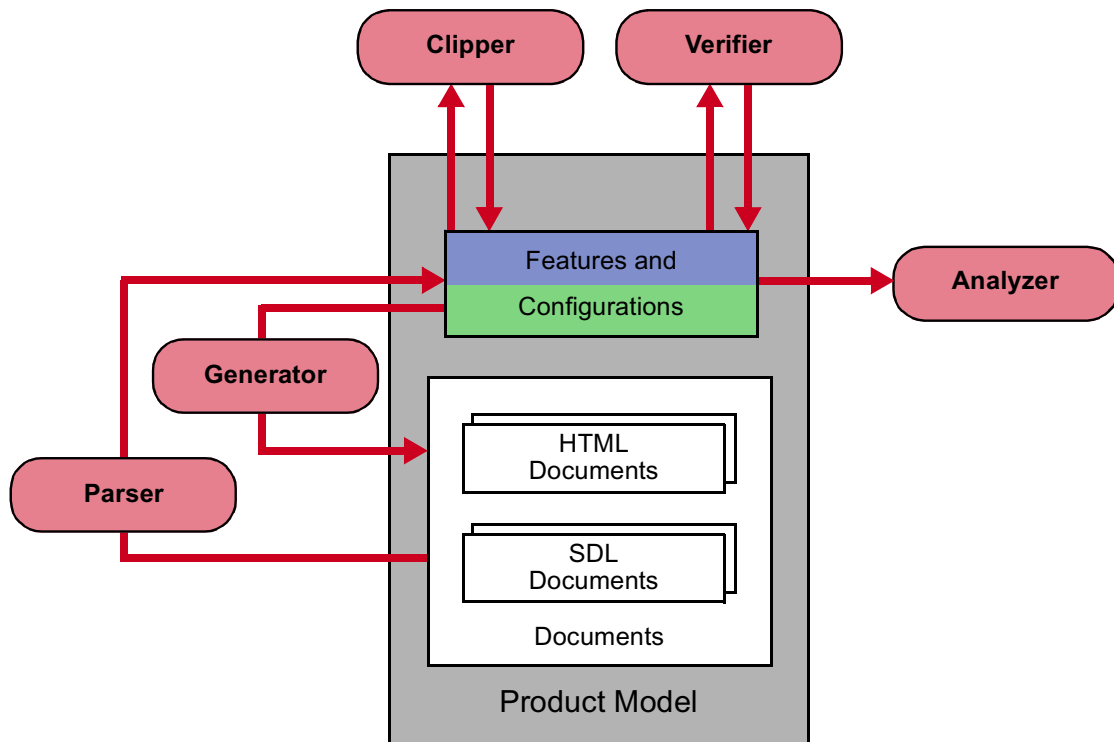

Tool Creation

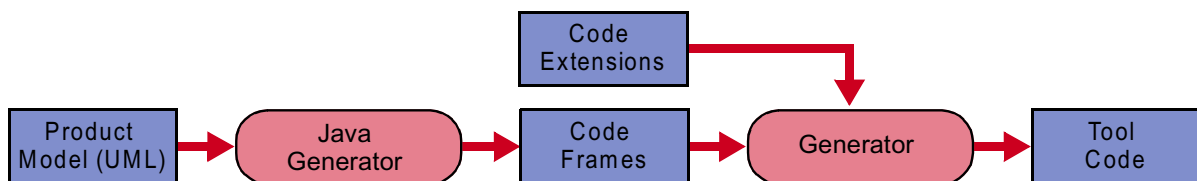

Effort

Tool	Lines Of Code
Code Frames	4700
Parser (HTML)	+ 4100
Generator (HTML + SDL)	+ 5300
Clipper	+ 800
Analyzer	+ 1900

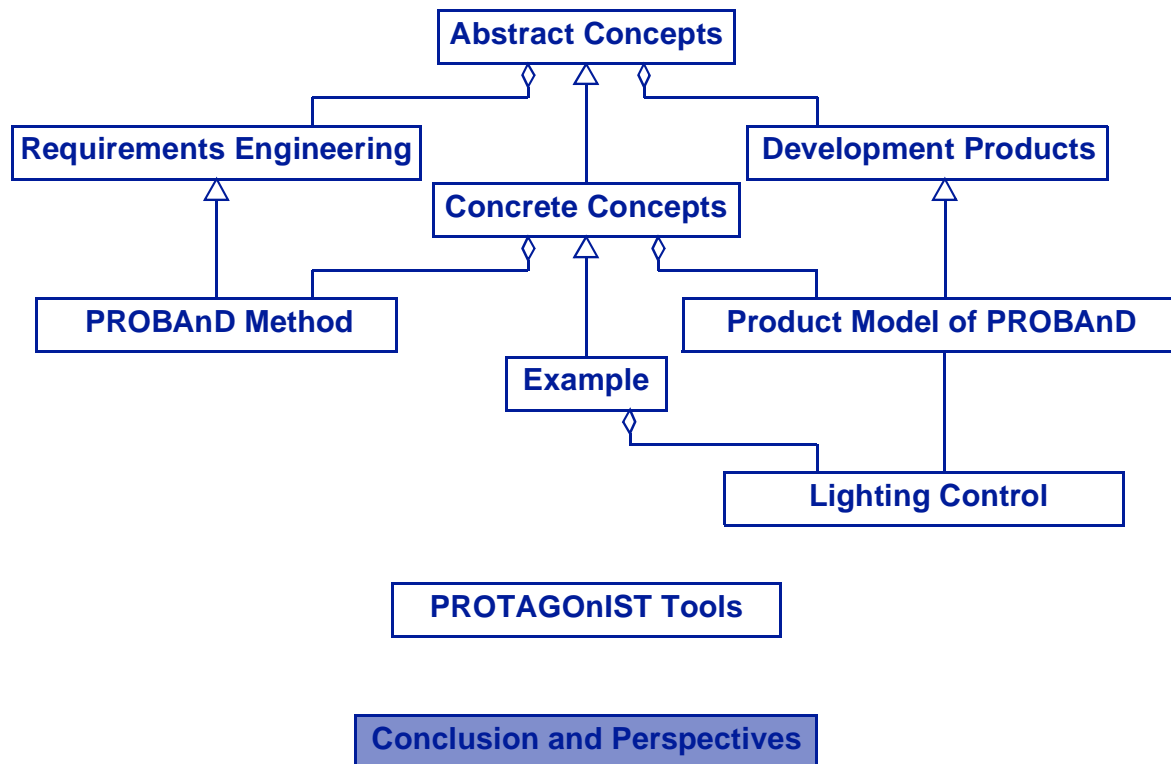
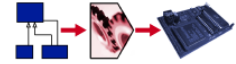

Andreas Metzger – International Colloquium of the SFB 501 – Kaiserslautern – March, 2003

## Perspectives

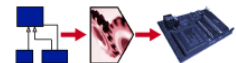

- Iterative Development
  - HTML/SDL → HTML/SDL
- Refinement of Product Model
  - Behavior: “Partial” (E)FSMs
  - further Domain Specialization: e. g., Actuator/Sensor-ControlObjectTypes
- Case Studies: Quantification of Gain of Efficiency
  - Effort of Code-Generation vs. Effort of Manual Modeling Activities
- Automation of Additional Development Activities
  - e. g., Reuse (i. e., Merge Product Model Instances)
- **“Efficient Modeling through Programming”**

Andreas Metzger – International Colloquium of the SFB 501 – Kaiserslautern – March, 2003

## References

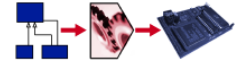

- [Beck] K. Beck. *Extreme Programming Explained. Embrace Change*. Boston, Mass.: Addison-Wesley. 1999
- [Csertan et al.] G. Csertan, G. Huszerl, I. Majzik et al. "VIATRA – Visual Automated Transformation for Formal Verification and Validation of UML Models" in *Proceedings of the 17th IEEE International Conference on Automated Software Engineering (ASE 2002)*. Edinburgh, Scotland, UK: September 2002. Los Alamitos, Calif.: IEEE Computer Society. 2002
- [Douglass] B.P. Douglass. *Doing Hard Time – Developing Real-Time Systems with UML, Objects, Frameworks, and Patterns*. Boston, Mass.: Addison-Wesley. 1999
- [Khendek et al.] F. Khendek, G. Robert, G. Butler et al. "Implementability of Message Sequence Charts" in *Proceedings of the SDL Forum Society Workshop on SDL and MSC (SAM '98)*. Berlin, Germany: SDL Forum Society. 1998
- [Mansurov et al.] N. Mansurov, D. Vasura. "Approximation of (H)MSC semantics by Event Automata" in *Proceedings of the SDL Forum Society International Workshop on SDL and MSC (SAM 2000)*. Grenoble, France: SDL Forum Society. 2000
- [Queins] S. Queins. *PROBANd – Eine Requirements-Engineering-Methode zur systematischen, domänenspezifischen Entwicklung reaktiver Systeme*. Ph.D. Thesis. Department of Computer Science. University of Kaiserslautern. 2002
- [Tolvanen] J.-P. Tolvanen. "Automating Variant Development in Embedded Software Product Families" in C. Grote, R. Ester (Eds.) *Proceedings of the Embedded World 2003 Conference*. Nürnberg, Germany, February 2003. Poing: WEKA Verlag. 2003. pp. 999–1008
- [Wieringa et al.] R. Wieringa, E. Dubois. "Integrating Semi-formal and Formal Software Specification Techniques" in *Information Systems*. 19(4). Elsevier Science Ltd. 1994. pp. 35–54

---

*Andreas Metzger – International Colloquium of the SFB 501 – Kaiserslautern – March, 2003*

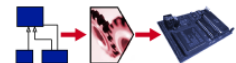

— Additional Slides —

---

*Andreas Metzger – International Colloquium of the SFB 501 – Kaiserslautern – March, 2003*

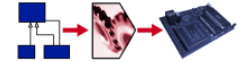

“Partial” (E)FSMs

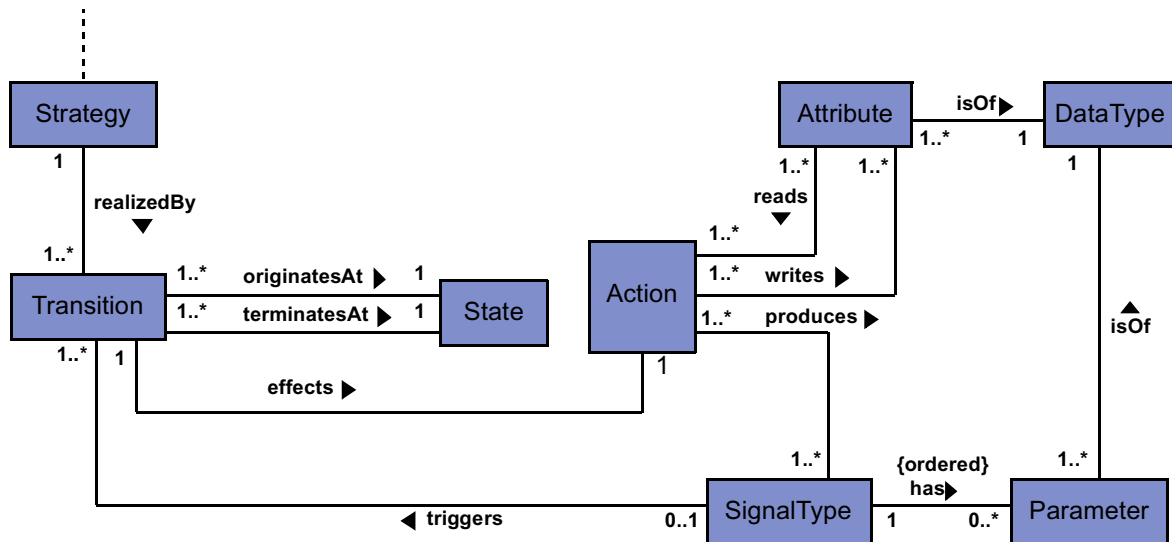

- additionally:
  - Guards?
  - Loops?
  - ...

Partial Prototypes

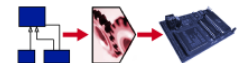

Missing Sub-Tree

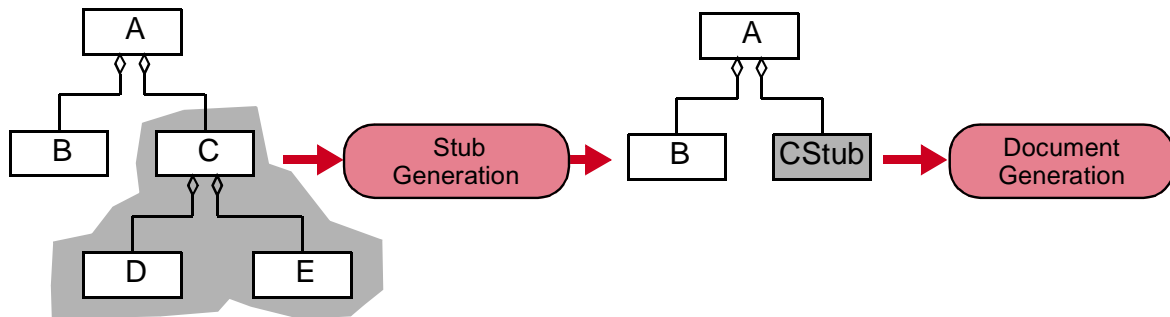

Missing Super-Tree

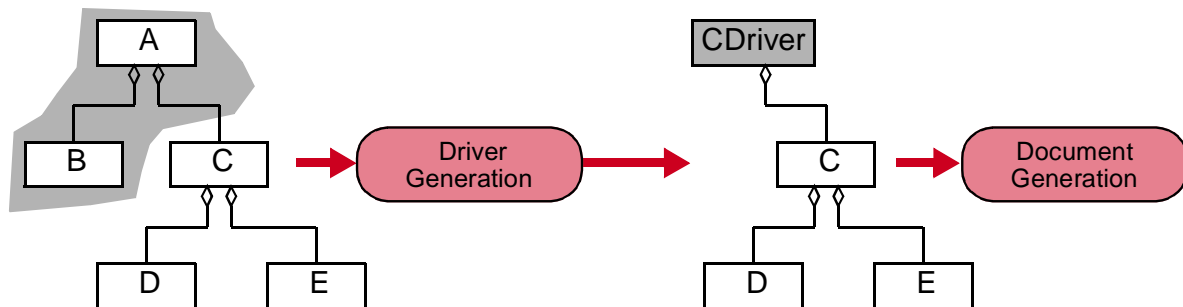

## Partial Prototypes

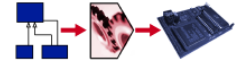

### Example: Driver Generation

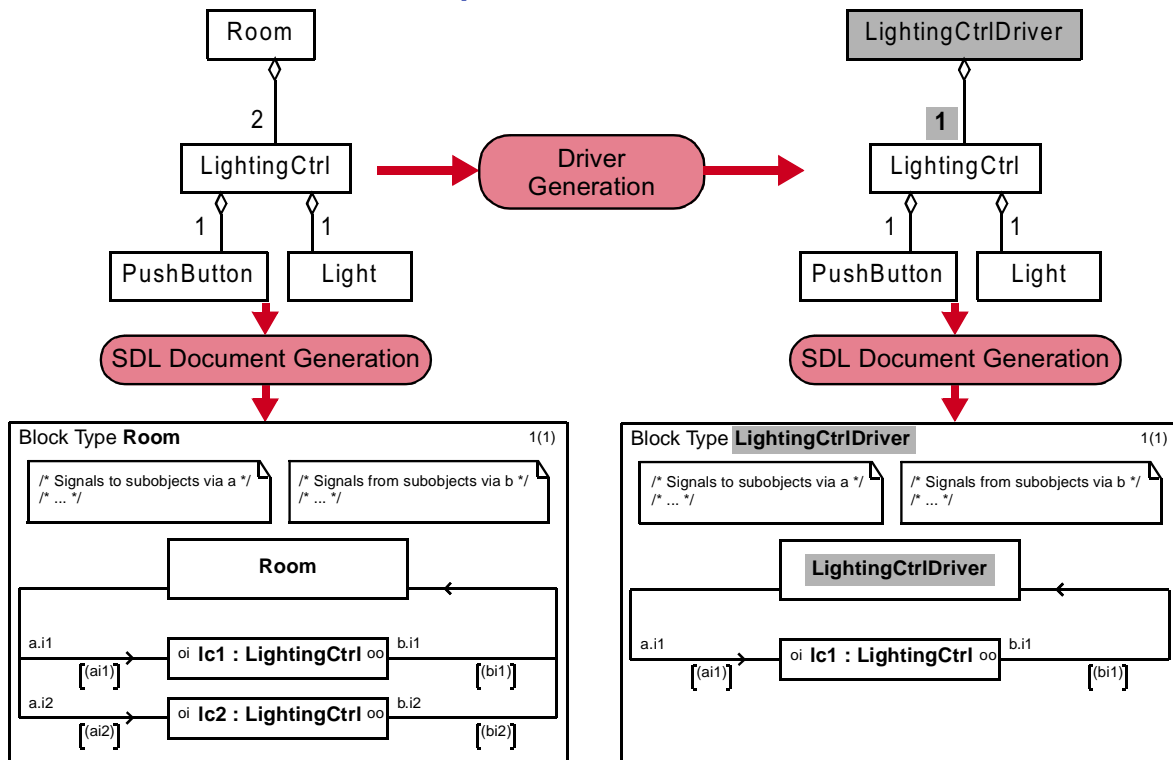

Andreas Metzger – International Colloquium of the SFB 501 – Kaiserslautern – March, 2003

## PROTAGONIST Tools

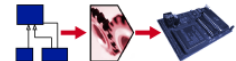

### Tool Creation

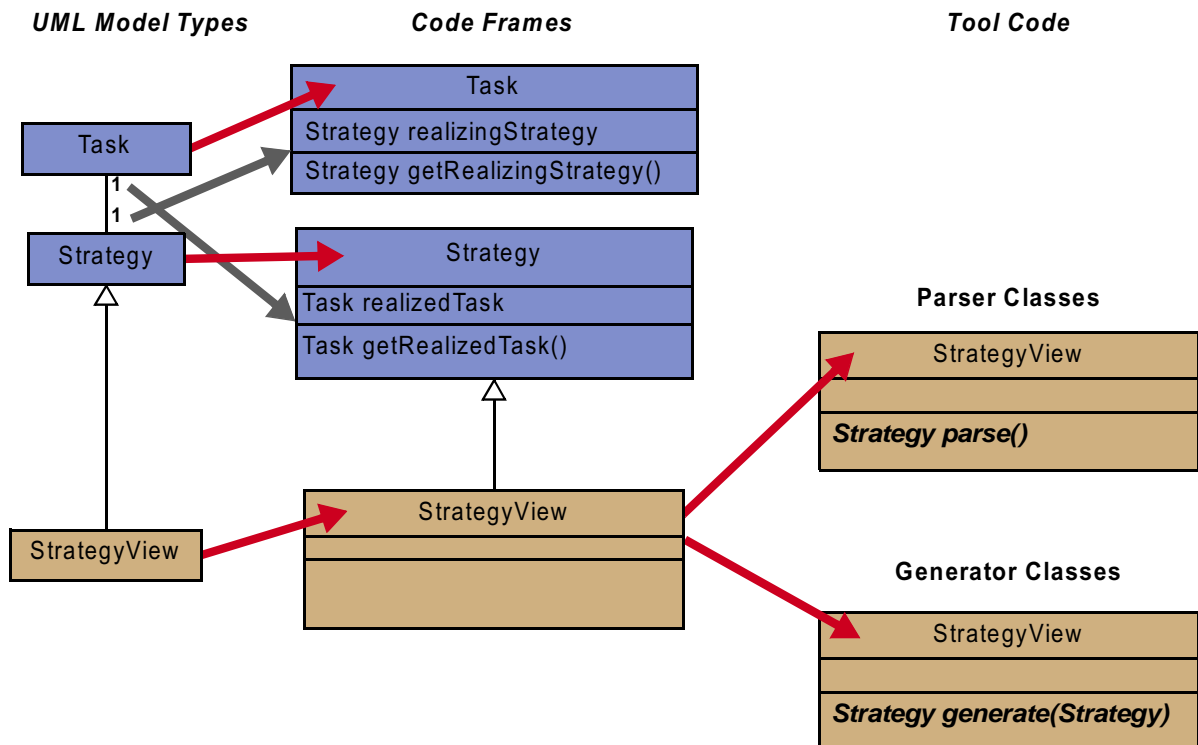

Andreas Metzger – International Colloquium of the SFB 501 – Kaiserslautern – March, 2003

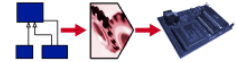

Base Classes

- common data repository for all tools
- allow interchange of instantiation information between tools
  - similar to UML model interchange (XMI)
  - **Marshalling:** instantiation information → file
  - **Unmarshalling:** file → instantiation of classes
  - file format: SLANG (similar to XML)

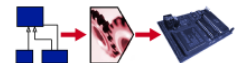
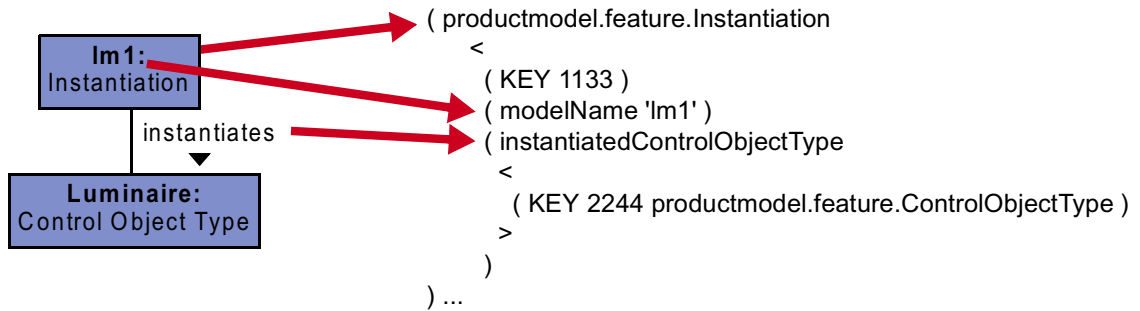

Tool Specific Classes

- problem: cannot use Java inheritance for extending model classes

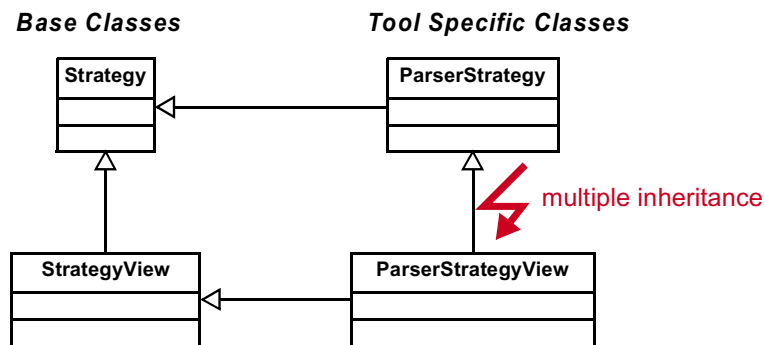

- solution: separation in model and user files + merging
  - **model files** contain code of base classes (**code frames**)
  - **user files** contain tool specific code extensions (e.g. parse() method) (**code extensions**)
  - **merged files** contain tool specific classes (**tool code**)
- merged files are always of the base type