

# Calculus of Variations

Lecture Notes

Erich Miersemann  
Department of Mathematics  
Leipzig University

Version October, 2012



# Contents

<b>1</b>	<b>Introduction</b>	<b>9</b>
1.1	Problems in $\mathbb{R}^n$	9
1.1.1	Calculus	9
1.1.2	Nash equilibrium	10
1.1.3	Eigenvalues	10
1.2	Ordinary differential equations	11
1.2.1	Rotationally symmetric minimal surface	12
1.2.2	Brachistochrone	13
1.2.3	Geodesic curves	14
1.2.4	Critical load	15
1.2.5	Euler's polygonal method	20
1.2.6	Optimal control	21
1.3	Partial differential equations	22
1.3.1	Dirichlet integral	22
1.3.2	Minimal surface equation	23
1.3.3	Capillary equation	26
1.3.4	Liquid layers	29
1.3.5	Extremal property of an eigenvalue	30
1.3.6	Isoperimetric problems	31
1.4	Exercises	33
<b>2</b>	<b>Functions of n variables</b>	<b>39</b>
2.1	Optima, tangent cones	39
2.1.1	Exercises	45
2.2	Necessary conditions	47
2.2.1	Equality constraints	49
2.2.2	Inequality constraints	52
2.2.3	Supplement	56
2.2.4	Exercises	58

2.3	Sufficient conditions . . . . .	59
2.3.1	Equality constraints . . . . .	61
2.3.2	Inequality constraints . . . . .	62
2.3.3	Exercises . . . . .	64
2.4	Kuhn-Tucker theory . . . . .	65
2.4.1	Exercises . . . . .	71
2.5	Examples . . . . .	72
2.5.1	Maximizing of utility . . . . .	72
2.5.2	$V$ is a polyhedron . . . . .	73
2.5.3	Eigenvalue equations . . . . .	73
2.5.4	Unilateral eigenvalue problems . . . . .	77
2.5.5	Noncooperative games . . . . .	79
2.5.6	Exercises . . . . .	83
2.6	Appendix: Convex sets . . . . .	90
2.6.1	Separation of convex sets . . . . .	90
2.6.2	Linear inequalities . . . . .	94
2.6.3	Projection on convex sets . . . . .	96
2.6.4	Lagrange multiplier rules . . . . .	98
2.6.5	Exercises . . . . .	101
2.7	References . . . . .	103
<b>3</b>	<b>Ordinary differential equations</b>	<b>105</b>
3.1	Optima, tangent cones, derivatives . . . . .	105
3.1.1	Exercises . . . . .	108
3.2	Necessary conditions . . . . .	109
3.2.1	Free problems . . . . .	109
3.2.2	Systems of equations . . . . .	120
3.2.3	Free boundary conditions . . . . .	123
3.2.4	Transversality conditions . . . . .	125
3.2.5	Nonsmooth solutions . . . . .	129
3.2.6	Equality constraints; functionals . . . . .	134
3.2.7	Equality constraints; functions . . . . .	137
3.2.8	Unilateral constraints . . . . .	141
3.2.9	Exercises . . . . .	145
3.3	Sufficient conditions; weak minimizers . . . . .	149
3.3.1	Free problems . . . . .	149
3.3.2	Equality constraints . . . . .	152
3.3.3	Unilateral constraints . . . . .	155
3.3.4	Exercises . . . . .	162
3.4	Sufficient condition; strong minimizers . . . . .	164

3.4.1	Exercises . . . . .	169
3.5	Optimal control . . . . .	170
3.5.1	Pontryagin's maximum principle . . . . .	171
3.5.2	Examples . . . . .	171
3.5.3	Proof of Pontryagin's maximum principle; free endpoint	176
3.5.4	Proof of Pontryagin's maximum principle; fixed end- point . . . . .	179
3.5.5	Exercises . . . . .	185



# Preface

These lecture notes are intended as a straightforward introduction to the calculus of variations which can serve as a textbook for undergraduate and beginning graduate students.

The main body of Chapter 2 consists of well known results concerning necessary or sufficient criteria for local minimizers, including Lagrange multiplier rules, of real functions defined on a Euclidean  $n$ -space. Chapter 3 concerns problems governed by ordinary differential equations.

The content of these notes is not encyclopedic at all. For additional reading we recommend following books: Luenberger [36], Rockafellar [50] and Rockafellar and Wets [49] for Chapter 2 and Bolza [6], Courant and Hilbert [9], Giaquinta and Hildebrandt [19], Jost and Li-Jost [26], Sagan [52], Troutman [59] and Zeidler [60] for Chapter 3. Concerning variational problems governed by partial differential equations see Jost and Li-Jost [26] and Struwe [57], for example.





# Chapter 1

## Introduction

A huge amount of problems in the calculus of variations have their origin in physics where one has to minimize the energy associated to the problem under consideration. Nowadays many problems come from economics. Here is the main point that the resources are restricted. There is no economy without restricted resources.

Some basic problems in the calculus of variations are:

- (i) find minimizers,
- (ii) necessary conditions which have to satisfy minimizers,
- (iii) find solutions (extremals) which satisfy the necessary condition,
- (iv) sufficient conditions which guarantee that such solutions are minimizers,
- (v) qualitative properties of minimizers, like regularity properties,
- (vi) how depend minimizers on parameters?,
- (vii) stability of extremals depending on parameters.

In the following we consider some examples.

### 1.1 Problems in $\mathbb{R}^n$

#### 1.1.1 Calculus

Let  $f : V \mapsto \mathbb{R}$ , where  $V \subset \mathbb{R}^n$  is a nonempty set. Consider the problem

$$x \in V : f(x) \leq f(y) \text{ for all } y \in V.$$

If there exists a solution then it follows further characterizations of the solution which allow in many cases to calculate this solution. The main tool

for obtaining further properties is to insert for  $y$  *admissible variations* of  $x$ .

As an example let  $V$  be a convex set. Then for given  $y \in V$

$$f(x) \leq f(x + \epsilon(y - x))$$

for all real  $0 \leq \epsilon \leq 1$ . From this inequality one derives the inequality

$$\langle \nabla f(x), y - x \rangle \geq 0 \quad \text{for all } y \in V,$$

provided that  $f \in C^1(\mathbb{R}^n)$ .

### 1.1.2 Nash equilibrium

In generalization to the above problem we consider two real functions  $f_i(x, y)$ ,  $i = 1, 2$ , defined on  $S_1 \times S_2$ , where  $S_i \subset \mathbb{R}^{m_i}$ . An  $(x^*, y^*) \in S_1 \times S_2$  is called a *Nash equilibrium* if

$$\begin{aligned} f_1(x, y^*) &\leq f_1(x^*, y^*) \quad \text{for all } x \in S_1 \\ f_2(x^*, y) &\leq f_2(x^*, y^*) \quad \text{for all } y \in S_2. \end{aligned}$$

The functions  $f_1, f_2$  are called *payoff functions* of two players and the sets  $S_1$  and  $S_2$  are the *strategy sets* of the players. Under additional assumptions on  $f_i$  and  $S_i$  there exists a Nash equilibrium, see Nash [46]. In Section 2.4.5 we consider more general problems of noncooperative games which play an important role in economics, for example.

### 1.1.3 Eigenvalues

Consider the eigenvalue problem

$$Ax = \lambda Bx,$$

where  $A$  and  $B$  are real and symmetric matrices with  $n$  rows (and  $n$  columns). Suppose that  $\langle By, y \rangle > 0$  for all  $y \in \mathbb{R}^n \setminus \{0\}$ , then the lowest eigenvalue  $\lambda_1$  is given by

$$\lambda_1 = \min_{y \in \mathbb{R}^n \setminus \{0\}} \frac{\langle Ay, y \rangle}{\langle By, y \rangle}.$$

The higher eigenvalues can be characterized by the maximum-minimum principle of Courant, see Section 2.5.

In generalization, let  $C \subset \mathbb{R}^n$  be a nonempty closed convex cone with vertex at the origin. Assume  $C \neq \{0\}$ . Then, see [37],

$$\lambda_1 = \min_{y \in C \setminus \{0\}} \frac{\langle Ay, y \rangle}{\langle By, y \rangle}$$

is the lowest eigenvalue of the variational inequality

$$x \in C : \langle Ax, y - x \rangle \geq \lambda \langle Bx, y - x \rangle \text{ for all } y \in C.$$

**Remark.** A set  $C \subset \mathbb{R}^n$  is said to be a *cone with vertex at  $x$*  if for any  $y \in C$  it follows that  $x + t(y - x) \in C$  for all  $t > 0$ .

## 1.2 Ordinary differential equations

Set

$$E(v) = \int_a^b f(x, v(x), v'(x)) dx$$

and for given  $u_a, u_b \in \mathbb{R}$

$$V = \{v \in C^1[a, b] : v(a) = u_a, v(b) = u_b\},$$

where  $-\infty < a < b < \infty$  and  $f$  is sufficiently regular. One of the basic problems in the calculus of variation is

$$(P) \quad \min_{v \in V} E(v).$$

That is, we seek a

$$u \in V : E(u) \leq E(v) \text{ for all } v \in V.$$

**Euler equation.** Let  $u \in V$  be a solution of (P) and assume additionally  $u \in C^2(a, b)$ , then

$$\frac{d}{dx} f_{u'}(x, u(x), u'(x)) = f_u(x, u(x), u'(x))$$

in  $(a, b)$ .

*Proof.* Exercise. Hints: For fixed  $\phi \in C^2[a, b]$  with  $\phi(a) = \phi(b) = 0$  and real  $\epsilon$ ,  $|\epsilon| < \epsilon_0$ , set  $g(\epsilon) = E(u + \epsilon\phi)$ . Since  $g(0) \leq g(\epsilon)$  it follows  $g'(0) = 0$ . Integration by parts in the formula for  $g'(0)$  and the following basic lemma in the calculus of variations imply Euler's equation.  $\square$

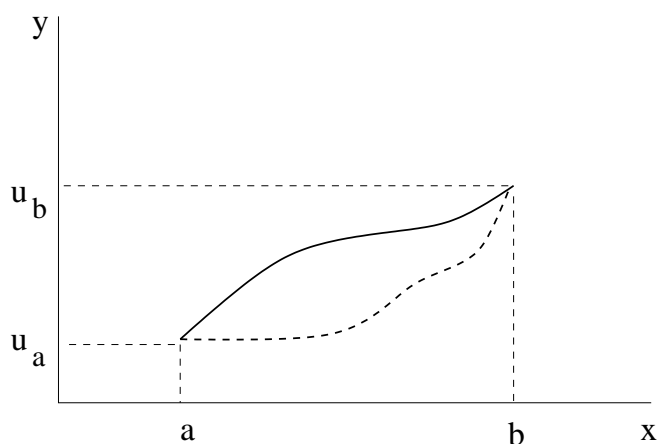

Figure 1.1: Admissible variations

**Basic lemma in the calculus of variations.** Let  $h \in C(a, b)$  and

$$\int_a^b h(x)\phi(x) dx = 0$$

for all  $\phi \in C_0^1(a, b)$ . Then  $h(x) \equiv 0$  on  $(a, b)$ .

*Proof.* Assume  $h(x_0) > 0$  for an  $x_0 \in (a, b)$ , then there is a  $\delta > 0$  such that  $(x_0 - \delta, x_0 + \delta) \subset (a, b)$  and  $h(x) \geq h(x_0)/2$  on  $(x_0 - \delta, x_0 + \delta)$ . Set

$$\phi(x) = \begin{cases} (\delta^2 - |x - x_0|^2)^2 & \text{if } x \in (x_0 - \delta, x_0 + \delta) \\ 0 & \text{if } x \in (a, b) \setminus [x_0 - \delta, x_0 + \delta] \end{cases}.$$

Thus  $\phi \in C_0^1(a, b)$  and

$$\int_a^b h(x)\phi(x) dx \geq \frac{h(x_0)}{2} \int_{x_0 - \delta}^{x_0 + \delta} \phi(x) dx > 0,$$

which is a contradiction to the assumption of the lemma.  $\square$

### 1.2.1 Rotationally symmetric minimal surface

Consider a curve defined by  $v(x)$ ,  $0 \leq x \leq l$ , which satisfies  $v(x) > 0$  on  $[0, l]$  and  $v(0) = a$ ,  $v(l) = b$  for given positive  $a$  and  $b$ , see Figure 1.2. Let  $\mathcal{S}(v)$

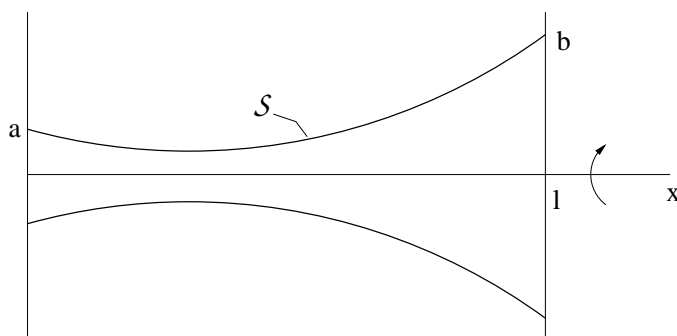

Figure 1.2: Rotationally symmetric surface

be the surface defined by rotating the curve around the  $x$ -axis. The area of this surface is

$$|\mathcal{S}(v)| = 2\pi \int_0^l v(x) \sqrt{1 + (v'(x))^2} dx.$$

Set

$$V = \{v \in C^1[0, l] : v(0) = a, v(l) = b, v(x) > 0 \text{ on } (a, b)\}.$$

Then the variational problem which we have to consider is

$$\min_{v \in V} |\mathcal{S}(v)|.$$

Solutions of the associated Euler equation are catenoids (= chain curves), see an exercise.

### 1.2.2 Brachistochrone

In 1696 Johann Bernoulli studied the problem of a brachistochrone to find a curve connecting two points  $P_1$  and  $P_2$  such that a mass point moves from  $P_1$  to  $P_2$  as fast as possible in a downward directed constant gravitational field, see Figure 1.3. The associated variational problem is here

$$\min_{(x,y) \in V} \int_{t_1}^{t_2} \frac{\sqrt{x'(t)^2 + y'(t)^2}}{\sqrt{y(t) - y_1 + k}} dt,$$

where  $V$  is the set of  $C^1[t_1, t_2]$  curves defined by  $(x(t), y(t))$ ,  $t_1 \leq t \leq t_2$ , with  $x'(t)^2 + y'(t)^2 \neq 0$ ,  $(x(t_1), y(t_1)) = P_1$ ,  $(x(t_2), y(t_2)) = P_2$  and  $k := v_1^2/2g$ , where  $v_1$  is the absolute value of the initial velocity of the mass point, and  $y_1 := y(t_1)$ . Solutions are cycloids (German: Rollkurven), see Bolza [6]

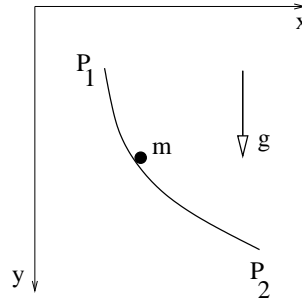

Figure 1.3: Problem of a brachistochrone

and Chapter 3. These functions are solutions of the system of the Euler differential equations associated to the above variational problem.

One arrives at the above functional which we have to minimize since

$$v = \sqrt{2g(y - y_1) + v_1^2}, \quad v = ds/dt, \quad ds = \sqrt{x_1(t)^2 + y'(t)^2} dt$$

and

$$T = \int_{t_1}^{t_2} dt = \int_{t_1}^{t_2} \frac{ds}{v},$$

where  $T$  is the time which the mass point needs to move from  $P_1$  to  $P_2$ .

### 1.2.3 Geodesic curves

Consider a surface  $\mathcal{S}$  in  $\mathbb{R}^3$ , two points  $P_1, P_2$  on  $\mathcal{S}$  and a curve on  $\mathcal{S}$  connecting these points, see Figure 1.4. Suppose that the surface  $\mathcal{S}$  is defined by  $x = x(v)$ , where  $x = (x_1, x_2, x_3)$  and  $v = (v_1, v_2)$  and  $v \in U \subset \mathbb{R}^2$ . Consider curves  $v(t)$ ,  $t_1 \leq t \leq t_2$ , in  $U$  such that  $v \in C^1[t_1, t_2]$  and  $v'_1(t)^2 + v'_2(t)^2 \neq 0$  on  $[t_1, t_2]$ , and define

$$V = \{v \in C^1[t_1, t_2] : x(v(t_1)) = P_1, x(v(t_2)) = P_2\}.$$

The length of a curve  $x(v(t))$  for  $v \in V$  is given by

$$L(v) = \int_{t_1}^{t_2} \sqrt{\frac{dx(v(t))}{dt} \cdot \frac{dx(v(t))}{dt}} dt.$$

Set  $E = x_{v_1} \cdot x_{v_1}$ ,  $F = x_{v_1} \cdot x_{v_2}$ ,  $G = x_{v_2} \cdot x_{v_2}$ . The functions  $E$ ,  $F$  and  $G$  are called coefficients of the first fundamental form of Gauss. Then we get for the length of the curve under consideration

$$L(v) = \int_{t_1}^{t_2} \sqrt{E(v(t))v'_1(t)^2 + 2F(v(t))v'_1(t)v'_2(t) + G(v(t))v'_2(t)^2} dt$$

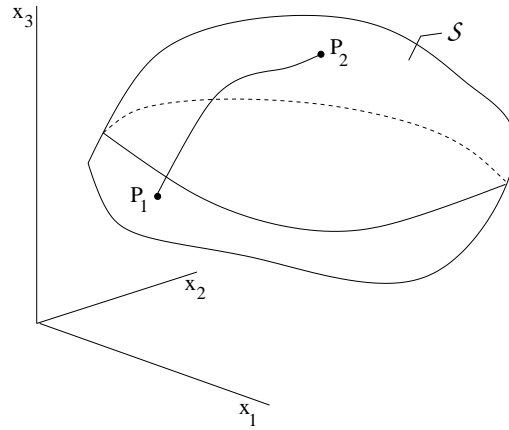

Figure 1.4: Geodesic curves

and the associated variational problem to study is here

$$\min_{v \in V} L(v).$$

For examples of surfaces (sphere, ellipsoid) see [9], Part II.

#### 1.2.4 Critical load

Consider the problem of the critical Euler load  $P$  for a beam. This value is given by

$$P = \min_{V \setminus \{0\}} \frac{a(v, v)}{b(v, v)},$$

where

$$\begin{aligned} a(u, v) &= EI \int_0^l u''(x)v''(x) dx \\ b(u, v) &= \int_0^2 u'(x)v'(x) dx \end{aligned}$$

and

$E$  modulus of elasticity,

$I$  surface moment of inertia,  $EI$  is called *bending stiffness*,

$V$  is the set of admissible deflections defined by the prescribed conditions at the ends of the beam. In the case of a beam simply supported at both ends, see Figure 1.5(a), we have

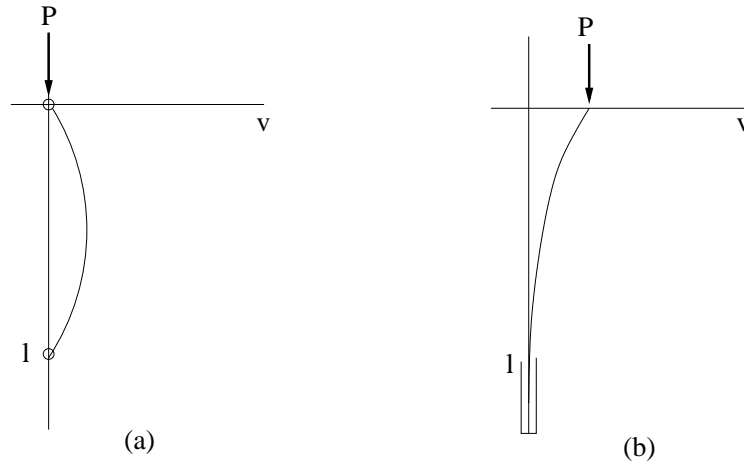

Figure 1.5: Euler load of a beam

$$V = \{v \in C^2[0, l] : v(0) = v(l) = 0\}$$

which leads to the critical value  $P = EI\pi^2/l^2$ . If the beam is clamped at the lower end and free (no condition is prescribed) at the upper end, see Figure 1.5(b), then

$$V = \{v \in C^2[0, l] : v(0) = v'(0) = 0\},$$

and the critical load is here  $P = EI\pi^2/(4l^2)$ .

**Remark.** The quotient  $a(v, v)/b(v, v)$  is called *Rayleigh quotient* (Lord Rayleigh, 1842-1919).

Example: **Summer house**

As an example we consider a summer house based on columns, see Figure 1.6:

9 columns of pine wood, clamped at the lower end, free at the upper end,

9 cm  $\times$  9 cm is the cross section of each column,

2,5 m length of a column,

$9 \cdot 16 \cdot 10^9 \text{ Nm}^{-2}$  modulus of elasticity, parallel fiber,

$0.6 \cdot 1 \cdot 10^9 \text{ Nm}^{-2}$  modulus of elasticity, perpendicular fiber,

$$I = \int \int_{\Omega} x^2 dx dy, \quad \Omega = (-4.5, 4.5) \times (-4.5, 4.5),$$



$$I = 546.75 \cdot 10^{-8} m^4,$$

$$E := 5 \times 10^9 Nm^{-2},$$

$$P=10792 \text{ N, } m=1100 \text{ kg (g:=9.80665 } ms^{-2}),$$

9 columns: 9900 kg,  
 18  $m^2$  area of the flat roof,  
 10 cm wetted snow: 1800 kg.



Figure 1.6: Summer house construction

### Unilateral buckling

If there are obstacles on both sides, see Figure 1.7, then we have in the case of a beam simply supported at both ends

$$V = \{v \in C^2[0, l] : v(0) = v(l) = 0 \text{ and } \phi_1(x) \leq v(x) \leq \phi_2(x) \text{ on } (0, l)\}.$$

The critical load is here

$$P = \inf_{V \setminus \{0\}} \frac{a(v, v)}{b(v, v)}.$$

It can be shown, see [37, 38], that this number  $P$  is the lowest point of bifurcation of the eigenvalue variational inequality

$$u \in V : a(u, v - u) \geq \lambda b(u, v - u) \text{ for all } v \in V.$$

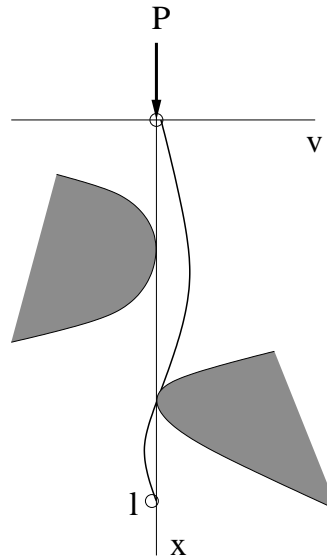

Figure 1.7: Unilateral beam

A real  $\lambda_0$  is said to be a *point of bifurcation* of the the above inequality if there exists a sequence  $u_n$ ,  $u_n \neq 0$ , of solutions with associated eigenvalues  $\lambda_n$  such that  $u_n \rightarrow 0$  uniformly on  $[0, l]$  and  $\lambda_n \rightarrow \lambda_0$ .

### Optimal design of a column

Consider a rotationally symmetric column, see Figure 1.8. Let

$l$  be the length of the column,

$r(x)$  radius of the cross section,

$I(x) = \pi(r(x))^4/4$  surface moment of inertia,

$\rho$  constant density of the material,

$E$  modulus of elasticity.

Set

$$a(r)(u, v) = \int_0^l r(x)^4 u''(x) v''(x) dx - \frac{4\rho}{E} \int_0^l \left( \int_x^l r(t)^2 dt \right) u'(x) v'(x) dx$$

$$b(r)(v, v) = \int_0^l u'(x) v'(x) dx.$$

Suppose that  $\rho/E$  is sufficiently small to avoid that the column is unstable without any load  $P$ . If the column is clamped at the lower end and free at

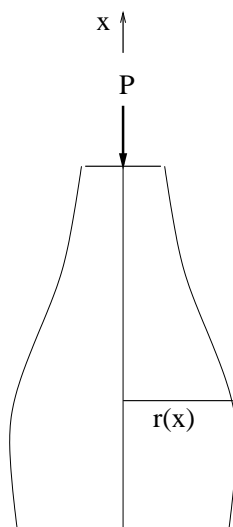

Figure 1.8: Optimal design of a column

the upper end, then we set

$$V = \{v \in C^2[0, l] : v(0) = v'(0) = 0\}$$

and consider the Rayleigh quotient

$$q(r, v) = \frac{a(r)(v, v)}{b(r)(v, v)}.$$

We seek an  $r$  such that the critical load  $P(r) = E\pi\lambda(r)/4$ , where

$$\lambda(r) = \min_{v \in V \setminus \{0\}} q(r, v),$$

approaches its infimum in a given set  $U$  of functions, for example

$$U = \{r \in C[a, b] : r_0 \leq r(x) \leq r_1, \pi \int_0^l r(x)^2 dx = M\},$$

where  $r_0, r_1$  are given positive constants and  $M$  is the given volume of the column. That is, we consider the *saddle point* problem

$$\max_{r \in U} \left( \min_{v \in V \setminus \{0\}} q(r, v) \right).$$

Let  $(r_0, v_0)$  be a solution, then

$$q(r, v_0) \leq q(r_0, v_0) \leq q(r_0, v)$$

for all  $r \in U$  and for all  $v \in V \setminus \{0\}$ .

### 1.2.5 Euler's polygonal method

Consider the functional

$$E(v) = \int_a^b f(x, v(x), v'(x)) dx,$$

where  $v \in V$  with

$$V = \{v \in C^1[a, b] : v(a) = A, v(b) = B\}$$

with given  $A, B$ . Let

$$a = x_0 < x_1 < \dots < x_n < x_{n+1} = b$$

be a subdivision of the interval  $[a, b]$ . Then we replace the graph defined by  $v(x)$  by the polygon defined by  $(x_0, A), (x_1, v_1), \dots, (x_n, v_n), (x_{n+1}, B)$ , where  $v_i = v(x_i)$ , see Figure 1.9. Set  $h_i = x_i - x_{i-1}$  and  $v = (v_1, \dots, v_n)$ ,

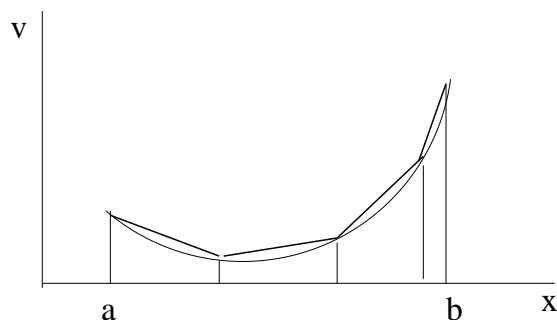

Figure 1.9: Polygonal method

and replace the above integral by

$$e(v) = \sum_{i=1}^{n+1} f\left(x_i, v_i, \frac{v_i - v_{i-1}}{h_i}\right) h_i.$$

The problem  $\min_{v \in \mathbb{R}^n} e(v)$  is an associated finite dimensional problem to  $\min_{v \in V} E(v)$ . Then one shows, under additional assumptions, that the finite dimensional problem has a solution which converges to a solution to the original problem if  $n \rightarrow \infty$ .

**Remark.** The historical notation "problems with infinitely many variables" for the above problem for the functional  $E(v)$  has its origin in Euler's polygonal method.

### 1.2.6 Optimal control

As an example for problems in optimal control theory we mention here a problem governed by ordinary differential equations. For a given function  $v(t) \in U \subset \mathbb{R}^m$ ,  $t_0 \leq t \leq t_1$ , we consider the boundary value problem

$$y'(t) = f(t, y(t), v(t)), \quad y(t_0) = x^0, \quad y(t_1) = x^1,$$

where  $y \in \mathbb{R}^n$ ,  $x^0, x^1$  are given, and

$$f : [t_0, t_1] \times \mathbb{R}^n \times \mathbb{R}^m \mapsto \mathbb{R}^n.$$

In general, there is no solution of such a problem. Therefore we consider the set of admissible controls  $U_{ad}$  defined by the set of piecewise continuous functions  $v$  on  $[t_0, t_1]$  such that there exists a solution of the boundary value problem. We suppose that this set is not empty. Assume a cost functional is given by

$$E(v) = \int_{t_0}^{t_1} f^0(t, y(t), v(t)) dt,$$

where

$$f^0 : [t_0, t_1] \times \mathbb{R}^n \times \mathbb{R}^m \mapsto \mathbb{R},$$

$v \in U_{ad}$  and  $y(t)$  is the solution of the above boundary value problem with the control  $v$ .

The functions  $f, f^0$  are assumed to be continuous in  $(t, y, v)$  and continuously differentiable in  $(t, y)$ . *It is not required that these functions are differentiable with respect to  $v$ .*

Then the problem of optimal control is

$$\max_{v \in U_{ad}} E(v).$$

A piecewise continuous solution  $u$  is called *optimal control* and the solution  $x$  of the associated system of boundary value problems is said to be *optimal trajectory*.

The governing necessary condition for this type of problems is the Pontryagin maximum principle, see [48] and Section 3.5.

### 1.3 Partial differential equations

The same procedure as above applied to the following multiple integral leads to a second-order quasilinear partial differential equation. Set

$$E(v) = \int_{\Omega} F(x, v, \nabla v) \, dx,$$

where  $\Omega \subset \mathbb{R}^n$  is a domain,  $x = (x_1, \dots, x_n)$ ,  $v = v(x) : \Omega \mapsto \mathbb{R}$ , and  $\nabla v = (v_{x_1}, \dots, v_{x_n})$ . It is assumed that the function  $F$  is sufficiently regular in its arguments. For a given function  $h$ , defined on  $\partial\Omega$ , set

$$V = \{v \in C^1(\overline{\Omega}) : v = h \text{ on } \partial\Omega\}.$$

**Euler equation.** Let  $u \in V$  be a solution of (P), and additionally  $u \in C^2(\Omega)$ , then

$$\sum_{i=1}^n \frac{\partial}{\partial x_i} F_{u_{x_i}} = F_u$$

in  $\Omega$ .

*Proof.* Exercise. Hint: Extend the above fundamental lemma of the calculus of variations to the case of multiple integrals. The interval  $(x_0 - \delta, x_0 + \delta)$  in the definition of  $\phi$  must be replaced by a ball with center at  $x_0$  and radius  $\delta$ .  $\square$

#### 1.3.1 Dirichlet integral

In two dimensions the Dirichlet integral is given by

$$D(v) = \int_{\Omega} (v_x^2 + v_y^2) \, dx dy$$

and the associated Euler equation is the Laplace equation  $\Delta u = 0$  in  $\Omega$ .

Thus, there is natural relationship between the boundary value problem

$$\Delta u = 0 \text{ in } \Omega, \quad u = h \text{ on } \partial\Omega$$

and the variational problem

$$\min_{v \in V} D(v).$$

But these problems are not equivalent in general. It can happen that the boundary value problem has a solution but the variational problem has no solution. For an example see Courant and Hilbert [9], Vol. 1, p. 155, where  $h$  is a continuous function and the associated solution  $u$  of the boundary value problem has no finite Dirichlet integral.

The problems are equivalent, provided the given boundary value function  $h$  is in the class  $H^{1/2}(\partial\Omega)$ , see Lions and Magenes [35].

### 1.3.2 Minimal surface equation

The non-parametric minimal surface problem in two dimensions is to find a minimizer  $u = u(x_1, x_2)$  of the problem

$$\min_{v \in V} \int_{\Omega} \sqrt{1 + v_{x_1}^2 + v_{x_2}^2} \, dx,$$

where for a given function  $h$  defined on the boundary of the domain  $\Omega$

$$V = \{v \in C^1(\bar{\Omega}) : v = h \text{ on } \partial\Omega\}.$$

Suppose that the minimizer satisfies the regularity assumption  $u \in C^2(\Omega)$ ,

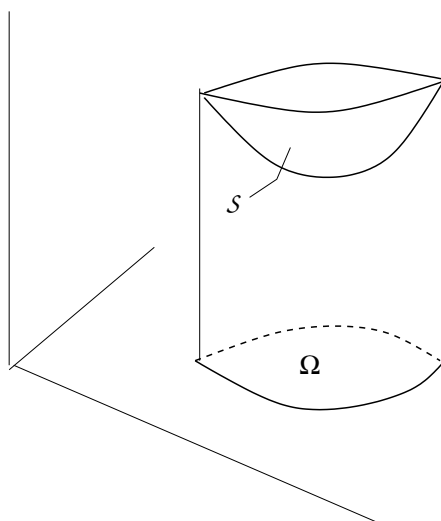

Figure 1.10: Comparison surface

then  $u$  is a solution of the *minimal surface equation* (Euler equation) in  $\Omega$

$$\frac{\partial}{\partial x_1} \left( \frac{u_{x_1}}{\sqrt{1 + |\nabla u|^2}} \right) + \frac{\partial}{\partial x_2} \left( \frac{u_{x_2}}{\sqrt{1 + |\nabla u|^2}} \right) = 0.$$

In fact, the additional assumption  $u \in C^2(\Omega)$  is superfluous since it follows from regularity considerations for quasilinear elliptic equations of second order, see for example Gilbarg and Trudinger [20].

Let  $\Omega = \mathbb{R}^2$ . Each linear function is a solution of the minimal surface equation. It was shown by Bernstein [4] that there are no other solutions of the minimal surface equation. This is true also for higher dimensions  $n \leq 7$ , see Simons [56]. If  $n \geq 8$ , then there exists also other solutions which define cones, see Bombieri, De Giorgi and Giusti [7].

The linearized minimal surface equation over  $u \equiv 0$  is the Laplace equation  $\Delta u = 0$ . In  $\mathbb{R}^2$  linear functions are solutions but also many other functions in contrast to the minimal surface equation. This striking difference is caused by the strong nonlinearity of the minimal surface equation.

More general minimal surfaces are described by using parametric representations. An example is shown in Figure 1.11<sup>1</sup>. See [52], pp. 62, for example, for rotationally symmetric minimal surfaces, and [47, 12, 13] for more general surfaces. Suppose that the surface  $\mathcal{S}$  is defined by  $y = y(v)$ ,



Figure 1.11: Rotationally symmetric minimal surface

where  $y = (y_1, y_2, y_3)$  and  $v = (v_1, v_2)$  and  $v \in U \subset \mathbb{R}^2$ . The area of the surface  $\mathcal{S}$  is given by

$$|\mathcal{S}(y)| = \int_U \sqrt{EG - F^2} \, dv,$$

<sup>1</sup>An experiment from Beutelspacher's Mathematikum, Wissenschaftsjahr 2008, Leipzig



where  $E = y_{v_1} \cdot y_{v_1}$ ,  $F = y_{v_1} \cdot y_{v_2}$ ,  $G = y_{v_2} \cdot y_{v_2}$  are the coefficients of the first fundamental form of Gauss. Then an associated variational problem is

$$\min_{y \in V} |\mathcal{S}(y)|,$$

where  $V$  is a given set of comparison surfaces which is defined, for example, by the condition that  $y(\partial U) \subset \Gamma$ , where  $\Gamma$  is a given curve in  $\mathbb{R}^3$ , see Figure 1.12. Set  $V = C^1(\bar{\Omega})$  and

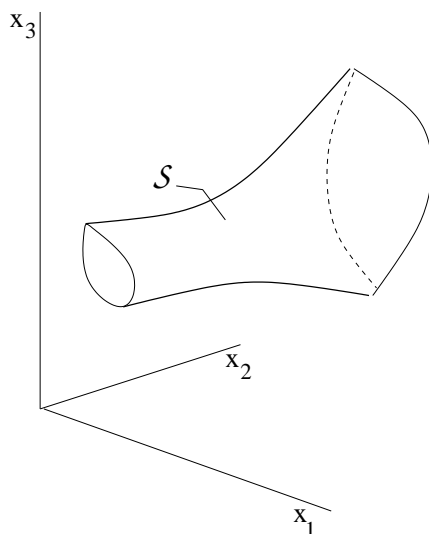

Figure 1.12: Minimal surface spanned between two rings

$$E(v) = \int_{\Omega} F(x, v, \nabla v) dx - \int_{\partial\Omega} g(x, v) ds,$$

where  $F$  and  $g$  are given sufficiently regular functions and  $\Omega \subset \mathbb{R}^n$  is a bounded and sufficiently regular domain. Assume  $u$  is a minimizer of  $E(v)$  in  $V$ , that is,

$$u \in V : E(u) \leq E(v) \text{ for all } v \in V,$$

then

$$\int_{\Omega} \left( \sum_{i=1}^n F_{u_{x_i}}(x, u, \nabla u) \phi_{x_i} + F_u(x, u, \nabla u) \phi \right) dx - \int_{\partial\Omega} g_u(x, u) \phi ds = 0$$

for all  $\phi \in C^1(\overline{\Omega})$ . Assume additionally that  $u \in C^2(\Omega)$ , then  $u$  is a solution of the Neumann type boundary value problem

$$\begin{aligned} \sum_{i=1}^n \frac{\partial}{\partial x_i} F_{u_{x_i}} &= F_u \text{ in } \Omega \\ \sum_{i=1}^n F_{u_{x_i}} \nu_i &= g_u \text{ on } \partial\Omega, \end{aligned}$$

where  $\nu = (\nu_1, \dots, \nu_n)$  is the exterior unit normal at the boundary  $\partial\Omega$ . This follows after integration by parts from the basic lemma of the calculus of variations.

Set

$$E(v) = \frac{1}{2} \int_{\Omega} |\nabla v|^2 dx - \int_{\partial\Omega} h(x)v ds,$$

then the associated boundary value problem is

$$\begin{aligned} \Delta u &= 0 \text{ in } \Omega \\ \frac{\partial u}{\partial \nu} &= h \text{ on } \partial\Omega. \end{aligned}$$

### 1.3.3 Capillary equation

Let  $\Omega \subset \mathbb{R}^2$  and set

$$E(v) = \int_{\Omega} \sqrt{1 + |\nabla v|^2} dx + \frac{\kappa}{2} \int_{\Omega} v^2 dx - \cos \gamma \int_{\partial\Omega} v ds.$$

Here is  $\kappa$  a positive constant (capillarity constant) and  $\gamma$  is the (constant) boundary contact angle, that is, the angle between the container wall and the capillary surface, defined by  $v = v(x_1, x_2)$ , at the boundary. Then the related boundary value problem is

$$\begin{aligned} \operatorname{div}(Tu) &= \kappa u \text{ in } \Omega \\ \nu \cdot Tu &= \cos \gamma \text{ on } \partial\Omega, \end{aligned}$$

where we use the abbreviation

$$Tu = \frac{\nabla u}{\sqrt{1 + |\nabla u|^2}},$$

$\operatorname{div}(Tu)$  is the left hand side of the minimal surface equation and it is twice the mean curvature of the surface defined by  $z = u(x_1, x_2)$ , see an exercise.

The above problem describes the ascent of a liquid, water for example, in a vertical cylinder with constant cross section  $\Omega$ . It is assumed that the gravity is directed downwards in the direction of the negative  $x_3$  axis. Figure 1.13 shows that liquid can rise along a vertical wedge. This is a consequence of the strong nonlinearity of the underlying equations, see Finn [16]. This photo was taken from [42].

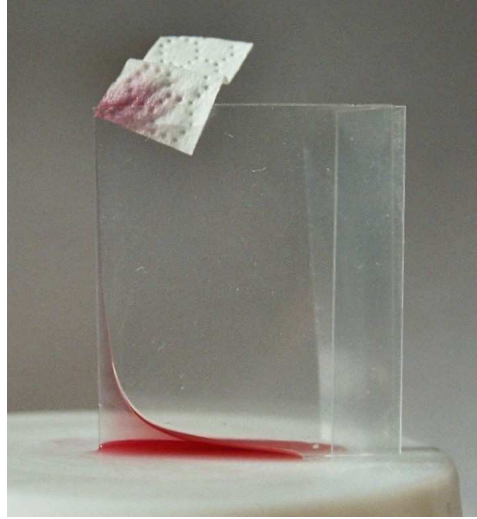

Figure 1.13: Ascent of liquid in a wedge

The above problem is a special case (graph solution) of the following problem. Consider a container partially filled with a liquid, see Figure 1.14. Suppose that the associate energy functional is given by

$$E(\mathcal{S}) = \sigma|\mathcal{S}| - \sigma\beta|W(\mathcal{S})| + \int_{\Omega_l(\mathcal{S})} Y\rho \, dx,$$

where

$Y$  potential energy per unit mass, for example  $Y = gx_3$ ,  $g = \text{const.} \geq 0$ ,

$\rho$  local density,

$\sigma$  surface tension,  $\sigma = \text{const.} > 0$ ,

$\beta$  (relative) adhesion coefficient between the fluid and the container wall,

$W$  wetted part of the container wall,

$\Omega_l$  domain occupied by the liquid.

Additionally we have for given volume  $V$  of the liquid the constraint

$$|\Omega_l(\mathcal{S})| = V.$$

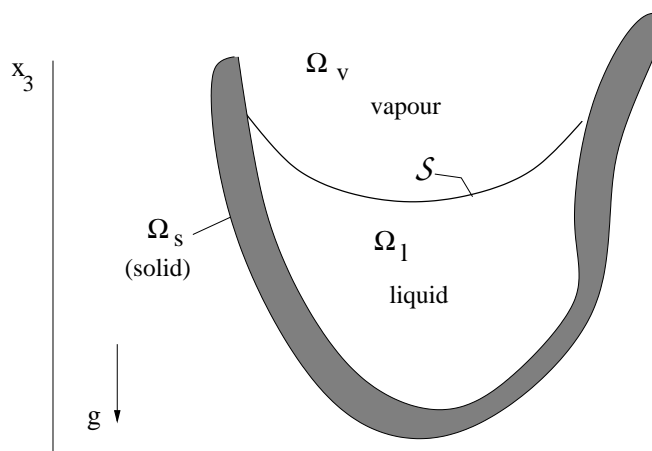

Figure 1.14: Liquid in a container

It turns out that a minimizer  $\mathcal{S}_0$  of the energy functional under the volume constraint satisfies, see [16],

$$\begin{aligned} 2\sigma H &= \lambda + g\rho x_3 \text{ on } \mathcal{S}_0 \\ \cos \gamma &= \beta \text{ on } \partial\mathcal{S}_0, \end{aligned}$$

where  $H$  is the mean curvature of  $\mathcal{S}_0$  and  $\gamma$  is the angle between the surface  $\mathcal{S}_0$  and the container wall at  $\partial\mathcal{S}_0$ .

**Remark.** The term  $-\sigma\beta|W|$  in the above energy functional is called *wetting energy*.

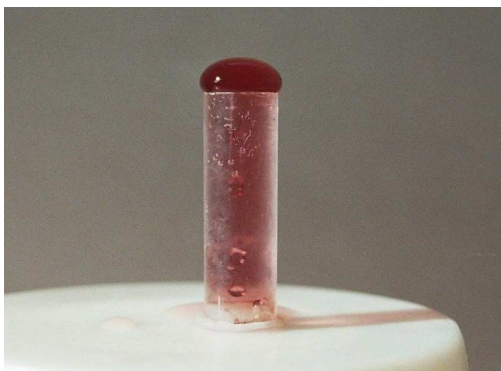

Figure 1.15: Piled up of liquid

Liquid can be pulled up on a glass, see Figure 1.15. This picture was taken from [42]. Here the capillary surface  $\mathcal{S}$  satisfies a variational inequality at  $\partial\mathcal{S}$  where  $\mathcal{S}$  meets the container wall along an edge, see [41].

### 1.3.4 Liquid layers

Porous materials have a large amount of cavities different in size and geometry. Such materials swell and shrink in dependence on air humidity. Here we consider an isolated cavity, see [54] for some cavities of special geometry.

Let  $\Omega_s \in \mathbb{R}^3$  be a domain occupied by homogeneous solid material. The question is whether or not liquid layers  $\Omega_l$  on  $\Omega_s$  are stable, where  $\Omega_v$  is the domain filled with vapour and  $\mathcal{S}$  is the capillary surface which is the interface between liquid and vapour, see Figure 1.16.

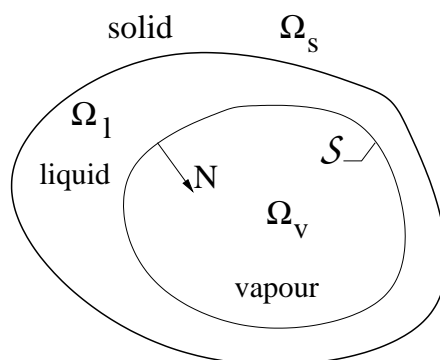

Figure 1.16: Liquid layer in a pore

Let

$$E(\mathcal{S}) = \sigma|\mathcal{S}| + w(\mathcal{S}) - \mu|D_l(\mathcal{S})| \quad (1.1)$$

be the energy (grand canonical potential) of the problem, where  $\sigma$  surface tension,  $|\mathcal{S}|$ ,  $|\Omega_l(\mathcal{S})|$  denote the area resp. volume of  $\mathcal{S}$ ,  $\Omega_l(\mathcal{S})$ ,

$$w(\mathcal{S}) = - \int_{\Omega_v(\mathcal{S})} F(x) dx, \quad (1.2)$$

is the disjoining pressure potential, where

$$F(x) = c \int_{\Omega_s} \frac{dy}{|x-y|^p}. \quad (1.3)$$

Here is  $c$  a *negative* constant,  $p > 4$  a positive constant ( $p = 6$  for nitrogen) and  $x \in \mathbb{R}^3 \setminus \overline{\Omega_s}$ , where  $\overline{\Omega_s}$  denotes the closure of  $\Omega_s$ , that is, the union of

$\Omega_s$  with its boundary  $\partial\Omega_s$ . Finally, set

$$\mu = \rho kT \ln(X) ,$$

where

$\rho$  density of the liquid,

$k$  Boltzmann constant,

$T$  absolute temperature,

$X$  reduced (constant) vapour pressure,  $0 < X < 1$ .

More precisely,  $\rho$  is the difference between the number densities of the liquid and the vapour phase. However, since in most practical cases the vapour density is rather small,  $\rho$  can be replaced by the density of the liquid phase.

The above negative constant is given by  $c = \mathcal{H}/\pi^2$ , where  $\mathcal{H}$  is the Hamaker constant, see [25], p. 177. For a liquid nitrogen film on quartz one has about  $\mathcal{H} = -10^{-20} Nm$ .

Suppose that  $\mathcal{S}_0$  defines a local minimum of the energy functional, then

$$-2\sigma H + F - \mu = 0 \quad \text{on } \mathcal{S}_0 , \quad (1.4)$$

where  $H$  is the mean curvature of  $\mathcal{S}_0$ .

A surface  $\mathcal{S}_0$  which satisfies (1.4) is said to be an *equilibrium state*. An existing equilibrium state  $\mathcal{S}_0$  is said to be *stable* by definition if

$$\left[ \frac{d^2}{d\epsilon^2} E(\mathcal{S}(\epsilon)) \right]_{\epsilon=0} > 0$$

for all  $\zeta$  not identically zero, where  $\mathcal{S}(\epsilon)$  is an appropriate one-parameter family of comparison surfaces.

This inequality implies that

$$-2(2H^2 - K) + \frac{1}{\sigma} \frac{\partial F}{\partial \mathbf{N}} > 0 \quad \text{on } \mathcal{S}_0, \quad (1.5)$$

where  $K$  is the Gauss curvature of the capillary surface  $\mathcal{S}_0$ , see Blaschke [5], p. 58, for the definition of  $K$ .

### 1.3.5 Extremal property of an eigenvalue

Let  $\Omega \subset \mathbb{R}^2$  be a bounded and connected domain. Consider the eigenvalue problem

$$\begin{aligned} -\Delta u &= \lambda u \quad \text{in } \Omega \\ u &= 0 \quad \text{on } \partial\Omega. \end{aligned}$$

It is known that the lowest eigenvalue  $\lambda_1(\Omega)$  is positive, it is a simple eigenvalue and the associated eigenfunction has no zero in  $\Omega$ . Let  $V$  be a set of sufficiently regular domains  $\Omega$  with prescribed area  $|\Omega|$ . Then we consider the problem

$$\min_{\Omega \in V} \lambda_1(\Omega).$$

The solution of this problem is a disk  $B_R$ ,  $R = \sqrt{|\Omega|/\pi}$ , and the solution is uniquely determined.

### 1.3.6 Isoperimetric problems

Let  $V$  be a set of all sufficiently regular bounded and connected domains  $\Omega \subset \mathbb{R}^2$  with prescribed length  $|\partial\Omega|$  of the boundary. Then we consider the problem

$$\max_{\Omega \in V} |\Omega|.$$

The solution of this problem is a disk  $B_R$ ,  $R = |\partial\Omega|/(2\pi)$ , and the solution is uniquely determined. This result follows by Steiner's symmetrization, see [5], for example. From this method it follows that

$$|\partial\Omega|^2 - 4\pi|\Omega| > 0$$

if  $\Omega$  is a domain different from a disk.

**Remark.** Such an isoperimetric inequality follows also by using the inequality

$$\int_{\mathbb{R}^2} |u| \, dx \leq \frac{1}{4\pi} \int_{\mathbb{R}^2} |\nabla u|^2 \, dx$$

for all  $u \in C_0^1(\mathbb{R}^2)$ . After an appropriate definition of the integral on the right hand side this inequality holds for functions from the Sobolev space  $H_0^1(\Omega)$ , see [1], or from the class  $BV(\Omega)$ , which are the functions of bounded variation, see [15]. The set of characteristic functions for sufficiently regular domains is contained in  $BV(\Omega)$  and the square root of the integral of the right hand defines the perimeter of  $\Omega$ . Set

$$u = \chi_\Omega = \begin{cases} 1 & : x \in \Omega \\ 0 & : x \notin \Omega \end{cases}$$

then

$$|\Omega| \leq \frac{1}{4\pi} |\partial\Omega|^2.$$

The associated problem in  $\mathbb{R}^3$  is

$$\max_{\Omega \in V} |\Omega|,$$

where  $V$  is the set of all sufficiently regular bounded and connected domains  $\Omega \subset \mathbb{R}^3$  with prescribed perimeter  $|\partial\Omega|$ . The solution of this problem is a ball  $B_R$ ,  $R = \sqrt{|\partial\Omega|/(4\pi)}$ , and the solution is uniquely determined, see [5], for example, where it is shown that the isoperimetric inequality

$$|\partial\Omega|^3 - 36\pi|\Omega|^2 \geq 0$$

holds for all sufficiently regular  $\Omega$ , and equality holds only if  $\Omega$  is a ball.



## 1.4 Exercises

1. Let  $V \subset \mathbb{R}^n$  be nonempty, closed and bounded and  $f : V \mapsto \mathbb{R}$  lower semicontinuous on  $V$ . Show that there exists an  $x \in V$  such that  $f(x) \leq f(y)$  for all  $y \in V$ .

*Hint:*  $f : V \mapsto \mathbb{R}^n$  is called lower semicontinuous on  $V$  if for every sequence  $x^k \rightarrow x$ ,  $x^k, x \in V$ , it follows that

$$\liminf_{k \rightarrow \infty} f(x^k) \geq f(x).$$

2. Let  $V \subset \mathbb{R}^n$  be the closure of a convex domain and assume  $f : V \mapsto \mathbb{R}$  is in  $C^1(\mathbb{R}^n)$ . Suppose that  $x \in V$  satisfies  $f(x) \leq f(y)$  for all  $y \in V$ . Prove

- (i)  $\langle \nabla f(x), y - x \rangle \geq 0$  for all  $y \in V$ ,  
(ii)  $\nabla f(x) = 0$  if  $x$  is an interior point of  $V$ .

3. Let  $A$  and  $B$  be real and symmetric matrices with  $n$  rows (and  $n$  columns). Suppose that  $B$  is positive, i. e.,  $\langle By, y \rangle > 0$  for all  $y \in \mathbb{R}^n \setminus \{0\}$ .

- (i) Show that there exists a solution  $x$  of the problem

$$\min_{y \in \mathbb{R}^n \setminus \{0\}} \frac{\langle Ay, y \rangle}{\langle By, y \rangle}.$$

- (ii) Show that  $Ax = \lambda Bx$ , where  $\lambda = \langle Ax, x \rangle / \langle Bx, x \rangle$ .

*Hint:* (a) Show that there is a positive constant such that  $\langle By, y \rangle \geq c \langle y, y \rangle$  for all  $y \in \mathbb{R}^n$ .

- (b) Show that there exists a solution  $x$  of the problem  $\min_y \langle Ay, y \rangle$ , where  $\langle By, y \rangle = 1$ .

- (c) Consider the function

$$g(\epsilon) = \frac{\langle A(x + \epsilon y), x + \epsilon y \rangle}{\langle B(x + \epsilon y), x + \epsilon y \rangle},$$

where  $|\epsilon| < \epsilon_0$ ,  $\epsilon_0$  sufficiently small, and use that  $g(0) \leq g(\epsilon)$ .

4. Let  $A$  and  $B$  satisfy the assumption of the previous exercise. Let  $C$  be a closed convex nonempty cone in  $\mathbb{R}^n$  with vertex at the origin. Assume  $C \neq \{0\}$ .

- (i) Show that there exists a solution  $x$  of the problem

$$\min_{y \in C \setminus \{0\}} \frac{\langle Ay, y \rangle}{\langle By, y \rangle}.$$

(ii) Show that  $x$  is a solution of

$$x \in C : \langle Ax, y - x \rangle \geq \lambda \langle x, y - x \rangle \text{ for all } y \in C,$$

where  $\lambda = \langle Ax, x \rangle / \langle Bx, x \rangle$ .

*Hint:* To show (ii) consider for  $x, y \in C$  the function

$$g(\epsilon) = \frac{\langle A(x + \epsilon(y - x)), x + \epsilon(y - x) \rangle}{\langle B(x + \epsilon(y - x)), x + \epsilon(y - x) \rangle},$$

where  $0 < \epsilon < \epsilon_0$ ,  $\epsilon_0$  sufficiently small, and use  $g(0) \leq g(\epsilon)$  which implies that  $g'(0) \geq 0$ .

5. Let  $A$  be real matrix with  $n$  rows and  $n$  columns, and let  $C \subset \mathbb{R}^n$  be a nonempty closed and convex cone with vertex at the origin. Show that

$$x \in C : \langle Ax, y - x \rangle \geq 0 \text{ for all } y \in C$$

is equivalent to

$$\langle Ax, x \rangle = 0 \text{ and } \langle Ax, y \rangle \geq 0 \text{ for all } y \in C.$$

*Hint:*  $2x, x + y \in C$  if  $x, y \in C$ .

6. R. Courant. Show that

$$E(v) := \int_0^1 (1 + (v'(x))^2)^{1/4} dx$$

does not achieve its infimum in the class of functions

$$V = \{v \in C[0, 1] : v \text{ piecewise } C^1, v(0) = 1, v(1) = 0\},$$

i. e., there is no  $u \in V$  such that  $E(u) \leq E(v)$  for all  $v \in V$ .

*Hint:* Consider the family of functions

$$v(\epsilon; x) = \begin{cases} (\epsilon - x)/\epsilon & : 0 \leq x \leq \epsilon < 1 \\ 0 & : x > \epsilon \end{cases}$$

7. K. Weierstraß, 1895. Show that

$$E(v) = \int_{-1}^1 x^2 (v'(x))^2 dx$$

does not achieve its infimum in the class of functions

$$V = \{v \in C^1[-1, 1] : v(-1) = a, v(1) = b\},$$

where  $a \neq b$ .

*Hint:*

$$v(x; \epsilon) = \frac{a+b}{2} + \frac{b-a}{2} \frac{\arctan(x/\epsilon)}{\arctan(1/\epsilon)}$$

defines a minimal sequence, i. e.,  $\lim_{\epsilon \rightarrow 0} E(v(\epsilon)) = \inf_{v \in V} E(v)$ .

8. Set

$$g(\epsilon) := \int_a^b f(x, u(x) + \epsilon\phi(x), u'(x) + \epsilon\phi'(x)) dx,$$

where  $\epsilon$ ,  $|\epsilon| < \epsilon_0$ , is a real parameter,  $f(x, z, p)$  in  $C^2$  in his arguments and  $u, \phi \in C^1[a, b]$ . Calculate  $g'(0)$  and  $g''(0)$ .

9. Find all  $C^2$ -solutions  $u = u(x)$  of

$$\frac{d}{dx} f_{u'} = f_u,$$

if  $f = \sqrt{1 + (u')^2}$ .

10. Set

$$E(v) = \int_0^1 (v^2(x) + xv'(x)) dx$$

and

$$V = \{v \in C^1[0, 1] : v(0) = 0, v(1) = 1\}.$$

Show that  $\min_{v \in V} E(v)$  has no solution.

11. Is there a solution of  $\min_{v \in V} E(v)$ , where  $V = C[0, 1]$  and

$$E(v) = \int_0^1 \left( \int_0^{v(x)} (1 + \zeta^2) d\zeta \right) dx ?$$

12. Let  $u \in C^2(a, b)$  be a solution of Euler's differential equation. Show that  $u' f_{u'} - f \equiv \text{const.}$ , provided that  $f = f(u, u')$ , i. e.,  $f$  depends not explicitly on  $x$ .

13. Consider the problem of rotationally symmetric surfaces  $\min_{v \in V} |\mathcal{S}(v)|$ , where

$$|\mathcal{S}(v)| = 2\pi \int_0^l v(x) \sqrt{1 + (v'(x))^2} dx$$

and

$$V = \{v \in C^1[0, l] : v(0) = a, v(l) = b, v(x) > 0 \text{ on } (a, b)\}.$$

Find  $C^2(0, l)$ -solutions of the associated Euler equation.

*Hint:* Solutions are catenoids (chain curves, in German: Kettenlinien).

14. Find solutions of Euler's differential equation to the Brachistochrone problem  $\min_{v \in V} E(v)$ , where

$$V = \{v \in C[0, a] \cap C^2(0, a) : v(0) = 0, v(a) = A, v(x) > 0 \text{ if } x \in (0, a)\},$$

that is, we consider here as comparison functions graphs over the  $x$ -axis, and

$$E(v) = \int_0^a \frac{\sqrt{1 + v'^2}}{\sqrt{v}} dx .$$

*Hint:* (i) Euler's equation implies that

$$y(1 + y'^2) = \alpha^2, \quad y = y(x),$$

with a constant  $\alpha$ .

(ii) Substitution

$$y = \frac{c}{2}(1 - \cos u), \quad u = u(x),$$

implies that  $x = x(u)$ ,  $y = y(u)$  define cycloids (in German: Rollkurven).

15. Prove the basic lemma in the calculus of variations: Let  $\Omega \subset \mathbb{R}^n$  be a domain and  $f \in C(\Omega)$  such that

$$\int_{\Omega} f(x)h(x) dx = 0$$

for all  $h \in C_0^1(\Omega)$ . Then  $f \equiv 0$  in  $\Omega$ .

16. Write the minimal surface equation as a quasilinear equation of second order.

17. Prove that a minimizer in  $C^1(\overline{\Omega})$  of

$$E(v) = \int_{\Omega} F(x, v, \nabla v) \, dx - \int_{\partial\Omega} g(v, v) \, ds,$$

is a solution of the boundary value problem, provided that additionally  $u \in C^2(\overline{\Omega})$ ,

$$\begin{aligned} \sum_{i=1}^n \frac{\partial}{\partial x_i} F_{u_{x_i}} &= F_u \quad \text{in } \Omega \\ \sum_{i=1}^n F_{u_{x_i}} \nu_i &= g_u \quad \text{on } \partial\Omega, \end{aligned}$$

where  $\nu = (\nu_1, \dots, \nu_n)$  is the exterior unit normal at the boundary  $\partial\Omega$ .



## Chapter 2

# Functions of n variables

In this chapter, with only few exceptions, the normed space will be the  $n$ -dimensional Euclidean space  $\mathbb{R}^n$ . Let  $f$  be a real function defined on a nonempty subset  $X \subseteq \mathbb{R}^n$ . In the conditions below where derivatives occur, we assume that  $f \in C^1$  or  $f \in C^2$  on an *open* set  $X \subseteq \mathbb{R}^n$ .

### 2.1 Optima, tangent cones

Let  $f$  be a real-valued functional defined on a nonempty subset  $V \subseteq X$ .

**Definition.** We say that an element  $x \in V$  defines a *global minimum* of  $f$  in  $V$ , if

$$f(x) \leq f(y) \quad \text{for all } y \in V,$$

and we say that  $x \in V$  defines a *strict global minimum*, if the strict inequality holds for all  $y \in V$ ,  $y \neq x$ .

For a  $\rho > 0$  we define a ball  $B_\rho(x)$  with radius  $\rho$  and center  $x$ :

$$B_\rho(x) = \{y \in \mathbb{R}^n; \|y - x\| < \rho\},$$

where  $\|y - x\|$  denotes the Euclidean norm of the vector  $x - y$ . We always assume that  $x \in V$  is *not isolated* i. e., we assume that  $V \cap B_\rho(x) \neq \{x\}$  for all  $\rho > 0$ .

**Definition.** We say that an element  $x \in V$  defines a *local minimum* of  $f$  in  $V$  if there exists a  $\rho > 0$  such that

$$f(x) \leq f(y) \quad \text{for all } y \in V \cap B_\rho(x),$$

and we say that  $x \in V$  defines a *strict* local minimum if the strict inequality holds for all  $y \in V \cap B_\rho(x)$ ,  $y \neq x$ .

That is, a global minimum is a local minimum. By reversing the directions of the inequality signs in the above definitions, we obtain definitions of *global maximum*, *strict global maximum*, *local maximum* and *strict local maximum*. An *optimum* is a minimum or a maximum and a *local optimum* is a local minimum or a local maximum. If  $x$  defines a local maximum etc. of  $f$ , then  $x$  defines a local minimum etc. of  $-f$ , i. e., we can restrict ourselves to the consideration of minima.

In the important case that  $V$  and  $f$  are convex, then each local minimum defines also a global minimum. These assumptions are satisfied in many applications to problems in microeconomy.

**Definition.** A subset  $V \subseteq X$  is said to be *convex* if for any two vectors  $x, y \in V$  the inclusion  $\lambda x + (1 - \lambda)y \in V$  holds for all  $0 \leq \lambda \leq 1$ .

**Definition.** We say that a functional  $f$  defined on a convex subset  $V \subseteq X$  is *convex* if

$$f(\lambda x + (1 - \lambda)y) \leq \lambda f(x) + (1 - \lambda)f(y)$$

for all  $x, y \in V$  and for all  $0 \leq \lambda \leq 1$ , and  $f$  is *strictly* convex if the strict inequality holds for all  $x, y \in V$ ,  $x \neq y$ , and for all  $\lambda$ ,  $0 < \lambda < 1$ .

**Theorem 2.1.1.** *If  $f$  is a convex functional on a convex set  $V \subseteq X$ , then any local minimum of  $f$  in  $V$  is a global minimum of  $f$  in  $V$ .*

*Proof.* Suppose that  $x$  is no global minimum, then there exists an  $x^1 \in V$  such that  $f(x^1) < f(x)$ . Set  $y(\lambda) = \lambda x^1 + (1 - \lambda)x$ ,  $0 < \lambda < 1$ , then

$$f(y(\lambda)) \leq \lambda f(x^1) + (1 - \lambda)f(x) < \lambda f(x) + (1 - \lambda)f(x) = f(x).$$

For each given  $\rho > 0$  there exists a  $\lambda = \lambda(\rho)$  such that  $y(\lambda) \in B_\rho(x)$  and  $f(y(\lambda)) < f(x)$ . This is a contradiction to the assumption.  $\square$

Concerning the uniqueness of minimizers one has the following result.

**Theorem 2.1.2.** *If  $f$  is a strictly convex functional on a convex set  $V \subseteq X$ , then a minimum (local or global) is unique.*

*Proof.* Suppose that  $x^1, x^2 \in V$  define minima of  $f$ , then  $f(x^1) = f(x^2)$ ,



see Theorem 2.1.1. Assume  $x^1 \neq x^2$ , then for  $0 < \lambda < 1$

$$f(\lambda x^1 + (1 - \lambda)x^2) < \lambda f(x^1) + (1 - \lambda)f(x^2) = f(x_1) = f(x_2).$$

This is a contradiction to the assumption that  $x^1, x^2$  define global minima.  
□

**Theorem 2.1.3.** a) If  $f$  is a convex function and  $V \subset X$  a convex set, then the set of minimizers is convex.

b) If  $f$  is concave,  $V \subset X$  convex, then the set of maximizers is convex.

*Proof.* Exercise.

In the following we use for  $(f_{x_1}(x), \dots, f_{x_n}(x))$  the abbreviations  $f'(x)$ ,  $\nabla f(x)$  or  $Df(x)$ .

**Theorem 2.1.4.** Suppose that  $V \subset X$  is convex. Then  $f$  is convex on  $V$  if and only if

$$f(y) - f(x) \geq \langle f'(x), y - x \rangle \quad \text{for all } x, y \in V.$$

*Proof.* (i) Assume  $f$  is convex. Then for  $0 \leq \lambda \leq 1$  we have

$$\begin{aligned} f(\lambda y + (1 - \lambda)x) &\leq \lambda f(y) + (1 - \lambda)f(x) \\ f(x + \lambda(y - x)) &\leq f(x) + \lambda(f(y) - f(x)) \\ f(x) + \lambda \langle f'(x), y - x \rangle + o(\lambda) &\leq f(x) + \lambda(f(y) - f(x)), \end{aligned}$$

which implies that

$$\langle f'(x), y - x \rangle \leq f(y) - f(x).$$

(ii) Set for  $x, y \in V$  and  $0 < \lambda < 1$

$$x^1 := (1 - \lambda)y + \lambda x \quad \text{and} \quad h := y - x^1.$$

Then

$$x = x^1 - \frac{1 - \lambda}{\lambda} h.$$

Since we suppose that the inequality of the theorem holds, we have

$$\begin{aligned} f(y) - f(x^1) &\geq \langle f'(x^1), y - x^1 \rangle = \langle f'(x^1), h \rangle \\ f(x) - f(x^1) &\geq \langle f'(x^1), x - x^1 \rangle = -\frac{1 - \lambda}{\lambda} \langle f'(x^1), h \rangle. \end{aligned}$$

After multiplying the first inequality with  $(1-\lambda)/\lambda$  we add both inequalities and get

$$\begin{aligned} \frac{1-\lambda}{\lambda}f(y) - \frac{1-\lambda}{\lambda}f(x^1) + f(x) - f(x^1) &\geq 0 \\ (1-\lambda)f(y) + \lambda f(x) - (1-\lambda)f(x^1) - \lambda f(x^1) &\geq 0. \end{aligned}$$

Thus

$$(1-\lambda)f(y) + \lambda f(x) \geq f(x^1) \equiv f((1-\lambda)y - \lambda x)$$

for all  $0 < \lambda < 1$ . □

**Remark.** The inequality of the theorem says that the surface  $\mathcal{S}$  defined by  $z = f(y)$  is above of the tangent plane  $T_x$  defined by  $z = \langle f'(x), y-x \rangle + f(x)$ , see Figure 2.1 for the case  $n = 1$ .

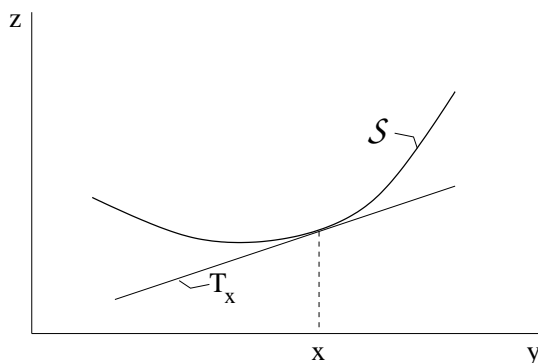

Figure 2.1: Figure to Theorem 2.1.4

The following definition of a local tangent cone is fundamental for our considerations, particularly for the study of necessary conditions in constrained optimization. The tangent cone plays the role of the tangent plane in unconstrained optimization.

**Definition.** A nonempty subset  $C \subseteq \mathbb{R}^n$  is said to be a *cone* with vertex at  $z \in \mathbb{R}^n$ , if  $y \in C$  implies that  $z + t(y - z) \in C$  for each  $t > 0$ .

Let  $V$  be a nonempty subset of  $X$ .

**Definition.** For given  $x \in V$  we define the *local tangent cone* of  $V$  at  $x$  by

$$T(V, x) = \{w \in \mathbb{R}^n : \text{there exist sequences } x^k \in V, t_k \in \mathbb{R}, t_k > 0, \\ \text{such that } x^k \rightarrow x \text{ and } t_k(x^k - x) \rightarrow w \text{ as } k \rightarrow \infty\}.$$

This definition implies immediately

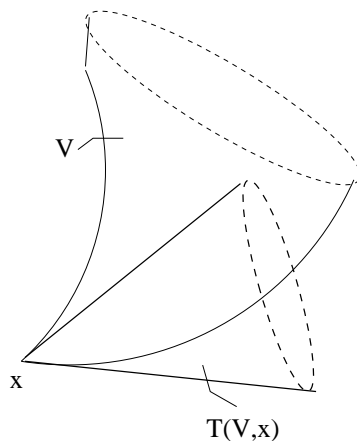

Figure 2.2: Tangent cone

**Corollaries.** (i) *The set  $T(V, x)$  is a cone with vertex at zero.*

(ii) *A vector  $x \in V$  is not isolated if and only if  $T(V, x) \neq \{0\}$ .*

(iii) *Suppose that  $w \neq 0$ , then  $t_k \rightarrow \infty$ .*

(iv)  *$T(V, x)$  is closed.*

(v)  *$T(V, x)$  is convex if  $V$  is convex.*

In the following the Hesse matrix  $(f_{x_i x_j})_{i,j=1}^n$  is also denoted by  $f''(x)$ ,  $f_{xx}(x)$  or  $D^2 f(x)$ .

**Theorem 2.1.5.** *Suppose that  $V \subset \mathbb{R}^n$  is nonempty and convex. Then*

(i) *If  $f$  is convex on  $V$ , then the Hesse matrix  $f''(x)$ ,  $x \in V$ , is positive semidefinite on  $T(V, x)$ . That is,*

$$\langle f''(x)w, w \rangle \geq 0$$

for all  $x \in V$  and for all  $w \in T(V, x)$ .

(ii) Assume the Hesse matrix  $f''(x)$ ,  $x \in V$ , is positive semidefinite on  $Y = V - V$ , the set of all  $x - y$  where  $x, y \in V$ . Then  $f$  is convex on  $V$ .

*Proof.* (i) Assume  $f$  is convex on  $V$ . Then for all  $x, y \in V$ , see Theorem 2.1.4,

$$f(y) - f(x) \geq \langle f'(x), y - x \rangle.$$

Thus

$$\begin{aligned} \langle f'(x), y - x \rangle + \frac{1}{2} \langle f''(x)(y - x), y - x \rangle + o(\|y - x\|^2) &\geq \langle f'(x), y - x \rangle \\ \langle f''(x)(y - x), y - x \rangle + \|y - x\|^2 \eta(\|y - x\|) &\geq 0, \end{aligned}$$

where  $\lim_{t \rightarrow 0} \eta(t) = 0$ . Suppose that  $w \in T(V, x)$  and that  $t_k, x^k \rightarrow x$  are associated sequences, i. e.,  $x^k \in V$ ,  $t_k > 0$  and

$$w^k := t_k(x^k - x) \rightarrow w.$$

Then

$$\langle f''(x)w^k, w^k \rangle + \|w^k\|^2 \eta(\|x^k - x\|) \geq 0,$$

which implies that

$$\langle f''(x)w, w \rangle \geq 0.$$

(ii) Since

$$f(y) - f(x) - \langle f'(x), y - x \rangle = \frac{1}{2} \langle f''(x + \delta(y - x))(y - x), y - x \rangle,$$

where  $0 < \delta < 1$ , and the right hand side is nonnegative, it follows from Theorem 2.1.4 that  $f$  is convex on  $V$ .  $\square$

## 2.1.1 Exercises

1. Assume  $V \subset \mathbb{R}^n$  is a convex set. Show that  $Y = V - V := \{x - y : x, y \in V\}$  is a convex set in  $\mathbb{R}^n$ ,  $0 \in Y$  and if  $y \in Y$  then  $-y \in Y$ .
2. Prove Theorem 2.1.3.
3. Show that  $T(V, x)$  is a cone with vertex at zero.
4. Assume  $V \subseteq \mathbb{R}^n$ . Show that  $T(V, x) \neq \{0\}$  if and only if  $x \in V$  is not isolated.
5. Show that  $T(V, x)$  is closed.
6. Show that  $T(V, x)$  is convex if  $V$  is a convex set.
7. Suppose that  $V$  is convex. Show that

$$T(V, x) = \{w \in \mathbb{R}^n; \text{there exist sequences } x^k \in V, t_k \in \mathbb{R}, t_k > 0, \\ \text{such that } t_k(x^k - x) \rightarrow w \text{ as } k \rightarrow \infty\}.$$

8. Assume if  $w \in T(V, x)$ ,  $w \neq 0$ . Then  $t_k \rightarrow \infty$ , where  $t_k$  are the reals from the definition of the local tangent cone.
9. Let  $p \in V \subset \mathbb{R}^n$  and  $|p|^2 = p_1^2 + \dots + p_n^2$ . Prove that

$$f(p) = \sqrt{1 + |p|^2}$$

is convex on convex sets  $V$ .

*Hint:* Show that the Hesse matrix  $f''(p)$  is nonnegative by calculating  $\langle f''(p)\zeta, \zeta \rangle$ , where  $\zeta \in \mathbb{R}^n$ .

10. Suppose that  $f''(x)$ ,  $x \in V$ , is positive on  $(V - V) \setminus \{0\}$ . Show that  $f(x)$  is strictly convex on  $V$ .

*Hint:* (i) Show that  $f(y) - f(x) > \langle f'(x), y - x \rangle$  for all  $x, y \in V$ ,  $x \neq y$ .  
(ii) Then show that  $f$  is strictly convex by adapting part (ii) of the proof of Theorem 2.1.4.

11. Let  $V \subset X$  be a nonempty convex subset of a linear space  $X$  and  $f : V \mapsto \mathbb{R}$ . Show that  $f$  is convex on  $V$  if and only if  $\Phi(t) := f(x + t(y - x))$  is convex on  $t \in [0, 1]$  for all (fixed)  $x, y \in V$ .

*Hint:* To see that  $\Phi$  is convex if  $f$  is convex we have to show

$$\Phi(\lambda s_1 + (1 - \lambda)s_2) \leq \lambda\Phi(s_1) + (1 - \lambda)\Phi(s_2),$$

$0 \leq \lambda \leq 1$ ,  $s_i \in [0, 1]$ . Set  $\tau = \lambda s_1 + (1 - \lambda)s_2$ , then

$$\Phi(\tau) = f(x + \tau(y - x))$$

and

$$\begin{aligned} x + \tau(y - x) &= x + (\lambda s_1 + (1 - \lambda)s_2)(y - x) \\ &= \lambda(x + s_1(y - x)) + (1 - \lambda)(x + s_2(y - x)). \end{aligned}$$

## 2.2 Necessary conditions

The proof of the following necessary condition follows from assumption  $f \in C^1(X)$  and the definition of the tangent cone.

We recall that  $f$  is said to be differentiable at  $x \in X \subset \mathbb{R}^n$ ,  $X$  open, if all partial derivatives exist at  $x$ . In contrast to the case  $n = 1$  it does not follow that  $f$  is continuous at  $x$  if  $f$  is differentiable at that point.

**Definition.**  $f$  is called *totally differentiable* at  $x$  if there exists an  $a \in \mathbb{R}^n$  such that

$$f(y) = f(x) + \langle a, y - x \rangle + o(\|x - y\|)$$

as  $y \rightarrow x$ .

We recall that

(1) If  $f$  is totally differentiable at  $x$ , then  $f$  is differentiable at  $x$  and  $a = f'(x)$ .

(2) If  $f \in C^1(B_\rho)$ , then  $f$  is totally differentiable at every  $x \in B_\rho$ .

(3) Rademacher's Theorem. *If  $f$  is locally Lipschitz continuous in  $B_\rho$ , then  $f$  is totally differentiable almost everywhere in  $B_\rho$ , i. e., up to a set of Lebesgue measure zero.*

For a proof of Rademacher's Theorem see [15], pp. 81, for example.

**Theorem 2.2.1** (Necessary condition of first order). *Suppose that  $f \in C^1(X)$  and that  $x$  defines a local minimum of  $f$  in  $V$ . Then*

$$\langle f'(x), w \rangle \geq 0 \quad \text{for all } w \in T(V, x).$$

*Proof.* Let  $t_k, x^k$  be associated sequences to  $w \in T(V, x)$ . Then, since  $x$  defines a local minimum, it follows

$$0 \leq f(x^k) - f(x) = \langle f'(x), x^k - x \rangle + o(\|x^k - x\|),$$

which implies that

$$0 \leq \langle f'(x), t_k(x^k - x) \rangle + \|t_k(x^k - x)\| \eta(\|x^k - x\|),$$

where  $\lim_{t \rightarrow 0} \eta(t) = 0$ . Letting  $n \rightarrow \infty$  we obtain the necessary condition.  $\square$

**Corollary.** *Suppose that  $V$  is convex, then the necessary condition of Theorem 1.1.1 is equivalent to*

$$\langle f'(x), y - x \rangle \geq 0 \quad \text{for all } y \in V.$$

*Proof.* From the definition of the tangent cone it follows that the corollary implies Theorem 2.2.1. On the other hand, fix  $y \in V$  and define  $x^k := (1 - \lambda_k)y + \lambda_k x$ ,  $\lambda_k \in (0, 1)$ ,  $\lambda_k \rightarrow 1$ . Then  $x^k \in V$ ,  $(1 - \lambda_k)^{-1}(x^k - x) = y - x$ . That is,  $y - x \in T(V, x)$ .  $\square$

The variational inequality above is equivalent to a fixed point equation, see Theorem 2.2.2 below.

Let  $p_V(z)$  be the projection of  $z \in H$ , where  $H$  is a real Hilbert space, onto a nonempty closed convex subset  $V \subseteq H$ , see Section 2.6.3 of the appendix.

We have  $w = p_V(z)$  if and only if

$$\langle p_V(z) - z, y - p_V(z) \rangle \geq 0 \quad \text{for all } y \in V. \quad (2.1)$$

**Theorem 2.2.2** (Equivalence of a variational inequality to an equation). *Suppose that  $V$  is a closed convex and nonempty subset of a real Hilbert space  $H$  and  $F$  a mapping from  $V$  into  $H$ . Then the variational inequality*

$$x \in V : \langle F(x), y - x \rangle \geq 0 \quad \text{for all } y \in V.$$

*is equivalent to the fixed point equation*

$$x = p_V(x - qF(x)) ,$$

*where  $0 < q < \infty$  is an arbitrary fixed constant.*

*Proof.* Set  $z = x - qF(x)$  in (2.1). If  $x = p_V(x - qF(x))$  then the variational inequality follows. On the other hand, the variational inequality

$$x \in V : \langle x - (x - qF(x)), y - x \rangle \geq 0 \quad \text{for all } y \in V$$

implies that the fixed point equation holds and the above theorem is shown.  $\square$



**Remark.** This equivalence of a variational inequality with a fixed point equation suggests a simple numerical procedure to calculate solutions of variational inequalities:  $x^{k+1} := p_V(x^k - qF(x^k))$ . Then the hope is that the sequence  $x^k$  converges if  $0 < q < 1$  is chosen appropriately. In these notes we do not consider the problem of convergence of this or of related numerical procedures. This projection-iteration method runs quite well in some examples, see [51], and exercises in Section 2.5.

In generalization to the necessary condition of second order in the unconstrained case,  $\langle f''(x)h, h \rangle \geq 0$  for all  $h \in \mathbb{R}^n$ , we have a corresponding result in the constrained case.

**Theorem 2.2.3** (Necessary condition of second order). *Suppose that  $f \in C^2(X)$  and that  $x$  defines a local minimum of  $f$  in  $V$ . Then for each  $w \in T(V, x)$  and every associated sequences  $t_k$ ,  $x^k$  the inequality*

$$0 \leq \liminf_{k \rightarrow \infty} t_k \langle f'(x), w^k \rangle + \frac{1}{2} \langle f''(x)w, w \rangle$$

holds, where  $w^k := t_k(x^k - x)$ .

*Proof.* From

$$\begin{aligned} f(x) &\leq f(x_k) \\ &= f(x) + \langle f'(x), x^k - x \rangle + \frac{1}{2} \langle f''(x)(x^k - x), x^k - x \rangle \\ &\quad + \|x^k - x\|^2 \eta(\|x^k - x\|), \end{aligned}$$

where  $\lim_{t \rightarrow 0} \eta(t) = 0$ , we obtain

$$0 \leq t_k \langle f'(x), w^k \rangle + \frac{1}{2} \langle f''(x)w^k, w^k \rangle + \|w^k\|^2 \eta(\|x^k - x\|).$$

By taking  $\liminf$  the assertion follows.  $\square$

In the next sections we will exploit the explicit nature of the subset  $V$ . When the side conditions which define  $V$  are equations, then we obtain under an additional assumption from the necessary condition of first order the classical Lagrange multiplier rule.

### 2.2.1 Equality constraints

Here we suppose that the subset  $V$  is defined by

$$V = \{y \in \mathbb{R}^n; g_j(y) = 0, j = 1, \dots, m\}.$$

Let  $g_j \in C^1(\mathbb{R}^n)$ ,  $w \in T(V, x)$  and  $t_k, x^k$  associated sequences to  $w$ . Then

$$0 = g_j(x^k) - g_j(x) = \langle g'_j(x), x^k - x \rangle + o(\|x^k - x\|),$$

and from the definition of the local tangent cone it follows for each  $j$  that

$$\langle g'_j(x), w \rangle = 0 \quad \text{for all } w \in T(V, x). \quad (2.2)$$

Set  $Y = \text{span} \{g'_1(x), \dots, g'_m(x)\}$  and let  $\mathbb{R}^n = Y \oplus Y^\perp$  be the orthogonal decomposition with respect to the standard Euclidean scalar product  $\langle a, b \rangle$ . We recall that  $\dim Y^\perp = n - k$  if  $\dim Y = k$ .

Equations (2.2) imply immediately that  $T(V, x) \subseteq Y^\perp$ . Under an additional assumption we have equality.

**Lemma 2.2.1.** *Suppose that  $\dim Y = m$  (maximal rank condition), then  $T(V, x) = Y^\perp$ .*

*Proof.* It remains to show that  $Y^\perp \subseteq T(V, x)$ . Suppose that  $z \in Y^\perp$ ,  $0 < \epsilon \leq \epsilon_0$ ,  $\epsilon_0$  sufficiently small. Then we look for solutions  $y = o(\epsilon)$ , depending on the fixed  $z$ , of the system  $g_j(x + \epsilon z + y) = 0$ ,  $j = 1, \dots, m$ . Since  $z \in Y^\perp$  and the maximal rank condition is satisfied, we obtain the existence of a  $y = o(\epsilon)$  as  $\epsilon \rightarrow 0$  from the implicit function theorem. That is, we have  $x(\epsilon) := x + \epsilon z + y \in V$ , where  $y = o(\epsilon)$ . This implies that  $z \in T(V, x)$  since  $x(\epsilon) \rightarrow x$ ,  $x(\epsilon) \in V$  and  $\epsilon^{-1}(x(\epsilon) - x) \rightarrow z$  as  $\epsilon \rightarrow 0$ .  $\square$

From this lemma follows the simplest version of the Lagrange multiplier rule as a necessary condition of first order.

**Theorem 2.2.4** (Lagrange multiplier rule, equality constraints). *Suppose that  $x$  defines a local minimum of  $f$  in  $V$  and that the maximal rank condition of Lemma 2.1.1 is satisfied. Then there exists uniquely determined  $\lambda_j \in \mathbb{R}$ , such that*

$$f'(x) + \sum_{j=1}^m \lambda_j g'_j(x) = 0.$$

*Proof.* From the necessary condition  $\langle f'(x), w \rangle \geq 0$  for all  $w \in T(V, x)$  and from Lemma 2.2.1 it follows that  $\langle f'(x), w \rangle = 0$  for all  $w \in Y^\perp$  since  $Y^\perp$  is a linear space. This equation implies that

$$f'(x) \in Y \equiv \text{span} \{g'_1(x), \dots, g'_m(x)\}.$$

Uniqueness of the multipliers follow from the maximal rank condition.  $\square$

There is a necessary condition of second order linked with a Lagrange function  $L(x, \lambda)$  defined by

$$L(x, \lambda) = f(x) + \sum_{j=1}^m \lambda_j g_j(x).$$

Moreover, under an additional assumption the sequence  $t_k \langle f'(x), w^k \rangle$ , where  $w^k := t_k(x^k - x)$ , is convergent, and the limit is independent of the sequences  $x^k$ ,  $t_k$  associated to a given  $w \in T(V, x)$ .

We will use the following abbreviations:

$$L'(x, \lambda) := f'(x) + \sum_{j=1}^m \lambda_j g_j'(x) \quad \text{and} \quad L''(x, \lambda) := f''(x) + \sum_{j=1}^m \lambda_j g_j''(x).$$

**Theorem 2.2.5** (Necessary condition of second order, equality constraints).

Suppose that  $f, g_j \in C^2(\mathbb{R}^n)$  and that the maximal rank condition of Lemma 2.2.1 is satisfied. Let  $x$  be a local minimizer of  $f$  in  $V$  and let  $\lambda = (\lambda_1, \dots, \lambda_m)$  be the (uniquely determined) Lagrange multipliers of Theorem 2.2.4. Then

- (i)  $\langle L''(x, \lambda)z, z \rangle \geq 0$  for all  $z \in Y^\perp$  ( $\equiv T(V, x)$ ),
- (ii)  $\lim_{k \rightarrow \infty} t_k \langle f'(x), w^k \rangle = \frac{1}{2} \sum_{j=1}^m \lambda_j \langle g_j''(x)w, w \rangle$ ,  $w_k := t_k(x^k - x)$ ,  
for all  $w \in T(V, x)$  and for all associated sequences  $x^k$ ,  $t_k$   
to  $w \in T(V, x)$  ( $\equiv Y^\perp$ ).

*Proof.* (i) For given  $z \in Y^\perp$ ,  $\|z\| = 1$ , and  $0 < \epsilon \leq \epsilon_0$ ,  $\epsilon_0 > 0$  sufficiently small, there is a  $y = o(\epsilon)$  such that  $g_j(x + \epsilon z + y) = 0$ ,  $j = 1, \dots, m$ , which follows from the maximal rank condition and the implicit function theorem. Then

$$\begin{aligned} f(x + \epsilon z + y) &= L(x + \epsilon z + y, \lambda) \\ &= L(x, \lambda) + \langle L'(x, \lambda), \epsilon z + y \rangle \\ &\quad + \frac{1}{2} \langle L''(x, \lambda)(\epsilon z + y), \epsilon z + y \rangle + o(\epsilon^2) \\ &= f(x) + \frac{1}{2} \langle L''(x, \lambda)(\epsilon z + y), \epsilon z + y \rangle + o(\epsilon^2), \end{aligned}$$

since  $L'(x, \lambda) = 0$  and  $x$  satisfies the side conditions. Hence, since  $f(x) \leq f(x + \epsilon z + y)$ , it follows that  $\langle L''(x, \lambda)z, z \rangle \geq 0$ .

(ii) Suppose that  $x^k \in V$ ,  $t_k > 0$ , such that  $w^k := t_k(x^k - x) \rightarrow w$ . Then

$$\begin{aligned} L(x^k, \lambda) &\equiv f(x^k) + \sum_{j=1}^m \lambda_j g_j(x^k) \\ &= L(x, \lambda) + \frac{1}{2} \langle L''(x, \lambda)(x^k - x), x^k - x \rangle + o(\|x^k - x\|^2). \end{aligned}$$

That is,

$$f(x^k) - f(x) = \frac{1}{2} \langle L''(x, \lambda)(x^k - x), x^k - x \rangle + o(\|x^k - x\|^2).$$

On the other hand,

$$f(x^k) - f(x) = \langle f'(x), x^k - x \rangle + \frac{1}{2} \langle f''(x)(x^k - x), x^k - x \rangle + o(\|x^k - x\|^2).$$

Consequently

$$\langle f'(x), x^k - x \rangle = \frac{1}{2} \sum_{j=1}^m \lambda_j \langle g_j''(x)(x^k - x), x^k - x \rangle + o(\|x^k - x\|^2),$$

which implies (ii) of the theorem.  $\square$

### 2.2.2 Inequality constraints

We define two index sets by  $I = \{1, \dots, m\}$  and  $E = \{m+1, \dots, m+p\}$  for integers  $m \geq 1$  and  $p \geq 0$ . If  $p = 0$  then we set  $E = \emptyset$ , the empty set. In this section we assume that the subset  $V$  is given by

$$V = \{y \in \mathbb{R}^n; g_j(y) \leq 0 \text{ for each } j \in I \text{ and } g_j(y) = 0 \text{ for each } j \in E\}$$

and that  $g_j \in C^1(\mathbb{R}^n)$  for each  $j \in I \cup E$ . Let  $x \in V$  be a local minimizer of  $f$  in  $V$  and let  $I_0 \subseteq I$  be the subset of  $I$  where the inequality constraints are active, that is,  $I_0 = \{j \in I; g_j(x) = 0\}$ . Let  $w \in T(V, x)$  and  $x^k$ ,  $t_k$  are associated sequences to  $w$ , then for  $k \geq k_0$ ,  $k_0$  sufficiently large, we have for each  $j \in I_0$

$$0 \geq g_j(x^k) - g_j(x) = \langle g_j'(x), x^k - x \rangle + o(\|x^k - x\|).$$

It follows that for each  $j \in I_0$

$$\langle g'_j(x), w \rangle \leq 0 \quad \text{for all } w \in T(V, x).$$

If  $j \in E$ , we obtain from

$$0 = g_j(x^k) - g_j(x) = \langle g'_j(x), x^k - x \rangle + o(\|x^k - x\|)$$

and if  $j \in E$ , then

$$\langle g'_j(x), w \rangle = 0 \quad \text{for all } w \in T(V, x).$$

That is, the tangent cone  $T(V, x)$  is a subset of the cone

$$K = \{z \in \mathbb{R}^n : \langle g'_j(x), z \rangle = 0, j \in E, \text{ and } \langle g'_j(x), z \rangle \leq 0, j \in I_0\}.$$

Under a maximal rank condition we have equality. By  $|M|$  we denote the number of elements of a finite set  $M$ , we set  $|M| = 0$  if  $M = \emptyset$ .

**Definition.** A vector  $x \in V$  is said to be a *regular point* if

$$\dim(\text{span } \{g'_j(x)\}_{j \in E \cup I_0}) = |E| + |I_0|.$$

It means that in a regular point the gradients of functions which define the active constraints (equality constraints are included) are linearly independent.

**Lemma 2.2.2.** *Suppose that  $x \in V$  is a regular point, then  $T(V, x) = K$ .*

*Proof.* It remains to show that  $K \subseteq T(V, x)$ . Suppose that  $z \in K$ ,  $0 < \epsilon \leq \epsilon_0$ ,  $\epsilon_0$  sufficiently small. Then we look for solutions  $y \in \mathbb{R}^n$  of the system  $g_j(x + \epsilon z + y) = 0$ ,  $j \in E$  and  $g_j(x + \epsilon z + y) \leq 0$ ,  $j \in I_0$ . Once one has established such a  $y = o(\epsilon)$ , depending on the fixed  $z \in K$ , then it follows that  $z \in T(V, x)$  since  $x(\epsilon) := x + \epsilon z + y \in V$ ,  $x(\epsilon) \rightarrow x$ ,  $x(\epsilon) \in V$  and  $\epsilon^{-1}(x(\epsilon) - x) \rightarrow z$  as  $\epsilon \rightarrow 0$ .

Consider the subset  $I'_0 \subseteq I_0$  defined by  $I'_0 = \{j \in I_0; \langle g'_j(x), z \rangle = 0\}$ . Then, the existence of a solution  $y = o(\epsilon)$  of the system  $g_j(x + \epsilon z + y) = 0$ ,  $j \in E$  and  $g_j(x + \epsilon z + y) = 0$ ,  $j \in I'_0$  follows from the implicit function theorem since

$$\dim(\text{span } \{g'_j(x)\}_{j \in E \cup I'_0}) = |E| + |I'_0|$$

holds. The remaining inequalities  $g_j(x + \epsilon z + y) \leq 0$ ,  $j \in I_0 \setminus I'_0$ , are satisfied for sufficiently small  $\epsilon > 0$  since  $\langle g_j(x), z \rangle < 0$  if  $j \in I_0 \setminus I'_0$ , the proof is completed.  $\square$

Thus the necessary condition of first order of Theorem 2.1.1 is here

$$\langle f'(x), w \rangle \geq 0 \quad \text{for all } w \in K (\equiv T(V, x)), \quad (2.3)$$

if the maximal rank condition of Lemma 2.2.2 is satisfied, that is, if  $x \in V$  is a regular point.

In generalization of the case of equality constraints the variational inequality (2.3) implies the following Lagrange multiplier rule.

**Theorem 2.2.6** (Lagrange multiplier rule, inequality constraints). *Suppose that  $x$  is a local minimizer of  $f$  in  $V$  and that  $x$  is a regular point. Then there exists  $\lambda_j \in \mathbb{R}$ ,  $\lambda_j \geq 0$  if  $j \in I_0$ , such that*

$$f'(x) + \sum_{j \in E \cup I_0} \lambda_j g'_j(x) = 0.$$

*Proof.* Since the variational inequality (2.3) with

$$K = \{z \in \mathbb{R}^n : \langle g'_j(x), z \rangle \geq 0 \text{ and } \langle -g'_j(x), z \rangle \geq 0 \text{ for each } j \in E, \\ \text{and } \langle -g'_j(x), z \rangle \geq 0 \text{ for each } j \in I_0\}$$

is satisfied, there exists nonnegative real numbers  $\mu_j$  if  $j \in I_0$ ,  $\mu_j^{(1)}$  if  $j \in E$  and  $\mu_j^{(2)}$  if  $j \in E$  such that

$$\begin{aligned} f'(x) &= \sum_{j \in I_0} \mu_j (-g'_j(x)) + \sum_{j \in E} \mu_j^{(1)} g'_j(x) + \sum_{j \in E} \mu_j^{(2)} (-g'_j(x)) \\ &= - \sum_{j \in I_0} \mu_j g'_j(x) + \sum_{j \in E} (\mu_j^{(1)} - \mu_j^{(2)}) g'_j(x). \end{aligned}$$

This follows from the Minkowski–Farkas Lemma, see Section 2.6: let  $A$  be a real matrix with  $m$  rows and  $n$  columns and let  $b \in \mathbb{R}^n$ , then  $\langle b, y \rangle \geq 0 \forall y \in \mathbb{R}^n$  with  $Ay \geq 0$  if and only if there exists an  $x \in \mathbb{R}^m$ , such that  $x \geq 0$  and  $A^T x = b$ .  $\square$

The following corollary says that we can avoid the consideration whether the inequality constraints are active or not.

**Kuhn–Tucker conditions.** *Let  $x$  be a local minimizer of  $f$  in  $V$  and suppose that  $x$  is a regular point. Then there exists  $\lambda_j \in \mathbb{R}$ ,  $\lambda_j \geq 0$  if  $j \in I$ , such that*

$$\begin{aligned} f'(x) + \sum_{j \in E \cup I} \lambda_j g'_j(x) &= 0, \\ \sum_{j \in I} \lambda_j g_j(x) &= 0. \end{aligned}$$

As in the case of equality constraints there is a necessary condition of second order linked with a Lagrange function.

**Theorem 2.2.7** (Necessary condition of second order, inequality constraints). *Suppose that  $f, g_j \in C^2(\mathbb{R}^n)$ . Let  $x$  be a local minimizer of  $f$  in  $V$  which is regular and  $\lambda_j$  denote Lagrange multipliers such that*

$$f'(x) + \sum_{j \in E \cup I_0} \lambda_j g'_j(x) = 0,$$

where  $\lambda_j \geq 0$  if  $j \in I_0$ . Let  $I_0^+ = \{j \in I_0; \lambda_j > 0\}$ ,  $V_0 = \{y \in V; g_j(y) = 0 \text{ for each } j \in I_0^+\}$ ,  $Z = \{y \in \mathbb{R}^n : \langle g'_j(x), y \rangle = 0 \text{ for each } j \in E \cup I_0^+\}$  and  $L(y, \lambda) \equiv f(y) + \sum_{j \in E \cup I_0} \lambda_j g_j(y)$ . Then

- (i)  $T(V_0, x) = Z$ ,
- (ii)  $\langle L''(x, \lambda)z, z \rangle \geq 0$  for all  $z \in T(V_0, x)$  ( $\equiv Z$ ),
- (iii)  $\lim_{k \rightarrow \infty} t_k \langle f'(x), w_k \rangle = \frac{1}{2} \sum_{j \in E \cup I_0} \lambda_j \langle g''_j(x)w, w \rangle$ ,  $w^k := t_k(x^k - x)$ ,

for all  $w \in T(V_0, x)$  and for all associated sequences  $x^k$ ,  $t_k$  to  $w \in T(V_0, x)$  ( $\equiv Z$ ).

*Proof.* Assertion (i) follows from the maximal rank condition and the implicit function theorem. Since  $f(y) = L(y, \lambda)$  for all  $y \in V_0$ , we obtain

$$\begin{aligned} f(y) - f(x) &= \langle L'(x, \lambda), y - x \rangle + \frac{1}{2} \langle L''(x, \lambda)(y - x), y - x \rangle + o(\|x - y\|^2) \\ &= \frac{1}{2} \langle L''(x, \lambda)(y - x), y - x \rangle + o(\|x - y\|^2). \end{aligned}$$

On the other hand

$$f(y) - f(x) = \langle f'(x), y - x \rangle + \frac{1}{2} \langle f''(x)(y - x), y - x \rangle + o(\|y - x\|^2).$$

Since  $f(y) \geq f(x)$  if  $y$  is close enough to  $x$ , we obtain (ii) and (iii) by the same reasoning as in the proof of Theorem 2.2.5.  $\square$

### 2.2.3 Supplement

In the above considerations we have focused our attention on the necessary condition that  $x \in V$  is a local minimizer:  $\langle f'(x), w \rangle \geq 0$  for all  $w \in C(V, x)$ . Then we asked what follows from this inequality when  $V$  is defined by equations or inequalities. Under an additional assumption (maximal rank condition) we derived Lagrange multiplier rules.

In the case that  $V$  is defined by equations or inequalities there is a more general Lagrange multiplier rule where no maximal rank condition is assumed. Let

$$V = \{y \in \mathbb{R}^n : g_j(y) \leq 0 \text{ for each } j \in I \text{ and } g_j(y) = 0 \text{ for each } j \in E\}.$$

The case where the side conditions are only equations is included, here  $I$  is empty.

**Theorem 2.2.8** (General Lagrange multiplier rule). *Suppose that  $x$  defines a local minimum or a local maximum of  $f$  in  $V$  and that  $|E| + |I_0| < n$ . Then there exists  $\lambda_j \in \mathbb{R}$ , not all are zero, such that*

$$\lambda_0 f'(x) + \sum_{j \in E \cup I_0} \lambda_j g'_j(x) = 0.$$

*Proof.* We will show by contradiction that the vectors  $f'(x)$ ,  $g'_j(x)$ ,  $j \in E \cup I_0$ , must be linearly dependent if  $x$  defines a local minimum.

By assumption we have  $g_j(x) = 0$  if  $j \in E \cup I_0$  and  $g_j(x) < 0$  if  $j \in I \setminus I_0$ . Assume that the vectors  $f'(x)$ ,  $g'_1(x), \dots, g'_m(x), g'_{m+l_1}(x), \dots, g'_{m+l_k}(x)$  are linearly independent, where  $I_0 = \{m + l_1, \dots, m + l_k\}$ . Then there exists a regular quadratic submatrix of  $N = 1 + m + k$  rows (and columns) of the associated matrix to the above (column) vectors. One can assume, after renaming of the variables, that this matrix is

$$\begin{pmatrix} f_{x_1}(x) & g_{1,x_1}(x) & \cdots & g_{N-1,x_1}(x) \\ f_{x_2}(x) & g_{1,x_2}(x) & \cdots & g_{N-1,x_2}(x) \\ \dots & \dots & \dots & \dots \\ f_{x_N}(x) & g_{1,x_N}(x) & \cdots & g_{N-1,x_N}(x) \end{pmatrix}.$$



Here  $g_{i,x_j}$  denote the partial derivative of  $g_i$  with respect to  $x_j$ . Set  $h = f(x)$ , then we consider the following system of equations:

$$\begin{aligned} f(y_1, \dots, y_N, x_{N+1}, \dots, x_n) &= h + u \\ g_j(y_1, \dots, y_N, x_{N+1}, \dots, x_n) &= 0, \quad j \in E \cup I_0, \end{aligned}$$

where  $y_1, \dots, y_N$  are unknowns. The real number  $u$  is a given parameter in a neighbourhood of zero, say  $|u| < u_0$  for a sufficiently small  $u_0$ . From the implicit function theorem it follows that there exists a solution  $y_i = \phi_i(u)$ ,  $i = 1, \dots, N$ , where  $\phi_i(0) = x_i$ . Set  $x^* = (\phi_1(u), \dots, \phi_N(u), x_{N+1}, \dots, x_n)$ . Then  $f(x^*) > f(x)$  if  $u > 0$  and  $f(x^*) < f(x)$  if  $u < 0$ , i. e.,  $x$  defines no local optimum.  $\square$

From this multiplier rule it follows immediately:

1. If  $x$  is a regular point, then  $\lambda_0 \neq 0$ . After dividing by  $\lambda_0$  the new coefficients  $\lambda'_j = \lambda_j/\lambda_0$ ,  $j \in E \cup I_0$ , coincide with the Lagrange multipliers of Theorem 2.7.
2. If  $\lambda_0 = 0$ , then  $x$  is no regular point.

## 2.2.4 Exercises

1. Suppose that  $f \in C^1(B_\rho)$ . Show that

$$f(y) = f(x) + \langle f'(x), y - x \rangle + o(\|y - x\|)$$

for every  $x \in B_\rho$ , that is,  $f$  is totally differentiable in  $B_\rho$ .

2. Assume  $g$  maps a ball  $B_\rho(x) \subset \mathbb{R}^n$  in  $\mathbb{R}^m$  and let  $g \in C^1(B_\rho)$ . Suppose that  $g(x) = 0$  and  $\dim Y = m$  (maximal rank condition), where  $Y = \text{span}\{g'_1(x), \dots, g'_m(x)\}$ . Prove that for fixed  $z \in Y^\perp$  there exists  $y(\epsilon)$  which maps  $(-\epsilon_0, \epsilon_0)$ ,  $\epsilon_0 > 0$  sufficiently small, into  $\mathbb{R}^m$ ,  $y \in C^1(-\epsilon_0, \epsilon_0)$  and  $y(\epsilon) = o(\epsilon)$  such that  $g(x + \epsilon z + y(\epsilon)) \equiv 0$  in  $(-\epsilon_0, \epsilon_0)$ .

*Hint:* After renaming the variables we can assume that the matrix  $g_{i,x_j}$ ,  $i, j = 1, \dots, m$  is regular. Set  $y := (y_1, \dots, y_m, 0, \dots, 0)$  and  $f(\epsilon, y) := (g_1(x + \epsilon z + y), \dots, g_m(x + \epsilon z + y))$ . From the implicit function theorem it follows that there exists a  $C^1$  function  $y = y(\epsilon)$ ,  $|\epsilon| < \epsilon_1$ ,  $\epsilon_1 > 0$  sufficiently small, such that  $f(\epsilon, y(\epsilon)) \equiv 0$  in  $|\epsilon| < \epsilon_1$ . Since  $g_j(x + \epsilon z + y(\epsilon)) = 0$ ,  $j = 1, \dots, m$  and  $y(\epsilon) = \epsilon a + o(\epsilon)$ , where  $a = (a_1, \dots, a_m, 0, \dots, 0)$  it follows that  $a = 0$  holds.

3. Find the smallest eigenvalue of the variational inequality

$$x \in C : \quad \langle Ax, y - x \rangle \geq \lambda \langle x, y - x \rangle \quad \text{for all } y \in C ,$$

where  $C = \{x \in \mathbb{R}^3; x_1 \geq 0 \text{ and } x_3 \leq 0\}$  and  $A$  is the matrix

$$A = \begin{pmatrix} 2 & -1 & 0 \\ -1 & 2 & -1 \\ 0 & -1 & 2 \end{pmatrix} .$$

## 2.3 Sufficient conditions

As in the unconstrained case we will see that sufficient conditions are close to necessary conditions of second order. Let  $x$  be a local minimizer of  $f \in C^2$  in the unconstrained case  $V \equiv \mathbb{R}^n$ , then  $f'(x) = 0$  and  $\langle f''(x)z, z \rangle \geq 0$  for all  $z \in \mathbb{R}^n$ . That means, the first eigenvalue  $\lambda_1$  of the Hessian matrix  $f''(x)$  is nonnegative. If  $\lambda_1 > 0$ , then from expansion (1.2) follows that  $x$  defines a strict local minimum of  $f$  in  $V$ .

Let  $V \subseteq \mathbb{R}^n$  be a nonempty subset and suppose that  $x \in V$  satisfies the necessary condition of first order, see Theorem 2.2.1:

$$(\star) \quad \langle f'(x), w \rangle \geq 0 \quad \text{for all } w \in T(V, x).$$

We are interested in additional assumptions under which  $x$  then defines a local minimum of  $f$  in  $V$ . For the following reasoning we will need an assumption which is stronger than the necessary condition  $(\star)$ .

**Assumption A.** Let  $w \in T(V, x)$  and  $x^k$  and  $t_k$  associated sequences. Then there exists an  $M > -\infty$  such that

$$\liminf_{k \rightarrow \infty} t_k^2 \langle f'(x), x^k - x \rangle \geq M .$$

**Remarks.** (i) Assumption A implies that the necessary condition  $(\star)$  of first order holds.

(ii) Assume the necessary condition  $(\star)$  is satisfied and  $V$  is convex, then assumption A holds with  $M = 0$ .

The following subcone of  $T(V, x)$  plays an important role in the study of sufficient conditions, see also Chapter 3, where the infinitely dimensional case is considered.

**Definition.** Let  $T_{f'}(V, x)$  be the set of all  $w \in T(V, x)$  such that, if  $x^k$  and  $t_k = \|x^k - x\|^{-1}$  are associated sequences to  $w$ , then  $\limsup_{k \rightarrow \infty} t_k^2 \langle f'(u), x^k - x \rangle < \infty$ .

Set

$$f'(x)^\perp = \{y \in \mathbb{R}^n; \langle f'(x), y \rangle = 0\} .$$

**Corollary.** Suppose that assumption A is satisfied (this is the case if  $V$  is

convex), then

$$T_{f'}(V, x) \subseteq T(V, x) \cap f'(x)^\perp .$$

*Proof.* Assume that  $w \in T_{f'}(V, x)$  and let  $t_k$  and  $x^k$  be associated sequences. If  $w \neq 0$ , then  $t_k \rightarrow \infty$  and assumption A implies that  $\langle f'(x), w \rangle \geq 0$ , see Remark 2.2. On the other hand, the inequality  $\liminf_{k \rightarrow \infty} t_k^2 \langle f'(x), x^k - x \rangle < \infty$  yields  $\langle f'(x), w \rangle \leq 0$ .  $\square$

From an indirect argument follows a sufficient criterion.

**Theorem 2.3.1.** *Suppose that  $f \in C^2(\mathbb{R}^n)$ . Then a nonisolated  $x \in V$  defines a strict local minimum of  $f$  in  $V$  if  $T_{f'}(V, x) = \{0\}$  or if assumption A is satisfied for each  $w \in T_{f'}(V, x)$  with an  $M \geq 0$  and  $\langle f''(x)w, w \rangle > 0$  holds for all  $w \in T_{f'}(V, x) \setminus \{0\}$ .*

*Proof.* If  $x$  does not define a strict local minimum, then there exists a sequence  $x^k \in V$ ,  $x^k \rightarrow x$ ,  $x^k \neq x$ , such that

$$\begin{aligned} 0 &\geq f(x^k) - f(x) \\ &= \langle f'(x), x^k - x \rangle + \frac{1}{2} \langle f''(x)(x^k - x), x^k - x \rangle + o(\|x^k - x\|^2) . \end{aligned}$$

Set  $t_k = \|x^k - x\|^{-1}$ , then

$$\begin{aligned} 0 &\geq t_k^2 \langle f'(x), x^k - x \rangle + \frac{1}{2} \langle f''(x)(t_k(x^k - x)), t_k(x^k - x) \rangle \\ &\quad + t_k^2 \|x^k - x\|^2 \frac{o(\|x^k - x\|^2)}{\|x^k - x\|^2} . \end{aligned}$$

For a subsequence we have  $t_k(x^k - x) \rightarrow w$ ,  $\|w\| = 1$ . The above inequality implies that  $w \in T_{f'}(V, x)$ . Since assumption (A) is satisfied with  $M \geq 0$  it follows that  $0 \geq \langle f''(x)w, w \rangle$ , a contradiction to the assumption of the theorem. Since  $w \in T_{f'}(V, x) \neq \{0\}$  if  $x$  is no strict local minimizer, it follows that  $x$  defines a strict local minimum if  $T_{f'}(V, x) = \{0\}$ .  $\square$

The following example shows that  $T_{f'}(V, x)$  can be a proper subset of  $C(V, x) \cap f'(x)^\perp$ .

*Example.* Let  $f(x) = x_2 - c(x_1^2 + x_2^2)$ ,  $c > 0$ , and  $V = \{x \in \mathbb{R}^2 : 0 \leq x_1 < \infty \text{ and } x_1^\alpha \leq x_2 < \infty\}$ , where  $1 < \alpha < \infty$ . Since  $f'(0) = (0, 1)$ , the vector

$x = (0, 0)$  satisfies the necessary condition  $\langle f'(0), y - 0 \rangle \geq 0$  for all  $y \in V$ . We ask whether  $x = (0, 0)$  defines a local minimum of  $f$  in  $V$ . A corollary from above implies that  $T_{f'}(V, x) = \{0\}$  or that  $T_{f'}(V, x) = \{y \in \mathbb{R}^2; y_2 = 0 \text{ and } y_1 \geq 0\}$ . If  $1 < \alpha < 2$ , then  $T_{f'}(V, x) = \{0\}$ , see an exercise. In this case  $(0, 0)$  defines a strict local minimum of  $f$  in  $V$ , see Theorem 2.3.1. In the case  $2 \leq \alpha < \infty$  we find that the vector  $(1, 0)$  is in  $T_{f'}(V, x)$ . Thus the assumption of Theorem 2.3.1 is not satisfied since

$$f''(0) = -2c \begin{pmatrix} 1 & 0 \\ 0 & 1 \end{pmatrix}.$$

By taking a sequence  $y = (x_1, x_1^\alpha)$ ,  $x_1 \rightarrow 0$ , it follows that  $(0, 0)$  defines no local minimum if  $2 < \alpha < \infty$ . In the borderline case  $\alpha = 2$  it depends on  $c$  whether or not  $(0, 0)$  defines a local minimum.

### 2.3.1 Equality constraints

We assume here that the subset  $V$  is given by

$$V = \{y \in \mathbb{R}^n : g_j(y) = 0, j = 1, \dots, m\},$$

where  $f$  and  $g_j$  are  $C^2$  functions. Set

$$L(y, \lambda) = f(y) + \sum_{j=1}^m \lambda_j g_j(y),$$

where  $\lambda = (\lambda_1, \dots, \lambda_m)$ ,  $\lambda_j \in \mathbb{R}$ .

**Theorem 2.3.2** (Sufficient condition, equality constraints). *Assume a nonisolated  $x \in V$  satisfies  $L'(x, \lambda) = 0$  and  $\langle L''(x, \lambda)z, z \rangle > 0$  for all  $z \in T(V, x) \setminus \{0\}$ . Then  $x$  defines a strict local minimum of  $f$  in  $V$ .*

*Proof.* Since  $f(y) = L(y, \lambda)$  for all  $y \in V$  we obtain for  $x, x^k \in V$

$$\begin{aligned} f(x^k) - f(x) &= \langle L'(x, \lambda), x^k - x \rangle + \frac{1}{2} \langle L''(x, \lambda)(x^k - x), x^k - x \rangle \\ &\quad + o(\|x^k - x\|^2) \\ &= \frac{1}{2} \langle L''(x, \lambda)(x^k - x), x^k - x \rangle + o(\|x^k - x\|^2). \end{aligned}$$

If  $x$  is no strict local minimizer, then there exists a sequence  $x^k \in V$ ,  $x^k \rightarrow x$  and  $x^k \neq x$  such that

$$0 \geq \frac{1}{2} \langle L''(x, \lambda)(x^k - x), x^k - x \rangle + o(\|x^k - x\|^2)$$

holds, which implies that

$$0 \geq \frac{1}{2} \langle L''(x, \lambda) t_k(x^k - x), t_k(x^k - x) \rangle + \frac{o(\|x^k - x\|^2)}{\|x^k - x\|^2},$$

where  $t_k := \|x^k - x\|^{-1}$ . For a subsequence we have  $t_k(x^k - x) \rightarrow w$ ,  $\|w\| = 1$  and  $w \in T(V, x)$ , which is a contradiction to the assumption of the theorem.  $\square$

We recall (see Lemma 2.2.2) that the tangent cone  $T(V, x)$  is a hyperplane given by  $\{y \in \mathbb{R}^n; \langle g'_j(x), y \rangle = 0, \text{ for every } j\}$  if the maximal rank condition of Lemma 2.2.2 is satisfied.

### 2.3.2 Inequality constraints

Here we use the notations of previous sections (inequality constraints, necessary conditions).

**Theorem 2.3.3** (Sufficient condition, inequality constraints). *Suppose that  $x \in V$  is nonisolated and that there exists multipliers  $\lambda_j$  such that  $L'(x, \lambda) = 0$ , where*

$$L(y, \lambda) = f(y) + \sum_{j \in E \cup I_0} \lambda_j g_j(y),$$

$\lambda_j \geq 0$  if  $j \in I_0$ . Let  $I_0^+$  be the subset of  $I_0$  defined by  $I_0^+ = \{j \in I_0; \lambda_j > 0\}$ . Set  $T_0 \equiv \{z \in T(V, x) : \langle g'_j(x), z \rangle = 0 \text{ for each } j \in I_0^+\}$ . Then  $x$  is strict local minimizer of  $f$  in  $V$  if  $T_0 = \{0\}$  or if  $\langle L''(x, \lambda)z, z \rangle > 0$  for all  $z \in T_0 \setminus \{0\}$ .

*Proof.* Set

$$G(y, \lambda) := - \sum_{j \in I_0^+} \lambda_j g_j(y),$$

then  $G(x, \lambda) = 0$ ,  $G(y, \lambda) \geq 0$  for all  $y \in V$  and  $f(y) \equiv L(y, \lambda) + G(y, \lambda)$ . If  $x$  is no strict local minimizer, then there exists a sequence  $x^k \in V$ ,  $x^k \rightarrow$

$x$ ,  $x^k \neq x$ , such that

$$\begin{aligned}
0 &\geq f(x^k) - f(x) \\
&= L(x^k, \lambda) - L(x, \lambda) + G(x^k, \lambda) - G(x, \lambda) \\
&= \langle L'(x, \lambda), x^k - x \rangle + \frac{1}{2} \langle L''(x, \lambda)(x^k - x), x^k - x \rangle + G(x^k, \lambda) \\
&\quad + o(\|x^k - x\|^2) \\
&= \frac{1}{2} \langle L''(x, \lambda)(x^k - x), x^k - x \rangle + G(x^k, \lambda) + o(\|x^k - x\|^2),
\end{aligned}$$

Set  $t_k = \|x^k - x\|^{-1}$ , then

$$0 \geq \frac{1}{2} \langle L''(x, \lambda)(t_k(x^k - x)), t_k(x^k - x) \rangle + t_k^2 G(x^k, \lambda) + \frac{o(\|x^k - x\|^2)}{\|x^k - x\|^2}. \quad (2.4)$$

This inequality implies that  $t_k^2 G(x^k, \lambda)$  is bounded from above. Since  $G(y, \lambda) \geq 0$  for all  $y \in V$ , it follows that  $t_k G(x^k, \lambda) \rightarrow 0$ . On the other hand

$$t_k G(x^k, \lambda) = \langle G'(x, \lambda), t_k(x^k - x) \rangle + \frac{o(\|x^k - x\|)}{\|x^k - x\|},$$

which follows since  $G(x^k, \lambda) - G(x, \lambda) = G(x^k, \lambda)$  holds. Thus we find that  $\langle G'(x, \lambda), w \rangle = 0$ , where  $w$  is the limit of a subsequence of  $t_k(x^k - x)$ ,  $t_k \equiv \|x^k - x\|^{-1}$ . Since  $w \in C(V, x)$  we have  $\langle g'_j(x), w \rangle \leq 0$  if  $j \in I_0^+$ . Hence, since per definition  $\lambda_j > 0$  if  $j \in I_0^+$ , we obtain from the definition of  $G(y, \lambda)$  that

$$\langle g'_j(x), w \rangle = 0 \quad \text{for each } j \in I_0^+ \quad (2.5)$$

From  $G(x^k, \lambda) \geq 0$  it follows from inequality (2.4) that  $\langle L''(x, \lambda)w, w \rangle \leq 0$ . This inequality and equations (2.5) contradict the assumption of the theorem. Since the proof shows that  $T_0 \neq \{0\}$  if  $x$  is no strict local minimizer, it follows that  $x$  defines a strict local minimum if  $T_0 = \{0\}$ .  $\square$

**Remark.** The above proof is mainly based on the observation that the sequence  $t_k^2 G(x^k, \lambda)$  remains bounded from above. In the general case of a set  $V$  which defines the side condition we have that the sequence  $t_k^2 \langle f'(x), x^k - x \rangle$  remains bounded from above. In the infinitely dimensional case we must exploit this fact much more than in the above finitely dimensional case where it was enough to use the conclusion that  $\langle f'(x), w \rangle = 0$ .

**2.3.3 Exercises**

1. Show that assumption A implies that the necessary condition of first order  $\langle f'(x), w \rangle \geq 0$  holds for all  $w \in T(V, x)$ .
2. Show that  $T_{f'}(V, x) = \{0\}$  in the above example if  $1 < \alpha < 2$  holds.
3. Assume  $f \in C^1(\mathbb{R}^n)$  and that  $V$  is given by  $V = \{y \in \mathbb{R}^n : a_i \leq y_i \leq b_i\}$ . Show that the variational inequality  $x \in V : \langle f'(x), y - x \rangle \geq 0$  for all  $y \in V$  is equivalent to the corresponding Lagrange multiplier equation  $f'(x) = -\sum_{j \in I_0} \lambda_j e^j$ , where  $\lambda_j \geq 0$  if  $x_j = b_j$  and  $\lambda_j \leq 0$  if  $x_j = a_j$ . The index set  $I_0$  denotes the set of active indices.



## 2.4 Kuhn-Tucker theory

Here we consider again the problem of maximizing a real function under side conditions given by inequalities. Set

$$V = \{y \in X : g^j(y) \geq 0, j = 1, \dots, m\},$$

where  $X \subset \mathbb{R}^n$  is a given nonempty convex set, and consider the maximum problem

$$(P) \quad \max_{y \in V} f(y).$$

In contrast to the previous considerations, we do not assume that  $f$  or  $g_j$  are differentiable. But the most theorems in this section require that  $f$  and  $g^j$  are concave functions. Define, as in the previous section, the Lagrange function

$$L(x, \lambda) = f(x) + \sum_{j=1}^m \lambda_j g^j(x).$$

**Definition.** A couple  $(x^0, \lambda^0)$ , where  $x^0 \in X$  and  $\lambda^0 \geq 0$  is called *saddle point* of  $L(x, \lambda)$  if

$$L(x, \lambda^0) \leq L(x^0, \lambda^0) \leq L(x^0, \lambda)$$

for all  $x \in X$  and for all  $\lambda \geq 0$ , see Figure 2.3 for an illustration of a saddle point. The relationship between saddle points and the problem (P) is the

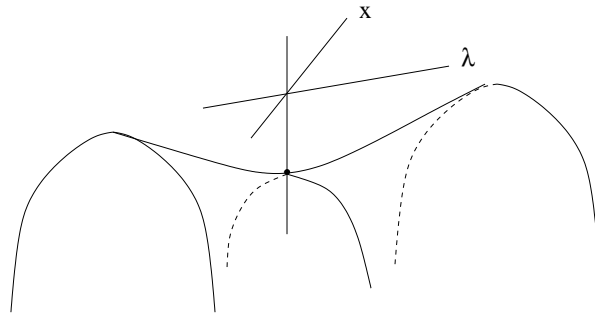

Figure 2.3: Saddle point

content of the Kuhn-Tucker theory.

**Theorem 2.4.1.** *Suppose that  $(x^0, \lambda^0)$  is a saddle point. Then*

$$\begin{aligned} g^j(x^0) &\geq 0, \quad j = 1, \dots, m, \\ \sum_{j=1}^m \lambda_j^0 g^j(x^0) &= 0. \end{aligned}$$

*Proof.* The assumption says that

$$f(x) + \sum_{j=1}^m \lambda_j^0 g^j(x) \leq f(x^0) + \sum_{j=1}^m \lambda_j^0 g^j(x^0) \leq f(x^0) + \sum_{j=1}^m \lambda_j g^j(x^0)$$

for all  $x \in X$  and for all  $\lambda \geq 0$ . Set  $\lambda_j = 0$  if  $j \neq l$ , divide by  $\lambda_l > 0$  and letting  $\lambda_l \rightarrow \infty$ , we get  $g^l(x^0) \geq 0$  for every  $l$ . Set  $\lambda = 0$ . Then  $\sum_{j=1}^m \lambda_j^0 g^j(x^0) \leq 0$ . Since  $\lambda_j^0 \geq 0$  and  $g^j(x^0) \geq 0$ , the equation of the theorem follows.  $\square$

**Theorem 2.4.2.** *Suppose that  $(x^0, \lambda^0)$  is a saddle point. Then  $x^0$  is a global maximizer of  $f$  in  $V$ .*

*Proof.* Since

$$f(x) + \sum_{j=1}^m \lambda_j^0 g^j(x) \leq f(x^0)$$

it follows that  $f(x) \leq f(x^0)$  for all  $x \in X$  satisfying  $g^j(x) \geq 0$ .  $\square$

The following is a basic result on inequalities in convex optimization. We write  $w > 0$  or sometimes  $w \gg 0$ , if all coordinates of the vector  $w$  are positive.

**Theorem 2.4.3.** *Suppose that  $X \subset \mathbb{R}^n$  is nonempty and convex and  $g^j : X \rightarrow \mathbb{R}$ ,  $j = 1, \dots, k$ , are concave. Assume there is no solution  $x \in X$  of the system of inequalities  $g^j(x) > 0$ ,  $j = 1, \dots, k$ . Then there are  $\lambda_j \geq 0$ , not all of them are zero, such that*

$$\sum_{j=1}^k \lambda_j g^j(x) \leq 0$$

for all  $x \in X$ .

*Proof.* Set  $g(x) = (g^1(x), \dots, g^k(x))$  and define

$$Z_x = \{z \in \mathbb{R}^k : z < g(x)\}$$

and  $Z = \cup_{x \in X} Z_x$ . We have  $0_k \notin Z$ , otherwise  $0 < g^j(x)$  for an  $x \in X$  and for all  $j$ , a contradiction to the above assumption. Since  $Z$  is convex, see an exercise, it follows from a separation theorem for convex sets, see Section 2.6, that there is a  $p^0 \neq 0$  such that

$$\langle p^0, z \rangle \geq \langle p^0, 0 \rangle$$

for all  $z \in Z$ . We have  $p^0 \leq 0$  since with  $z = (z_1, \dots, z_l, \dots, z_k) \in Z$  also  $z' = (z_1, \dots, t, \dots, z_k) \in Z$  for all  $t \leq z_l$ . Dividing by negative  $t$  and let  $t \rightarrow -\infty$  we find that every coordinate of  $p^0$  must be nonpositive. Set  $p = -p^0$ , then  $\langle p, z \rangle \leq 0$  for all  $z \in Z$ . Another representation of  $Z$  is

$$Z = \{g(x) - \epsilon : x \in X, \epsilon > 0\}.$$

Thus,

$$\langle p, g(x) - \epsilon \rangle \leq 0$$

for all  $x \in X$  and for all  $\epsilon > 0$ . Consequently  $\langle p, g(x) \rangle \leq 0$  for all  $x \in X$ .  $\square$

Replacing  $g$  by  $-g$ , we get

**Corollary.** Suppose  $X \subset \mathbb{R}^n$  is convex and all  $g^j : X \mapsto \mathbb{R}$  are convex. Then either the system  $g^j(x) < 0$ ,  $j = 1, \dots, k$  has a solution  $x \in X$  or there is a  $p \geq 0$ , not all coordinates zero, such that  $\langle p, g(x) \rangle \geq 0$  for all  $x \in X$ .

The main theorem of the Kuhn-Tucker theory, is

**Theorem 2.4.4** (Kuhn and Tucker [31]). *Suppose that  $X \subset \mathbb{R}^n$  is nonempty and convex, and let  $f, g^j : X \mapsto \mathbb{R}$  are concave. If  $x^0$  is a solution of problem (P), then there exists nonnegative constants  $p_0, p_1, \dots, p_m$ , not all of them are zero, such that*

$$p_0 f(x) + \sum_{j=1}^m p_j g^j(x) \leq p_0 f(x^0) \text{ for all } x \in X \text{ and}$$

$$\sum_{j=1}^m p_j g^j(x^0) = 0.$$

*Proof.* By assumption there is no solution  $x \in X$  of the system  $g(x) \geq 0$  and  $f(x) - f(x^0) > 0$ . Then there is no solution of  $g(x) > 0$  and  $f(x) - f(x^0) > 0$  too. Then there are nonnegative constants  $p_0, p_1, \dots, p_m$ , not all of them are zero, such that

$$p_0(f(x) - f(x^0)) + \sum_{j=1}^m p_j g^j(x) \leq 0$$

for all  $x \in X$ , see Theorem 2.4.3. Set  $x = x^0$ , then it follows that

$$\sum_{j=1}^m p_j g^j(x^0) \leq 0.$$

In fact, we have equality since  $p_j \geq 0$  and  $g^j(x^0) \geq 0$ . □

Under an additional assumption (Slater condition) we have  $p_0 > 0$ .

**Definition.** We say that the system of inequalities  $g(x) \geq 0$  satisfies the *Slater condition* if there exists an  $x^1 \in X$  such that  $g(x^1) > 0$ .

**Theorem 2.4.5.** *Suppose that the assumptions of the previous theorem are fulfilled and additionally that the Slater condition holds. Then there are nonnegative constants  $\lambda_j^0$ ,  $j = 1, \dots, m$  such that  $(x^0, \lambda^0)$ ,  $\lambda^0 = (\lambda_1^0, \dots, \lambda_m^0)$ , is a saddle point of the Lagrange function  $L(x, \lambda) = f(x) + \sum_{j=1}^m \lambda_j g^j(x)$ .*

*Proof.* If  $p_0 = 0$ , then  $\sum_{j=1}^m p_j g^j(x) \leq 0$  for all  $x \in X$ , and, in particular,  $\sum_{j=1}^m p_j g^j(x^1) \leq 0$  which is a contradiction to the Slater condition. Set  $\lambda_j^0 = p_j/p_0$ ,  $j = 1, \dots, m$ , then

$$f(x) + \langle \lambda^0, g(x) \rangle \leq f(x^0).$$

Since  $\langle \lambda^0, g(x^0) \rangle = 0$ , we obtain that  $L(x, \lambda^0) \leq L(x^0, \lambda^0)$ , and  $L(x^0, \lambda^0) \leq L(x^0, \lambda)$  follows since  $\lambda \geq 0$  and  $g(x^0) \geq 0$ . □

**Lemma.** *Suppose that  $(x^0, \lambda^0)$  is a saddle point of  $L(x, \lambda)$ ,  $X$  is convex and  $f, g \in C^1$ . Then*

$$\langle L'(x^0, \lambda^0), x - x^0 \rangle \leq 0$$

for all  $x \in X$ .

*Proof.* The lemma is a consequence of  $L(x^0, \lambda^0) \geq L(x, \lambda^0)$  for all  $x \in X$ .

**Definition** The following equations and inequalities are called *Kuhn-Tucker conditions* for  $(x^0, \lambda^0)$ :

- (i)  $\langle L'(x^0, \lambda^0), x - x^0 \rangle \leq 0$  for all  $x \in X$ ,
- (ii)  $g(x^0) \geq 0$ ,
- (iii)  $\langle \lambda^0, g(x) \rangle = 0$ ,
- (iv)  $\lambda^0 \geq 0$ .

From the above Theorem 2.4.4, Theorem 2.4.5 and the previous lemma it follows

**Theorem 2.4.6** (A necessary condition). *Assume  $X \subset \mathbb{R}^n$  is convex,  $f, g^j$  are in  $C^1$  and concave on  $X$  and that the Slater condition holds. If  $x^0$  is a solution of the maximum problem (P), then there exists a vector  $\lambda^0$  such that the Kuhn-Tucker conditions are satisfied.*

**Theorem 2.4.7** (A sufficient condition). *Suppose that  $X$  is convex,  $f, g^j$  are concave and in  $C^1$ . If  $(x^0, \lambda^0)$  satisfies the Kuhn-Tucker conditions then  $x^0$  is a global maximizer in  $X$  of  $f$  under the side conditions  $g(x) \geq 0$ , that is of the problem (P).*

*Proof.* The function

$$L(x, \lambda^0) = f(x) + \langle \lambda^0, g(x) \rangle$$

is concave in  $x$  since  $\lambda^0 \geq 0$ . It follows that

$$\begin{aligned} L(x, \lambda^0) - L(x^0, \lambda^0) &\leq \langle L'(x^0, \lambda^0), x - x^0 \rangle \\ &\leq 0 \end{aligned}$$

for all  $x \in X$ . The second inequality is the first of the Kuhn-Tucker conditions. On the other hand we have

$$\begin{aligned} L(x^0, \lambda) - L(x^0, \lambda^0) &= \langle L_\lambda(x^0, \lambda^0), \lambda - \lambda^0 \rangle \\ &= \langle g(x^0), \lambda - \lambda^0 \rangle \\ &= \langle g(x^0), \lambda \rangle \\ &\geq 0. \end{aligned}$$

Thus we have shown that  $(x^0, \lambda^0)$  is a saddle point. Then the assertion of the theorem follows from Theorem 2.4.2.  $\square$

**Example: Profit maximizing**

This example was taken from [3], p. 65. Suppose that a firm produces a good and let  $q$  be the real number of the produced goods (output). Assume there are  $n$  different goods which the production needs (input) and let  $x_j$  the real number of the good  $j$  which are used. Set  $x = (x_1, \dots, x_n)$  and let  $r = (r_1, \dots, r_n)$  be the associated given price vector. We make the assumption  $q \leq f(x)$ , where  $f$  denotes the given production function. Then the problem of profit maximizing is

$$\max(pq - \langle r, x \rangle)$$

under the side conditions  $q \leq f(x)$ ,  $x \geq 0$  and  $q \geq 0$ .

Define the convex set

$$X = \{(q, x) \in \mathbb{R}^{n+1} : q \geq 0, x \geq 0\}$$

and let

$$L(x, \lambda) = pq - \langle r, x \rangle + \lambda(f(x) - q)$$

be the associated Lagrange function. We suppose that  $f$  is concave in  $x \geq 0$ ,  $f(0) = 0$ ,  $f(x) > 0$  if  $x \geq 0$  and not  $x = 0$ , and  $f_{x_j}(0) > 0$  for at least one  $j$ , which implies that the Slater condition is satisfied. From above we have that the Kuhn-Tucker conditions are necessary and sufficient that  $(q^0, x^0) \in X$  is a global maximizer of the profit  $pq - \langle r, x \rangle$  under the side conditions. That is, we have to consider the following inequalities and one equation for  $q^0 \geq 0$  and  $x \geq 0$ :

- (i)  $(p - \lambda^0)(q - q^0) + \sum_{j=1}^n (-r_j + \lambda^0 f_{x_j}(x^0))(x_j - x_j^0) \leq 0$  for all  $(q, x) \in X$ ,
- (ii)  $f(x^0) - q^0 \geq 0$ ,
- (iii)  $\lambda^0(f(x^0) - q^0) = 0$ ,
- (iv)  $\lambda^0 \geq 0$ .

**Corollaries.** (a)  $q^0 = 0$  implies that  $x^0 = 0$ .

(b) If  $q^0 > 0$ , then  $\lambda^0 = p$ ,  $f(x^0) = q^0$  and  $r_j = pf_{x_j}(x^0)$  if  $x_j > 0$ .

**Remark.** If  $q^0 > 0$  and  $x^0 > 0$ , then  $x^0$  is a solution of the nonlinear system  $pf'(x) = r$ . If the Hesse matrix  $f''(x)$  is negative or positive definite on  $x > 0$ , which implies that  $f$  is strictly concave, then solutions are uniquely determined, see an exercise.

**2.4.1 Exercises**

1. Set  $Z_x = \{z \in \mathbb{R}^k : z < f(x)\}$  and  $Z = \cup_{x \in X} Z_x$ , see the proof of Theorem 2.4.3. Show that  $Z$  is convex if  $X$  is convex and  $f$  is concave on  $X$ .
2. Prove that solutions  $x \in \mathbb{R}^n$ ,  $x > 0$ , of  $f'(x) = b$ , where  $b \in \mathbb{R}^n$ , are uniquely determined if the Hesse matrix  $f''(x)$  is negative or positive definite for all  $x > 0$ .

## 2.5 Examples

### 2.5.1 Maximizing of utility

This example was taken from [3], p. 44. Set  $X := \{x \in \mathbb{R}^n : x_i > 0, i, \dots, n\}$ , which is called the consumption set. By writing  $x \gg 0$  we mean that  $x_i > 0$  for each  $i$ . Let  $p \in \mathbb{R}^n$ ,  $p \gg 0$ , the vector of prices for the  $n$  commodities  $x_i$  and  $m$  denotes the available income of the consumer. Concerning the utility function  $U(x)$  we assume that  $U \in C^2(X)$  is strictly concave and  $U' \gg 0 \forall x \in X$ . The assumption  $U' \gg 0$  reflects the microeconomic principle “more is better”. Set  $V = \{x \in X : \langle p, x \rangle \leq m\}$  and consider the problem of maximizing of the utility, that is,  $\max_{x \in V} U(x)$  under the budget restriction  $\langle p, x \rangle \leq m$ . Assume  $x^0 \in V$  is a solution, then  $\langle p, x^0 \rangle = m$ , which follows from the assumption  $U_{x_i} >$  for each  $i$ . Thus, one can replace the above problem by  $\max_{x \in V'} U(x)$ , where  $V' = \{x \in X : \langle p, x \rangle = m\}$ . From assumption on  $U$  it follows that a local maximum is also a global one. The associated Lagrange function is here

$$L(x, \lambda) = U(x) + \lambda(m - \langle p, x \rangle).$$

The necessary condition of first order is  $U_{x_j} - \lambda^0 p_j = 0$  for each  $j = 1, \dots, n$ ,  $\lambda^0 \in \mathbb{R}$ . Hence  $\lambda^0 > 0$  since  $U_{x_j} > 0$ . The vector  $x^0$  is a strict local maximizer if

$$\langle L''(x^0, \lambda^0)z, z \rangle < 0$$

for all  $z \in \mathbb{R}^n \setminus \{0\}$  satisfying  $\langle p, z \rangle = 0$ . This equation is  $\langle g'(x), z \rangle = 0$ , where the side condition is given by  $g(x) \equiv \langle p, x \rangle - m = 0$ . Or, equivalently,

$$\langle U''(x^0)z, z \rangle < 0 \forall z \in \mathbb{R}^n, z \neq 0 \text{ and } \langle U'(x^0), z \rangle = 0.$$

The previous equation follows from the necessary condition of first order. Consider the system  $U'(x^0) - \lambda^0 p = 0$ ,  $\langle p, x^0 \rangle - m = 0$  of  $n + 1$  equations, then it follows from the necessary condition of first order and the above sufficient condition that the matrix

$$\begin{pmatrix} U''(x^0) & p \\ p^T & 0 \end{pmatrix},$$

where  $p$  is a column vector and  $p^T$  its transposed, is regular (Exercise). From the implicit function theorem it follows that there exists continuously differentiable demand functions  $x_i = f^i(p, m)$  and a continuously function  $\lambda^0 = f(p, m)$ ,  $|p - p_0| < \delta$ ,  $|m - m_0| < \delta$ ,  $\delta > 0$  sufficiently small, where  $(x^0, \lambda_0)$  is a solution of  $U'(x) - \lambda p^0 = 0$  and  $\langle p^0, x \rangle = m_0$ .



### 2.5.2 $V$ is a polyhedron

Suppose that  $f \in C^2$  and that  $V$  is given by

$$V = \{y \in \mathbb{R}^n : \langle l_i, y \rangle \leq a_i, i = 1, \dots, m\},$$

where  $\langle l_i, y \rangle := \sum_{k=1}^n l_{ik} y_k$ ,  $l_{ik} \in \mathbb{R}$ , are given linear functionals. Assume  $x \in V$  is a solution of the variational inequality  $\langle f'(x), y - x \rangle > 0$  for all  $y \in V$ , (or equivalently of the corresponding Lagrange multiplier equation). Define the cone

$$K = \{y \in \mathbb{R}^n; \langle l_i, y \rangle \leq 0 \text{ for each } i = 1, \dots, m \text{ and } \langle f'(x), y \rangle = 0\}.$$

Suppose that  $K = \{0\}$  or, if  $K \neq \{0\}$ , that  $\lambda_1 > 0$ , where

$$\lambda_1 = \min_{y \in K \setminus \{0\}} \frac{\langle f''(x)y, y \rangle}{\langle y, y \rangle},$$

then  $x$  is a strict local minimizer of  $f$  in  $V$ . If  $\lambda_1 < 0$ , then  $x$  is no local minimizer. Equivalently,  $x$  is a strict local minimizer if  $K = \{0\}$  or if the lowest eigenvalue of the variational inequality

$$w \in K : \langle f''(x)w, z - w \rangle \geq \lambda \langle w, z - w \rangle \text{ for all } z \in K$$

is positive.

### 2.5.3 Eigenvalue equations

Consider the eigenvalue equation  $Ax = \lambda Bx$ , where  $A$  and  $B$  are real and symmetric matrices with  $n$  rows (and  $n$  columns).

To illustrate the Lagrange multiplier method in the case of equations as side conditions, we will prove the following well known result.

Assume  $B$  is positive definite, then there exists  $n$  eigenvalues  $\lambda_1 \leq \lambda_2 \leq \dots \leq \lambda_n$  such that the associated eigenvectors  $x^{(k)}$  are  $B$ -orthogonal, that is  $\langle Bx^{(k)}, x^{(l)} \rangle = 0$  if  $k \neq l$ . The  $k$ -th eigenvalue is given by

$$\lambda_k = \min \frac{\langle Ay, y \rangle}{\langle By, y \rangle},$$

where the minimum is taken over  $y \neq 0$  which satisfy  $\langle Bx^{(l)}, y \rangle = 0$  for all  $l$ ,  $1 \leq l \leq k - 1$ .

*Proof.* Set

$$f(y) := \frac{1}{2}\langle Ay, y \rangle, \quad g(y) := \frac{1}{2}\langle By, y \rangle.$$

*Step 1.* We consider the problem to minimize  $f(y)$  under the side condition  $g(y) = 1$ . There exists a minimizer  $x^{(1)}$ . The vector  $x^{(1)}$  is a regular point since  $Bx^{(1)} \neq 0$  which follows since  $B$  is positive definite. Then Lagrange multiplier rule implies that there exists an eigenvalue  $\lambda_1$  and that  $x^{(1)}$  is an associated eigenvector. Since  $\langle Ax^{(1)}, x^{(1)} \rangle = \lambda_1 \langle Bx^{(1)}, x^{(1)} \rangle$  it follows that  $\lambda_1 = \min(1/2)\langle Ay, y \rangle$  under the side condition  $(1/2)\langle By, y \rangle = 1$ .

*Step 2.* We consider the problem to minimize  $f(y)$  under the side conditions  $g(y) = 1$  and  $\langle g'(x^{(1)}), y \rangle = 0$ . We recall that  $g'(y) \equiv By$ . By the same reasoning as above we find a minimizer  $x^{(2)}$  which is a regular vector since  $Bx^{(1)}$  and  $Bx^{(2)}$  are linearly independent (Exercise). Then there exists  $\lambda_2, \mu \in \mathbb{R}^n$  such that

$$Ax^{(2)} = \lambda_2 Bx^{(2)} + \mu Bx^{(1)}.$$

By (scalar) multiplying with  $x^{(1)}$  we obtain that  $\mu = 0$ , and by multiplying with  $x^{(2)}$  we see that  $\lambda_2 = \min(1/2)\langle Ay, y \rangle$  under the side conditions  $(1/2)\langle By, y \rangle = 1, \langle Bx^{(1)}, y \rangle = 0$ , which implies that  $\lambda_1 \leq \lambda_2$  is satisfied.

*Step 3.* Assume  $x^{(k)}, k \leq n$ , is a minimizer of the problem  $\min f(y)$  under the side conditions  $g(y) = 1, \langle g'(x^{(1)}), y \rangle = 0, \dots, \langle g'(x^{(k-1)}), y \rangle = 0$ , where  $Bx^{(1)}, \dots, Bx^{(k-1)}$  are linearly independent and  $\langle Bx^{(l)}, x^{(m)} \rangle = 0$  if  $l \neq m$ . Then there exists  $\lambda_k, \mu_1, \dots, \mu_{k-1}$  such that

$$Ax^{(k)} = \lambda_k Bx^{(k)} + \sum_{l=1}^{k-1} \mu_l Bx^{(l)}.$$

From the side conditions it follows that the multipliers  $\mu_l$  are zero. Moreover,  $\lambda_k = \min(1/2)\langle Ay, y \rangle$ , where the minimum is taken over

$$\{y \in \mathbb{R}^n; \frac{1}{2}\langle By, y \rangle = 1, \langle Bx^{(l)}, y \rangle = 0, l = 1, \dots, k-1\}.$$

Thus we obtain  $n$  linearly independent eigenvectors  $x^{(l)}, l = 1, \dots, n$ , which satisfy  $\langle Bx^{(k)}, x^{(l)} \rangle = 2\delta_{kl}$ , where  $\delta_{kl}$  denotes the Kronecker symbol defined by  $\delta_{kl} = 1$  if  $k = l$  and  $\delta_{kl} = 0$  if  $k \neq l$ . The associated eigenvalues satisfy the inequalities  $\lambda_1 \leq \lambda_2 \leq \dots \leq \lambda_n$ .

*Another proof.* Exploiting the special structure of the problem, we can prove the above proposition more directly without relying on the Lagrange

multiplier rule. Let  $x^{(k)}$  be a minimizer of the problem  $\min f(y)$  under the side conditions  $g(y) = 1$ , and  $\langle g'(x^{(l)}), y \rangle = 0$ ,  $1 \leq l \leq k-1$ , where  $x^{(l)}$  are mutually  $B$ -orthogonal, that is,  $\langle Bx^{(l)}, x^{(k)} \rangle = 2\delta_{lk}$ , and suppose that  $Ax^{(l)} = \lambda_l Bx^{(l)}$ ,  $1 \leq l \leq k-1$ . Equivalently,  $x^{(k)}$  is a solution of

$$\min \frac{\langle Ay, y \rangle}{\langle By, y \rangle} =: \lambda_k,$$

where the minimum is taken over all  $y \neq 0$  which satisfy the side conditions  $\langle g'(x^{(l)}), y \rangle = 0$ ,  $1 \leq l \leq k-1$ . We will show that  $x^{(k)}$  is an eigenvector to the eigenvalue  $\lambda = \lambda_k$ . Set for  $\epsilon$ ,  $|\epsilon| < \epsilon_0$ ,  $\epsilon_0$  sufficiently small,

$$h(\epsilon) = \frac{\langle A(x^{(k)} + \epsilon y), x^{(k)} + \epsilon y \rangle}{\langle B(x^{(k)} + \epsilon y), x^{(k)} + \epsilon y \rangle},$$

where  $y$  is a fixed vector satisfying the side conditions

$$\langle g'(x^{(l)}), y \rangle = 0, \quad 1 \leq l \leq k-1. \quad (2.6)$$

Then  $h(0) \leq h(\epsilon)$ , which implies that  $h'(0) = 0$  or

$$\langle Ax^{(k)}, y \rangle = \lambda_k \langle Bx^{(k)}, y \rangle \quad (2.7)$$

for all  $y$  which satisfy the above side conditions (2.6). It remains to show that (2.7) is true for all  $y \in \mathbb{R}^n$ . Set  $Z = \text{span} \{x^{(1)}, \dots, x^{(k-1)}\}$ . Then  $\mathbb{R}^n = Z \oplus Z^\perp$ , where the orthogonal decomposition is taken with respect to the scalar product  $\langle Bx, y \rangle$ . For  $y \in \mathbb{R}^n$  we have the decomposition  $y = \sum_{l=1}^{k-1} c_l x^{(l)} + w$ ,  $c_l \in \mathbf{R}$ ,  $w \in Z^\perp$ . We must show that

$$\langle Ax^{(k)}, \sum_{l=1}^{k-1} c_l x^{(l)} + w \rangle = \lambda_k \langle Bx^{(k)}, \sum_{l=1}^{k-1} c_l x^{(l)} + w \rangle$$

holds. Since  $w$  satisfies the side condition (2.6) we have

$$\langle Ax^{(k)}, w \rangle = \lambda_k \langle Bx^{(k)}, w \rangle.$$

If  $1 \leq l \leq k-1$ , then

$$\langle Bx^{(k)}, x^{(l)} \rangle = \langle Bx^{(l)}, x^{(k)} \rangle = 0 \quad (2.8)$$

since  $x^{(k)}$  satisfies the side conditions (2.6) and since  $B$  is symmetric. It remains to show that  $\langle Ax^{(k)}, x^{(l)} \rangle = 0$ . On the other hand, we have for  $1 \leq l \leq k-1$  the equations  $\lambda_l \langle Bx^{(l)}, y \rangle = \langle Ax^{(l)}, y \rangle$  are satisfied for all

$y \in \mathbb{R}^n$ . It follows, in particular, that  $\lambda_l \langle Bx^{(l)}, x^{(k)} \rangle = \langle Ax^{(l)}, x^{(k)} \rangle$  which implies that  $\lambda_l \langle Bx^{(k)}, x^{(l)} \rangle = \langle Ax^{(k)}, x^{(l)} \rangle = 0$ , because of equation (2.8) and since the matrices  $A$ ,  $B$  are symmetric.

As a corollary to the above theorem we obtain the maximum-minimum principle of Courant. The advantage of this principle is that we can define the eigenvalue  $\lambda_k$  without the knowledge of the eigenvectors  $x^{(1)}, \dots, x^{(k-1)}$ . For given  $k-1$  vectors  $z^{(l)} \in \mathbb{R}^n$  set

$$V_{k-1} \equiv V(z^{(1)}, \dots, z^{(k-1)}) : = \{y \in \mathbb{R}^n : \frac{1}{2} \langle By, y \rangle = 1, \\ \langle Bz^{(l)}, y \rangle = 0, l = 1, \dots, k-1\}$$

and

$$\Lambda_k(z^{(1)}, \dots, z^{(k-1)}) := \min_{V_{k-1}} \frac{1}{2} \langle Ay, y \rangle .$$

□

**Maximum-minimum principle of Courant.** *The  $k$ -th eigenvalue  $\lambda_k$  is given by*

$$\lambda_k = \max \Lambda_k(z^{(1)}, \dots, z^{(k-1)}) ,$$

where the maximum is taken over all  $(k-1)$ -tuples of vectors  $z^{(1)}, \dots, z^{(k-1)}$ .

*Proof.* Set  $z^{(1)} = x^{(1)}, \dots, z^{(k-1)} = x^{(k-1)}$ , where  $x^{(l)}$  denotes the above eigenvector to the eigenvalue  $\lambda_l$ . Then

$$\min \frac{1}{2} \langle Ay, y \rangle = \lambda_k ,$$

where the minimum is taken over  $V(x^{(1)}, \dots, x^{(k-1)})$ . That is,

$$\lambda_k \leq \sup_{z^{(1)}, \dots, z^{(k-1)}} \Lambda_k(z^{(1)}, \dots, z^{(k-1)}) .$$

On the other hand, let  $\hat{x} := \sum_{l=1}^k c_l x^{(l)}$ , where we choose coefficients  $c_l$  such that  $\frac{1}{2} \langle B\hat{x}, \hat{x} \rangle = 1$ , that is,  $\sum_{l=1}^k c_l^2 = 1$  and  $\langle Bz^{(l)}, \hat{x} \rangle = 0$ ,  $l = 1, \dots, k-1$ , for fixed vectors  $z^{(1)}, \dots, z^{(k-1)}$ . Then

$$\Lambda_k(z^{(1)}, \dots, z^{(k-1)}) \leq \frac{1}{2} \langle A\hat{x}, \hat{x} \rangle = \sum_{l=1}^k c_l^2 \lambda_l \leq \lambda_k \sum_{l=1}^k c_l^2 = \lambda_k .$$

Consequently,

$$\sup_{z^{(1)}, \dots, z^{(k-1)}} \Lambda_k(z^{(1)}, \dots, z^{(k-1)}) \leq \lambda_k .$$

Since  $\lambda_k = \Lambda_k(x^{(1)}, \dots, x^{(k-1)})$ , we can replace sup by min. □

### 2.5.4 Unilateral eigenvalue problems

Discretization of some obstacle problems in mechanics lead to the following type of problems. Let  $A$  and  $B$  be real and symmetric matrices with  $n$  rows (and  $n$  columns). Set as above

$$f(y) = \frac{1}{2}\langle Ay, y \rangle, \quad g(y) = \frac{1}{2}\langle By, y \rangle, \quad y \in \mathbb{R}^n,$$

and assume that the matrix  $B$  is positive definite and that the set of admissible vectors is given by

$$V = \{y \in \mathbb{R}^n : a_i \leq y_i \leq b_i, \quad i = 1, \dots, n\},$$

where  $a_i \in [-\infty, \infty)$  and  $b_i \in (-\infty, \infty]$  are given and satisfy  $a_i < b_i$  for each  $i$ . If  $a_k = -\infty$ , then we suppose that  $y_i$  satisfies the inequality  $-\infty < y_k$ , if  $b_k = \infty$ , then  $y_k < \infty$ , respectively. The set  $V$  is a closed convex subset of  $\mathbb{R}^n$ . Then we consider the eigenvalue problem

$$x \in V : \quad \langle Ax, y - x \rangle \geq \lambda \langle Bx, y - x \rangle \quad \text{for all } y \in V, \quad (2.9)$$

i. e., we seek a  $\lambda \in \mathbb{R}$  such that (2.9) has a solution  $x \neq 0$ .

The constrained minimum problem

$$\min_{y \in M_s} f(y), \quad (2.10)$$

where  $M_s = \{y \in V; g(y) = s\}$  for a given  $s > 0$ , is closely related to the variational inequality (2.9) and vice versa. If  $x$  is a regular point with respect to the side condition  $g(y) = s$  and the side conditions which define  $V$ , then there exists  $\lambda_0, \lambda_j \in \mathbb{R}$  such that

$$Ax = \lambda_0 Bx - \sum_{j \in I_0} \lambda_j e^j, \quad (2.11)$$

where  $e^j = (0, \dots, 0, 1, 0, \dots, 0)$  denotes the vectors of the standard basis in  $\mathbb{R}^n$ , and  $I_0$  denotes the set of indices where the constraints which define  $V$  are active. One has  $\lambda_j \geq 0$  if  $x_j = b_j$  and  $\lambda_j \leq 0$  if  $x_j = a_j$ .

One finds easily that  $x$  is a regular point if and only if at least one coordinate of  $Bx$  with an index  $k \notin I_0$  is not zero (exercises).

Thus we have shown

*Assume that a solution  $x$  of the minimum problem (2.10) satisfies  $\langle Bx, e^k \rangle \neq 0$  for a  $k \notin I_0$ , then there exists  $\lambda_0, \lambda_j \in \mathbb{R}$ ,  $j \in I_0$ , such that the Lagrange multiplier rule holds, where  $\lambda_j \geq 0$  if  $x_j = b_j$  and  $\lambda_j \leq 0$  if  $x_j = a_j$ .*

Another useful observation is that

*the variational inequality (2.9) and the Lagrange multiplier equation (2.11) are equivalent.*

*Proof.* (i) Assume  $x \in V : \langle Ax, y - x \rangle \geq \lambda_0 \langle Bx, y - x \rangle$  for all  $y \in V$ . Set  $I = \{1, \dots, n\}$  and  $I_0^a = \{i \in I : x_i = a_i\}$ ,  $I_0^b = \{i \in I : x_i = b_i\}$ . The variational inequality implies that  $(Ax)_i = \lambda_0 (Bx)_i$  if  $i \in I \setminus (I_0^a \cup I_0^b)$ ,  $(Ax)_i \geq \lambda_0 (Bx)_i$  if  $i \in I_0^a$ ,  $(Ax)_i \leq \lambda_0 (Bx)_i$  if  $i \in I_0^b$ . One can write these inequalities as equation (2.11) with appropriate  $\lambda_j$ .

(ii) Multiplying the Lagrange multiplier equation (2.11) with  $y - x$ , we obtain

$$\langle Ax, y - x \rangle - \lambda_0 \langle Bx, y - x \rangle = - \sum_{j \in I_0^a} \lambda_j \langle e^j, y - x \rangle - \sum_{j \in I_0^b} \lambda_j \langle e^j, y - x \rangle \geq 0$$

since  $\lambda_j \leq 0$ ,  $\langle e^j, y - x \rangle \geq 0$  if  $j \in I_0^a$  and  $\lambda_j \geq 0$ ,  $\langle e^j, y - x \rangle \leq 0$  if  $j \in I_0^b$ .  $\square$

Now we consider the question whether a solution  $(x, \lambda_0) \in V \times \mathbb{R}$ ,  $x \neq 0$ , of the variational inequality (2.9) or, equivalently, of the Lagrange multiplier equation (2.11) defines a strict local minimum of the functional

$$F(y, \lambda_0) := f(y) - \lambda_0 g(y) \equiv \frac{1}{2} \langle Ay, y \rangle - \frac{\lambda_0}{2} \langle By, y \rangle$$

in  $V = \{y \in \mathbb{R}^n; a_i \leq y_i \leq b_i\}$ .

The phenomenon that an eigenvector defines a strict local minimum of the associated functional  $F(y, \lambda_0)$  is due to the side conditions. There is no such behaviour in the unconstrained case. In this case we have

$$\begin{aligned} F(x + y, \lambda_0) &= F(x, \lambda_0) + \langle F'(x, \lambda_0), y \rangle + \frac{1}{2} \langle F''(x, \lambda_0)y, y \rangle \\ &= F(x, \lambda_0) + \frac{1}{2} \langle F''(x, \lambda_0)y, y \rangle \\ &= F(x, \lambda_0) + \langle Ay - \lambda_0 By, y \rangle . \end{aligned}$$

Set  $y = \epsilon x$ ,  $\epsilon \neq 0$ , then we obtain  $F(x + \epsilon x, \lambda_0) = F(x, \lambda_0)$ . Thus  $x$  is no strict local minimizer of  $F(y, \lambda_0)$ .

In our example, the tangent cone  $T(V, x)$  is given by

$$T(V, x) = \{y \in \mathbb{R}^n : y_j \leq 0 \text{ if } x_j = b_j \text{ and } y_j \geq 0 \text{ if } x_j = a_j\}.$$

Let  $I_0^\pm = \{j \in I_0 : \lambda_j \neq 0\}$ , where the  $\lambda_j$  are the multipliers in formula (2.11), and set

$$T_0 = \{z \in T(V, x) : z_j = 0 \text{ if } j \in I_0^\pm\}.$$

It follows from the sufficient criterion Theorem 2.3.3 that  $(x, \lambda_0)$  defines a strict local minimum of  $F(y, \lambda_0)$  if  $T_0 = \{0\}$  or if  $A - \lambda_0 B$  is positive on  $T_0 \setminus \{0\}$ , i. e., if  $\langle (A - \lambda_0 B)z, z \rangle > 0$  for all  $z \in T_0 \setminus \{0\}$ .

### 2.5.5 Noncooperative games

Noncooperative games are games without binding agreements between the players. A noncooperative game consists of

- (i) A set of  $n$  players  $N = \{1, 2, \dots, n\}$ .
- (ii) A collection of nonempty strategy sets  $S_i$ , where  $S_i$  is the strategy set of the  $i$ -th player and a subset of a Euclidean space, say of  $\mathbb{R}^{m_i}$ . The set  $S = S_1 \times S_2 \times \dots \times S_n$  is the strategy set of the game and an element  $s_i \in S_i$  is a strategy for the player  $i$  and a point  $s = (s_1, s_2, \dots, s_n) \in S$  is a strategy of the game.
- (iii) A set of payoff functions  $f_i : S \rightarrow \mathbb{R}$ . The value  $f_i(s)$  is the payoff for the  $i$ -th player if the players choose the strategy  $s \in S$ .

We will denote such a game by  $\{S_i, f_i\}_{i \in N}$ . To formulate the concept of a Nash equilibrium we need some notations. Set  $S_{-i} = S_1 \times S_2 \times \dots \times S_{i-1} \times S_{i+1} \times \dots \times S_n$  and for a given strategy vector  $s = (s_1, s_2, \dots, s_n) \in S$  we define  $s_{-i} \in S_{-i}$  by  $s_{-i} = (s_1, s_2, \dots, s_{i-1}, s_{i+1}, \dots, s_n)$ . Finally, set  $s_{-i} \setminus t = (s_1, s_2, \dots, s_{i-1}, t, s_{i+1}, \dots, s_n)$ ,  $t \in S_i$ .

#### Example: Oligopoly

An oligopoly consists of  $n$  firms producing identical common products. Firm  $i$  has a cost function  $c_i(q_i)$  where  $q_i$  is the amount of the product which this firm produces. The inverse demand is given by  $p(r)$ , where  $r = q_1 + q_2 + \dots + q_n$ . An inverse demand function is the inverse of the demand function which gives the amount of this product that consumers will buy as a function of its price. The players are the  $n$  firms. The player  $i$  chooses the strategy of his strategy set  $S_i = [0, M_i]$ , where  $M_i$  is the capacity of the  $i$ -th firm. The payoff function of the  $i$ -th firm is its profit

$$\pi_i(q) = p(q_1 + \dots + q_n)q_i - c_i(q_i).$$

A generalization of an oligopoly is a *monopolistic competition*. Let  $p_i = p_i(q_1, q_2, \dots, q_n)$  be the inverse demand function for the  $i$ -th firm. Then the payoff functions of a monopolistic competition are given by

$$\pi_i(q) = p(q_1, \dots, q_n)q_i - c_i(q_i).$$

**Definition.** A point  $s^* \in S$  is a *Nash equilibrium* of the game  $\{S_i, f_i\}_{i \in N}$  if for every  $i \in N$

$$f_i(s_{-i}^* \setminus s_i) \leq f_i(s^*) \quad \text{for all } s_i \in S_i.$$

To formulate the general existence result of Nash we define what *individually quasiconcave* means.

**Definition.** A function  $f : V \rightarrow \mathbb{R}$ , where  $V$  is a convex subset of  $\mathbb{R}^n$ , is said to be *quasiconcave* on  $V$  if  $x_1, x_2 \in V$  and  $f(x_1) \geq c$ ,  $f(x_2) \geq c$  implies that  $f(\lambda x_1 + (1 - \lambda)x_2) \geq c$  for all  $\lambda$ ,  $0 < \lambda < 1$ .

Each concave function is also quasiconcave, but there are quasiconcave functions which are not concave, see for example  $f(x) = -x^2 + 1$  on  $0 \leq x \leq 1$  and  $-x + 1$  on  $[1, \infty)$  which is quasiconcave on  $[0, \infty]$ .

**Definition.** The payoff function  $f_i$  is said to be *individually quasiconcave* if for each value  $s_{-i} \in S_{-i}$  the function  $f_i(s_{-i} \setminus t)$  is quasiconcave with respect to  $t \in S_i$ .

We recall that a function  $f$  is concave if  $-f$  is convex.

**Theorem** (Nash [46]). *Let  $\{S_i, f_i\}_{i \in N}$  be a noncooperative game. Suppose that the strategy sets  $S_i \subset \mathbb{R}^{m_i}$  are convex and compact and that the payoff functions  $f_i$  are continuous and individually quasiconcave. Then a Nash equilibrium exists.*

*Sketch of proof.* Define multivalued mappings  $\mu_i : S \mapsto S_i$  by

$$\mu_i(s) = \{x \in S_i : f_i(s_{-i} \setminus x) = \max_{y \in S_i} f_i(s_{-i} \setminus y)\}$$

and set  $\mu(s) = \prod_{i=1}^n \mu_i(s)$ . Then  $s^* \in S$  is a Nash equilibrium if and only if  $s^*$  is a fixed point of the multivalued mapping  $\mu$ , that is, if  $s^* \in \mu(s^*)$  holds.



The existence of such a fixed point follows from the fixed point theorem of Kakutani [27, 22].  $\square$

From this theorem it follows the existence of an equilibrium of an oligopoly or an monopolistic competition if the involved functions satisfy additional assumptions.

In generalization to local minimizers we define a local Nash equilibrium.

**Definition.** A point  $s^* \in S$  is a *local Nash equilibrium* for the game  $\{S_i, f_i\}_{i \in N}$  if there exists a  $\rho > 0$  such that for every  $i \in N$

$$f_i(s_{-i}^* \setminus s_i) \leq f_i(s^*) \quad \text{for all } s_i \in S_i \cap B_\rho(s_i^*),$$

where  $B_\rho(s_i^*)$  is a ball with center  $s_i^* \in S_i$  and radius  $\rho > 0$ .

From the above definition of a local equilibrium we obtain immediately a necessary condition for a local equilibrium. Set  $f_i, s_i(s) = \nabla_{s_i} f_i(s)$ ,  $s_i$  has  $m_i$  coordinates  $s_i = (s_i^1, \dots, s_i^{m_i})$ . Then:

*Suppose that  $f_i \in C^1$  and that  $s^*$  defines a local equilibrium. Then for every  $i \in N = \{1, \dots, n\}$*

$$\langle f_{i,s_i}(s^*), w \rangle \leq 0 \quad \text{for all } w \in T(S_i, s_i^*).$$

Sufficient conditions follow from the results of Section 2.3. To simplify the considerations assume that each  $S_i \subset \mathbb{R}^{m_i}$  is a parallelepiped  $S_i = \{x \in \mathbb{R}^{m_i}; a_i^k \leq x_i^k \leq b_i^k, k = 1, \dots, m_i\}$ . Define

$$f_{i,s_i}^\perp(s^*) = \{y \in \mathbb{R}^{m_i} : \langle f_{i,s_i}(s^*), y \rangle = 0\}$$

and

$$\lambda_i = \max_y \langle f_{i,s_i,s_i}(s^*)y, y \rangle,$$

where the maximum is taken over  $y \in T(S_i, s_i^*) \cap f_{i,s_i}^\perp(s^*)$  which satisfy  $\langle y, y \rangle = 1$ . In the case that  $T(S_i, s_i^*) \cap f_{i,s_i}^\perp(s^*) = \{0\}$  we set  $\lambda_i = -\infty$ .

From Section 2.3 we obtain the following sufficient condition:

Assume the payoff functions  $f_i \in C^2$  and that  $s^*$  satisfies the necessary conditions. If  $\lambda_i < 0$  for every  $i$ , then  $s^*$  defines a local equilibrium. If  $\lambda_i > 0$  for at least one  $i$ , then  $s^*$  defines no equilibrium.

Let  $S_i$  be the interval  $a_i \leq y \leq b_i$ . Then

$$f_{i,s_i}^\perp(s^*) = \{y \in \mathbb{R} : f_{i,s_i}(s^*)y = 0\} = \begin{cases} \mathbb{R} & \text{if } f_{i,s_i}(s^*) = 0 \\ \{0\} & \text{if } f_{i,s_i}(s^*) \neq 0 \end{cases} .$$

The necessary conditions of first order are

$$f_{i,s_i}(s^*)(y - s_i^*) \leq 0 \quad \text{for all } y \in S_i .$$

Let  $N_1, N_2 \subseteq N$  be defined as follows:  $i \in N_1$  if  $f_{i,s_i}(s^*) \neq 0$  and  $i \in N_2$  if  $f_{i,s_i}(s^*) = 0$ . Then  $s^*$  defines a local equilibrium if  $f_{i,s_i,s_i}(s^*) < 0$  for every  $i \in N_2$ , and  $s^*$  is no equilibrium if  $f_{i,s_i,s_i}(s^*) > 0$  for at least one  $i \in N_2$ .

## 2.5.6 Exercises

1. Show that the matrix, see Section 2.4.1,

$$\begin{pmatrix} U''(x^0) & p \\ p^T & 0 \end{pmatrix}$$

is regular.

2. Set

$$V = \{y \in \mathbb{R}^n : a_j \leq y_j \leq b_j, j = 1, \dots, n\},$$

where  $a_j < b_j$ . Suppose that  $\lambda_0$  is an eigenvalue of the variational inequality

$$x \in V : \langle Ax, y - x \rangle \geq \lambda \langle Bx, y - x \rangle \text{ for all } y \in V.$$

Show that  $\lambda_0 > 0$  holds, provided that the real matrices  $A$  and  $B$  are symmetric and positive, and that  $a_j \leq 0 \leq b_j$  for all  $j$ .

*Hint:* The variational inequality is equivalent to the Lagrange rule (2.11).

3. Let

$$A = \begin{pmatrix} 2 & -1 & 0 \\ -1 & 2 & -1 \\ 0 & -1 & 2 \end{pmatrix}, \quad B = \begin{pmatrix} 1 & 0 & 0 \\ 0 & 1 & 0 \\ 0 & 0 & 1 \end{pmatrix}.$$

and  $V = \{y \in \mathbb{R}^3; y_i \leq 1, i = 1, 2, 3\}$ .

- (a) Show that  $x = (1, 1, 1)$  is an eigenvector to *each* eigenvalue  $\lambda_0 \in [1, \infty)$  of the variational inequality

$$x \in V : \langle Ax, y - x \rangle \geq \lambda \langle Bx, y - x \rangle \text{ for all } y \in V.$$

- (b) Show that  $x = (a, 1, a)$ ,  $0 < a < 1$ , is an eigenvector to the eigenvalue  $\lambda = 2 - (1/a)$  if  $a$  satisfies  $1/\sqrt{2} \leq a < 1$ .

- (c) Show that  $x = (1, a, 1)$ ,  $0 < a < 1$ , is no eigenvector.

*Hint:* Use that the inequality is equivalent to a Lagrange multiplier rule.

4. Under which conditions on  $a$  define the eigenvectors and associated eigenvalues of the previous exercise a strict local minimum of  $f(y) = \langle Ay, y \rangle - \lambda \langle By, y \rangle$  in  $V$ ?

*Hint:* Use Theorem 2.3.3 (sufficient criterion).

5. Show that a local equilibrium  $s^*$  satisfies a system of  $\sum_{i=1}^n m_i$  equations if  $s^*$  is an interior point of  $S$ .

6. Let

$$\begin{aligned} f_1(s) &= 2\,720\,000 s_1 - 33\,600 s_1 s_2 - s_1^4, \\ f_2(s) &= 2\,720\,000 s_2 - 33\,600 s_1 s_2 - s_2^4 \end{aligned}$$

and  $S_1 = S_2 = [-100, 90]$ . Show that  $s^* = (-42.3582, 90)$  defines a local equilibrium.

7. Consider the case  $n = 2$  for an oligopoly, that is, a duopoly. Find conditions under which Nash equilibria are no interior points.

8. Suppose that the oligopoly has a linear demand function, that is,  $p(r)$ ,  $r = \sum_i^n q_i$  is given by

$$p(r) = \begin{cases} a - br & \text{if } 0 \leq r \leq a/b \\ 0 & \text{if } r > a/b \end{cases},$$

where  $a$  and  $b$  are given positive constants. Assume that the cost functions are linear, then the payoff functions are given by

$$\pi_i(q) = p(r)q_i - c_i q_i, \quad r := \sum_{k=1}^n q_k.$$

Show that these payoff functions are continuous and individually quasi-concave. Consequently there exists a Nash equilibrium of this oligopoly.

9. Consider the previous example. Find conditions under which Nash equilibria are no interior points.

10. Let  $V = \{y \in \mathbb{R}^n : y_i \leq 1, i = 1, \dots, n\}$  and set

$$A = \begin{pmatrix} 2 & -1 & 0 & 0 & \dots \\ -1 & 2 & -1 & 0 & \dots \\ 0 & -1 & 2 & -1 & \dots \\ \dots & \dots & \dots & \dots & \dots \end{pmatrix}.$$

Apply the projection-iteration method

$$x^{k+1} = p_V(x^k - q(Ax^k - \lambda x^k))$$

of Section 2.2 to find eigenvectors of the variational inequality

$$x \in V : \langle Ax - \lambda x, y - x \rangle \geq 0 \text{ for all } y \in V$$

which are no eigenvectors of the associated eigenvalue equation.

*Hint:* Type "alg" after loading the following Mathematica program and you will get some  $x^k$ .

```
n:=10
run:=20
q:=0.5
m:=1/(n+1)^2 ev
o:=6
ev:=20
pr[z_]:=Table[Which[z[[k]]>1,1,True,z[[k]],{k,n}]
g[x_,m_]:=q (a.x-m b.x)
alg:={x=x0;Do[Print[x];x=pr[x-g[x,m]],{run}]}
a:=Table[Switch[i-j,-1,-1,0,2,1,-1,-,0],{i,n},{j,n}]
b:=IdentityMatrix[n]
x0:=Flatten[Join[Table[0.5,{k,n-o}],Table[1,{k,2 o-n}],Table[0.5,{k,n-o}]]]
```

*Remark.* The above problem comes from a difference approximation of the unilateral eigenvalue problem

$$u \in V : \int_a^b u'(x)(v(x) - u(x))' dx \geq \lambda \int_a^b u(x)(v(x) - u(x)) dx$$

for all  $v \in V$ , where  $V = \{v \in H_0^1(a, b) : v(x) \leq 1 \text{ on } (a, b)\}$ .

11. Let  $A$  and  $V$  be the same as in the previous exercise. Find eigenvectors of the variational inequality

$$x \in V : \langle A^2x - \lambda Ax, y - x \rangle \geq 0 \text{ for all } y \in V$$

which are no eigenvectors of the associated eigenvalue equation.

*Hint:* Type "alg" after loading the following Mathematica program and you will get some  $x^k$ .

```

n:=20
run:=20
q:=0.1
m:=1/(n+1)^2 ev
o:=15
ev:=40
pr[z_]:=Table[Which[z[[k]]>1,1,True,z[[k]]],{k,n}]
g[x_,m_]:=q ((a.a).x-m a.x)
alg:={x=x0;Do[Print[x];x=pr[x-g[x,m]],{run}]}
a:=Table[Switch[i-j,-1,-1,0,2,1,-1,-,0],{i,n},{j,n}]
x0:=Flatten[Join[Table[0.5,{k,n-o}],Table[1,{k,2 o-n}],Table[0.5,{k,n-
o}]]]

```

*Remark.* The above problem comes from a difference approximation of the unilateral eigenvalue problem

$$u \in V : \int_a^b u''(x)(v(x) - u(x))'' dx \geq \lambda \int_a^b u'(x)(v(x) - u(x))' dx$$

for all  $v \in V$ , where  $V = \{v \in H^2(a, b) \cap H_0^1(a, b) : v(x) \leq 1 \text{ on } (a, b)\}$ .

12. Consider an oligopol with payoff functions

$$f_i(x, y) = y_i(a - b \sum_{k=1}^n y_k x_k) x_i - c_i y_i x_i.$$

Let the strategy set of the  $i$ -th firm be  $0 \leq x_i \leq 1$ , the capacity bound of the  $i$ -th firm is given by a positive constant  $y_i$ , and  $a, b$  are positive constants. Set

$$g_i(x, y) = -f_{i, x_i}(x, y)$$

and  $V = [0, 1]^n$ . Then a necessary condition that  $x^*$  defines a local Nash equilibrium is

$$x^* : \langle g(x^*, y), x - x^* \rangle \geq 0 \text{ for all } x \in V.$$

Apply the projection-iteration method  $x^{k+1} = p_V(x^k - qg(x^k, y))$ ,  $0 < q < \infty$ , of Section 2.2 to find local Nash equilibria of an example of the above oligopol, i. e., for given data  $a, b, c_i$  and  $y_i$ .

*Remark.* According to the above sufficient criterion,  $x^*$  defines a local Nash equilibrium if  $f_{i,x_i,x_i}(x^*, y) < 0$  for all  $i$  where  $f_{i,x_i}(x^*, y) = 0$ . In this example we have  $f_{i,x_i,x_i} = -2by_i^2$ . Thus  $x^*$  is a local Nash equilibrium since  $y_i > 0$ .

*Hint:* Type "alg" after loading the following Mathematica program and you will get some  $x^k$ . Then type "test" and you will see whether or not the final  $x^k$  defines a local Nash equilibrium.

```
n:=5
m:=5
run:=10
q:=0.03
pr[z_]:=Table[Which[z[[k]]<0,0,z[[k]]>1,1,True,z[[k]]],{k,n}
g[x_,y_-]:=-q Table[f1[x,y][[k]],{k,n}
alg:={x=x0;Do[Print[x];x=pr[x-g[x,y]],{run}]}
test:=Table[Which[-0.05<f1[x,y][[k]]<0.05,f2[x,y][[k]],True,un],{k,n}
f1[x_,y_-]:=Table[N[y[[i]] (a-b Sum[y[[k]] x[[k]],{k,n})-b y[[i]]^2
x[[i]]-c[[i]] y[[i]]],{i,n}
f2[x_,y_-]:=Table[N[-2 b y[[k]]^2],{k,n}
a:=10
b:=1
c:=Table[1,{i,n}
x0:=Table[N[1/(b (n+1)) (a-(n+1) c[[i]]+Sum[c[[k]],{k,n})]],{i,n}
y0:=-0.2
y:=x0+Flatten[Join[{y0},Table[1,{i,m-1}]]]
```

13. Consider the oligopoly of the previous exercise but with the additional side condition

$$\sum_{k=1}^n y_k x_k \leq \frac{a}{b}.$$

Then the strategy set of the  $i$ -th firm is

$$S_i(x) = \left\{ 0 \leq x_i \leq 1 : 0 \leq x_i \leq \frac{1}{y_i} \left( \frac{a}{b} - \sum_{k=1}^n y_k x_k + y_i x_i \right) \right\},$$

- i. e., in fact  $S_i(x)$  does not depend on  $x_i$ . Set

$$V(x) = S_1(x) \times \dots \times S_n(x).$$

Then we seek solutions of

$$x^* \in V(x^*) : \langle g(x^*, y), x - x^* \rangle \geq 0 \text{ for all } V(x^*).$$

This variational inequality is equivalent to the fixed point equation

$$x = p_{V(x)}(x - qg(x, y))$$

with a given positive constant  $q$ .

Find solutions  $x^*$ , for given data  $a$ ,  $b$ ,  $c_i$  and  $y_i$ , by using the iteration procedure

$$x^{k+1} = p_{V(x^k)}(x^k - qg(x^k, y)).$$

*Remark.* A problem where the strategy set of the  $i$ -th player depends on the strategy of the other players is called a *social system*, see [11].

*Hint:* Type "alg" after loading the following Mathematica program and you will get some  $x^k$ . Then type "test" and you will see whether or not the final  $x^k$  defines a local Nash equilibrium.

```

n:=5
m:=5
run:=10
q:=0.03
pr[z_,x_,y_]:=Table[Which[z[[k]]<0,0,z[[k]]>Min[1,(1/y[[k]]) ((a/b)-
Sum[y[[i]] x[[i]], {i,n})+ y[[k]] x[[k]] )],
Min[1,(1/y[[k]]) ((a/b)-Sum[y[[i]] x[[i]], {i,n})+
y[[k]] x[[k]] )],True,z[[k]]],{k,n}
g[x_,y_]:=-q Table[f1[x,y][[k]],{k,n}
alg:={x=x0;Do[Print[x];x=pr[x-g[x,y],x,y],{run}]}
test:=Table[Which[-0.05<f1[x,y][[k]]<0.05,f2[x,y][[k]],True,un],{k,n}
f1[x_,y_]:=Table[N[y[[i]] (a-b Sum[y[[k]] x[[k]],{k,n})-b y[[i]]^2
x[[i]]-c[[i]] y[[i]]],{i,n}
f2[x_,y_]:=Table[N[-2 b y[[k]]^2],{k,n}
a:=10
b:=1
c:=Table[1,{i,n}]
s0:=s
s:=0.5
x0:=Flatten[Join[{s0},Table[s,{i,n-1}]]]
y0:=1

```



```
y:= f Flatten[Join[{y0},Table[1,{i,m-1}]]]  
f:=1
```

## 2.6 Appendix: Convex sets

Some existence results for systems of linear inequalities as well as Lagrange multiplier rules for variational inequalities follow from separation theorems.

### 2.6.1 Separation of convex sets

Here we consider separations by hyperplanes. There is not always a separation by a hyperplane of two given sets, see Figure 2.4.

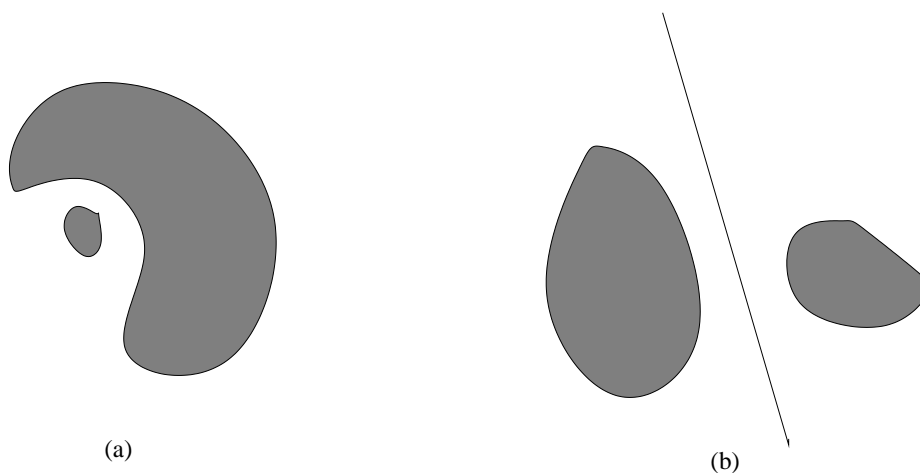

Figure 2.4: Separation of sets

**Definition.** For given  $p \in \mathbb{R}^n$ ,  $p \neq 0$ , and real  $\alpha$  the set

$$H(p, \alpha) = \{y \in \mathbb{R}^n : \langle p, y \rangle = \alpha\}$$

is called *hyperplane*.

**Definition.** A hyperplane  $H(p, \alpha)$  *separates* two nonempty sets  $A, B \subset \mathbb{R}^n$  if one of the two conditions is satisfied for a  $p \in \mathbb{R}^n$ ,  $p \neq 0$ , and a real  $\alpha$ :

(i)  $\langle p, y \rangle \leq \alpha$  for all  $y \in A$  and  $\langle p, y \rangle \geq \alpha$  for all  $y \in B$ ,

(ii)  $\langle p, y \rangle \geq \alpha$  for all  $y \in A$  and  $\langle p, y \rangle \leq \alpha$  for all  $y \in B$ .

A hyperplane  $H(p, \alpha)$  *separates strictly* two nonempty sets  $A, B \subset \mathbb{R}^n$  if one of the two conditions is satisfied for a  $p \in \mathbb{R}^n$ ,  $p \neq 0$ , and a real  $\alpha$ :

(i)  $\langle p, y \rangle < \alpha$  for all  $y \in A$  and  $\langle p, y \rangle > \alpha$  for all  $y \in B$ ,

(ii)  $\langle p, y \rangle > \alpha$  for all  $y \in A$  and  $\langle p, y \rangle < \alpha$  for all  $y \in B$ .

**Theorem 2.6.1** (Separation of a closed convex set and a point). *Let  $X \subset \mathbb{R}^n$  be nonempty, closed and convex, and  $z \notin X$ . Then there exists a hyperplane which separates  $X$  and  $z$  strictly.*

*Proof.* There exists a solution of

$$x \in X : \|z - x\|^2 \leq \|z - y\|^2 \text{ for all } y \in X,$$

see Figure 2.5 for an illustration. Replacing  $y$  by  $x + \lambda(y - x)$ ,  $0 \leq \lambda \leq 1$ ,

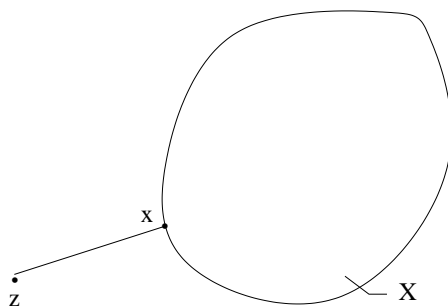

Figure 2.5: Projection of  $z$  onto  $X$

implies that

$$x \in X : \langle x - z, y - x \rangle \geq 0 \text{ for all } y \in X.$$

Set  $p = x - z$  and  $\alpha = \langle x - z, x \rangle$ , then  $\langle p, y \rangle \geq \alpha$  for all  $y \in X$ .

Inequality  $\langle p, z \rangle < \alpha$  holds since

$$\begin{aligned} \langle p, z \rangle &= \langle x - z, z \rangle \\ &= -\langle x - z, x - z \rangle + \langle x - z, x \rangle \\ &= -\|x - z\|^2 + \alpha \\ &< \alpha. \end{aligned}$$

Then the hyperplane  $H(p, \alpha^*)$ , where  $\langle p, z \rangle < \alpha^* < \alpha$ , separates  $X$  and  $z$  strictly.  $\square$

**Definition.** A hyperplane  $H(p, \alpha)$  is called *supporting plane* of  $X$  at  $x$  if

$$\langle p, y \rangle \geq \alpha \text{ for all } y \in X \text{ and } \langle p, x \rangle = \alpha$$

or

$$\langle p, y \rangle \leq \alpha \text{ for all } y \in X \text{ and } \langle p, x \rangle = \alpha.$$

**Theorem 2.6.2** (Supporting plane of closed convex sets). *Suppose that  $X \subset \mathbb{R}^n$  is nonempty, closed, convex, and that the boundary  $\partial X$  is nonempty. Let  $x \in \partial X$ , then there exist a supporting plane of  $X$  at  $x$ .*

*Proof.* Let  $x \in \partial X$ . Then there exists a sequence  $x^k \notin X$  such that  $x^k \rightarrow x$  as  $k \rightarrow \infty$ . Without restriction of generality, we can assume, see Theorem 2.6.1, that there exists hyperplanes  $H(p^k, \alpha_k)$  such that

$$\langle p^k, y \rangle \geq \alpha_k \geq \langle p^k, x^k \rangle \text{ for all } y \in X.$$

Moreover we can assume that  $\|p^k\| = 1$  since

$$\left\langle \frac{p^k}{\|p^k\|}, y \right\rangle \geq \frac{\alpha_k}{\|p^k\|} \geq \left\langle \frac{p^k}{\|p^k\|}, x^k \right\rangle$$

for all  $y \in X$ . Thus  $H(p^k_*, \alpha_k^*)$ , where  $p^k_* = p^k / \|p^k\|$  and  $\alpha_k^* = \alpha_k / \|p^k\|$ , separate  $X$  and  $x^k$ . Choose a subsequence of  $x^k$  such that the associated subsequences  $p^k_*$  and  $\alpha_k^*$  converge, say to  $p$  and  $\alpha$ , respectively. It follows that

$$\langle p, y \rangle \geq \alpha \geq \langle p, x \rangle \text{ for all } y \in X.$$

These inequalities imply that  $\alpha = \langle p, x \rangle$  since  $x \in X$ . □

**Remark.** A supporting plane can be considered as a generalization of a tangent plane in the case that this plane does not exist, see Figure 2.6.

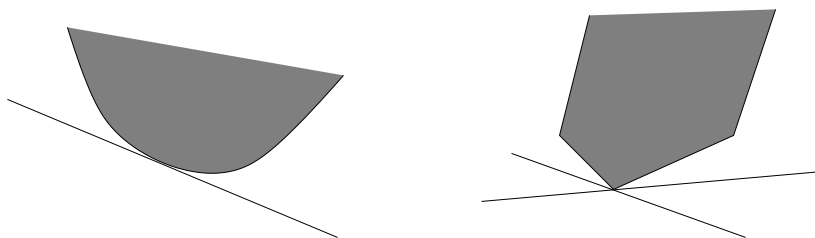

Figure 2.6: Supporting planes

**Theorem 2.6.3** (Separation of a point and a not necessarily closed convex set). *Suppose that  $X \subset \mathbb{R}^n$ , not necessarily closed, is nonempty, convex and that  $z \notin X$ . Then there exists a hyperplane which separates  $X$  and  $z$ .*

*Proof.* Assume  $z \notin \text{cl } X$ , where  $\text{cl } X$  denotes the closure of  $X$ . Then the assertion follows from Theorem 2.2.9. In the case that  $z \in \text{cl } X$  the theorem is a consequence of Theorem 2.2.10.  $\square$

This theorem implies the following more general result.

**Theorem 2.6.4** (Minkowski). *Suppose that  $X, Y \subset \mathbb{R}^n$ , not necessarily closed, are nonempty, convex and that  $X \cap Y = \emptyset$ . Then there exists a separating hyperplane.*

*Proof.* Set  $S = X - Y$ . Since  $0 \notin X$ , there exists a hyperplane which separates  $S$  and  $0$ . That is, there is a  $p \in \mathbb{R}^n$ ,  $p \neq 0$ , such that  $\langle p, s \rangle \geq \langle p, 0 \rangle$  for all  $s \in S$ , or equivalently

$$\langle p, x \rangle \geq \langle p, y \rangle$$

for all  $x \in X$  and for all  $y \in Y$ . Thus

$$\inf_{x \in X} \langle p, x \rangle \geq \sup_{y \in Y} \langle p, y \rangle,$$

which implies that there exists an  $\alpha$  such that

$$\langle p, x \rangle \geq \alpha \geq \langle p, y \rangle$$

for all  $x \in X$  and for all  $y \in Y$ .  $\square$

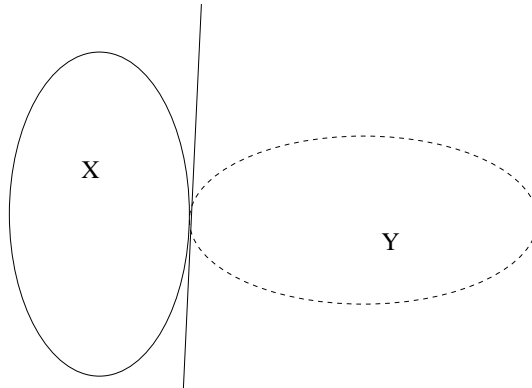

Figure 2.7: Separation of convex sets

### 2.6.2 Linear inequalities

Important consequences from the previous separation results are theorems about systems of linear inequalities.

**Lemma.** Let  $x^l \in \mathbb{R}^n$ ,  $l = 1, \dots, k$  are given, and set

$$C := \{x \in \mathbb{R}^n : x = \sum_{l=1}^k \lambda_l x^l, \lambda_l \geq 0\},$$

then the cone  $C$  is closed.

*Proof.* The proof is by induction with respect to  $k$ .

(i) Let  $k = 1$ . Suppose that  $y_j := \lambda_1^{(j)} x^1 \rightarrow y$  if  $j \rightarrow \infty$ , then

$$\lim_{j \rightarrow \infty} \lambda_1^{(j)} = \frac{\langle y, x^1 \rangle}{\langle x^1, x^1 \rangle},$$

provided that  $x^1 \neq 0$ .

(ii) Suppose the lemma is shown for all  $k$  satisfying  $1 \leq k \leq s-1$ . Then we will show the lemma if  $k = s$ . In the case that the cone  $C$  contains all of the vectors  $-x^1, \dots, -x^s$ , then  $C$  is a subspace of  $\mathbb{R}^n$ . Then the lemma is shown since a subspace is closed. Assume at least one of the vectors  $-x^1, \dots, -x^s$  is not in  $C$ , say  $-x^s$ . Then the cone

$$C' := \{x \in \mathbb{R}^n : x = \sum_{l=1}^{s-1} \lambda_l x^l, \lambda_l \geq 0\}$$

is closed by assumption. Consider a sequence  $y^j \rightarrow y$  as  $j \rightarrow \infty$ . Then

$$y^j = x^{j'} + \lambda^{(j)} x^s, \quad x^{j'} \in C', \quad \lambda^{(j)} \geq 0. \quad (2.12)$$

Suppose first that the sequence  $\lambda^{(j)}$  is unbounded. Let  $\lambda^{(j')} \rightarrow \infty$  for a subsequence  $\lambda^{(j')}$ , then it follows from the above decomposition (2.12) that

$$\lim_{j' \rightarrow \infty} \frac{x^{j'}}{\lambda^{j'}} = -x^s.$$

That is,  $-x^s \in C'$  since  $C'$  is closed. This is a contradiction to  $-x^s \notin C'$ .

If the sequence  $\lambda^{(j)}$  is bounded, then also the sequence  $x^{j'}$ , see the decomposition (2.12). Then it follows from (2.12) that  $y = x' + \lambda_0 x^s$ , where  $x' \in C'$  and  $\lambda_0 \geq 0$ .  $\square$

**Theorem 2.6.5.** *Let  $A = A(m, n)$  be a real matrix with  $m$  rows and  $n$  columns and let  $b \in \mathbb{R}^n$ . Then there exists a solution of  $Ay \geq 0$  and  $\langle b, y \rangle < 0$  if and only if there is no solution  $x \in \mathbb{R}^m$  of  $A^T x = b$  and  $x \geq 0$ .*

Proof. (i) Suppose that there is no solution of  $A^T x = b$  and  $x \geq 0$ . Set

$$S = \{s \in \mathbb{R}^n : s = A^T x, x \geq 0\}$$

and  $T = \{b\}$ . The above Lemma implies that the convex cone  $S$  is closed. Since  $S$  and  $T$  are disjoint, there exists a hyperplane which separates these sets strictly. Thus there are  $p \in \mathbb{R}^n$ ,  $p \neq 0$ , and  $\alpha \in \mathbb{R}$  such that

$$\langle p, b \rangle < \alpha < \langle p, s \rangle$$

for all  $s \in S$ . Thus  $\langle p, A^T x \rangle > \alpha$  for all  $x \geq 0$ . Set  $x = 0$ , then we see that  $\alpha < 0$ . Let  $x = x_j e^j$ , where  $x_j \in \mathbb{R}$  and  $x_j > 0$ , and  $e^j$  denotes the standard basis vectors in  $\mathbb{R}^m$ . Then

$$\langle p, A^T e^j \rangle > \frac{\alpha}{x_j}$$

for all positive  $x_j$ . It follows that  $\langle p, A^T e^j \rangle \geq 0$  for every  $j = 1, \dots, m$ . Thus  $p$  is a solution of  $Ay \geq 0$  and  $\langle b, y \rangle < 0$ .

(ii) Suppose that there is a solution  $y^0$  of  $Ay \geq 0$  and  $\langle b, y \rangle < 0$ . Then there is no solution of  $A^T x = b$  and  $x \geq 0$ ,  $x \in \mathbb{R}^m$ . If not, then

$$\langle b, y^0 \rangle = \langle A^T x, y^0 \rangle = \langle x, Ay^0 \rangle \geq 0.$$

□

The next theorem is a consequence of the previous result.

**Theorem 2.6.6** (Minkowski-Farkas Lemma). *Let  $A = A(m, n)$  be a real matrix with  $m$  rows and  $n$  columns and let  $b \in \mathbb{R}^n$ . Then  $\langle b, y \rangle \geq 0$  for all  $y \in \mathbb{R}^n$  satisfying  $Ay \geq 0$  if and only if there exists an  $x \in \mathbb{R}^m$ ,  $x \geq 0$ , such that  $A^T x = b$ .*

Proof. (i) Suppose that  $\langle b, y \rangle \geq 0$  for all  $y \in \mathbb{R}^n$  satisfying  $Ay \geq 0$ . If there is no solution of  $A^T x = b$ ,  $x \in \mathbb{R}^m$ ,  $x \geq 0$ , then the above Theorem 2.6.5 says that there is a solution of  $Ay \geq 0$  and  $\langle b, y \rangle < 0$ , a contradiction to the assumption.

(ii) Assume there exists an  $x^0 \in \mathbb{R}^m$ ,  $x^0 \geq 0$ , such that  $A^T x^0 = b$ . If there is a  $y \in \mathbb{R}^n$  such that  $Ay \geq 0$  and  $\langle b, y \rangle < 0$ , then there is no solution of

$A^T x = b$  and  $x \geq 0$ , see Theorem 2.6.5, which is a contradiction to the assumption.  $\square$

Another consequence of Theorem 2.6.5 is

**Theorem 2.6.7** (Alternative Theorem). *Either there exists a nonnegative solution of  $A^T x \leq b$  or there is a nonnegative solution of  $Ay \geq 0$  and  $\langle b, y \rangle < 0$ .*

*Proof.* (i) Suppose that there is a nonnegative solution  $x^0$  of  $A^T x \leq b$ . Set  $z = b - A^T x^0$ , then there exists a nonnegative solution of  $A^T x + z = b$ . Assume there is a nonnegative solution  $y^0$  of  $Ay \geq 0$  and  $\langle b, y \rangle < 0$ , then

$$0 > \langle b, y^0 \rangle = \langle A^T x^0 + z, y^0 \rangle = \langle x^0, Ay^0 \rangle + \langle z, y^0 \rangle \geq 0$$

since  $x^0 \geq 0, z \geq 0, y^0 \geq 0$  and  $Ay^0 \geq 0$ .

(ii) Suppose that there is no nonnegative solution of  $A^T x \leq b$ . Then there are no nonnegative  $x \in \mathbb{R}^m, z \in \mathbb{R}^n$  such that  $A^T x + z = b$ . Set  $w = (x, z)$  and  $B^T = A^T E_n$ , where

$$A^T E_n = \begin{pmatrix} a_{11} & \cdots & a_{m1} & 1 & \cdots & 0 \\ \dots\dots\dots\dots\dots\dots\dots\dots\dots\dots \\ a_{1n} & \cdots & a_{mn} & 0 & \cdots & 1 \end{pmatrix}.$$

Since there is no nonnegative solution of  $B^T w = b$ , we have a solution  $y^0$  of  $By \geq 0$  and  $\langle b, y \rangle < 0$ , see Theorem 2.2.13. Thus  $Ay \geq 0$  and  $y \geq 0$  since these inequalities are equivalent to  $By \geq 0$ .  $\square$

### 2.6.3 Projection on convex sets

Let  $p_V(z)$  be the projection of  $z \in H$ , where  $H$  is a real Hilbert space, onto a nonempty subset  $V \subseteq H$  defined by

$$\|p_V(z) - z\| = \min_{y \in V} \|y - z\|.$$

This projection exists if  $H = \mathbb{R}^n$  and if  $V$  is closed or in the case of a general real Hilbert space if  $V$  is closed and convex.

Thus we have  $w = p_V(z)$  if and only if  $w \in V$  solves

$$w \in V : \|w - z\|^2 \leq \|y - z\|^2 \text{ for all } y \in V.$$



Set  $y = w + \epsilon(y - x)$ ,  $0 \leq \epsilon \leq 1$ , then we observe that this inequality is equivalent to

$$\langle p_V(z) - z, y - p_V(z) \rangle \geq 0 \quad \text{for all } y \in V, \quad (2.13)$$

see an exercise.

**Corollary.** *The projection  $p_V$  of a real Hilbert space  $H$  onto a closed nonempty convex subset  $V$  is nonexpansive, i. e.,*

$$\|p_V(x) - p_V(y)\| \leq \|x - y\|.$$

*Proof.* Exercise.

In the case that  $V$  is a closed convex cone  $K$  with vertex at the origin, then there is an interesting decomposition result due to Moreau [45].

**Definition.** The cone

$$K^* = \{v \in H : \langle v, u \rangle \leq 0 \quad \text{for all } u \in K\}$$

is called *polar cone* to  $K$ .

**Moreau's decomposition lemma.** *For given  $u \in H$  there are uniquely determined  $u_1 \in K$ ,  $u_2 \in K^*$  satisfying  $\langle u_1, u_2 \rangle = 0$ , such that*

$$u = u_1 + u_2.$$

*Moreover,  $u_1 = p_K(u)$  and  $u_2 = p_{K^*}(u)$ .*

*Proof.* (i) Existence of the decomposition. Set  $u_1 = p_K u$ ,  $u_2 = u - u_1$ . Then, see (2.13),  $\langle u - u_1, v - u_1 \rangle \leq 0$  for all  $v \in K$ . Thus

$$\langle u_2, v - u_1 \rangle \leq 0 \quad \text{for all } v \in K. \quad (2.14)$$

Replacing in (2.14)  $v$  by the admissible element

$$v + u_1 \equiv 2 \left( \frac{1}{2}v + \frac{1}{2}u_1 \right),$$

then

$$\langle u_2, v \rangle \leq 0 \quad \text{for all } v \in K. \quad (2.15)$$

Thus  $u_2 \in K^*$ . Replacing  $v$  in (2.14) by  $tu_1$ ,  $t > 0$ , we get

$$(1-t)\langle u_1, u_2 \rangle \leq 0,$$

which implies that  $\langle u_1, u_2 \rangle = 0$ .

(ii) Uniqueness and  $u_1 = p_K(u)$ ,  $u_2 = p_{K^*}(u)$ . Suppose that  $u = u_1 + u_2$ , where  $u_1 \in K$ ,  $u_2 \in K^*$  and  $\langle u_1, u_2 \rangle = 0$ . Let  $v \in K$ , then

$$\langle u - u_1, v - u_1 \rangle = \langle u_2, v - u_1 \rangle = \langle u_2, v \rangle \leq 0,$$

which implies that  $u_1 = p_K(u)$ , see (2.13). By the same reasoning we conclude that  $u_2 = p_{K^*}(u)$  since for  $v' \in K^*$  we have

$$\langle u - u_2, v' - u_2 \rangle = \langle u_1, v' - u_2 \rangle = \langle u_1, v' \rangle \leq 0.$$

□

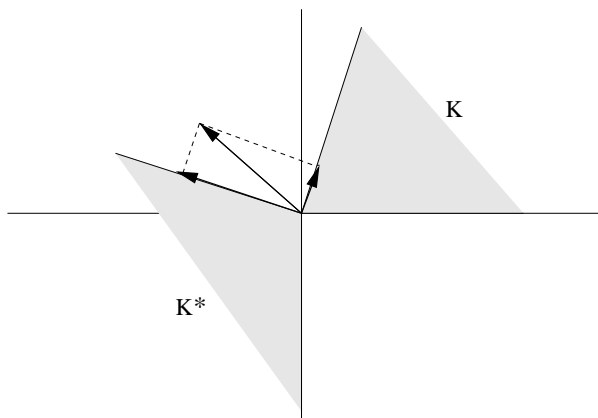

Figure 2.8: Moreau's decomposition lemma

#### 2.6.4 Lagrange multiplier rules

There is a large variety of Lagrange multiplier rules for equations and inequalities, see for example [60]. We will present two Lagrange multiplier rules. The following lemmas can easily be extended to more than one side conditions.

Let  $H$  be a real Hilbert space with the inner product  $\langle u, v \rangle$ ,  $u, v \in H$ . Suppose that  $f(h) = 0$  for all  $h \in V \cap Z$ , where  $f$  is a bounded linear functional on  $H$ ,  $V \subset H$  a nonempty subspace,  $Z = \{h \in H : g(h) = 0\}$ , and  $g$  is another bounded linear functional defined on  $H$ . Then we have

**Lagrange multiplier rule** (equation). *There exists a real  $\lambda_0$  such that*

$$f(w) + \lambda_0 g(w) = 0$$

for all  $w \in V$ .

*Proof.* There are  $F, G \in \text{cl } V$ , where  $\text{cl } V$  denotes the closure of  $V$  with respect to the Hilbert space norm, such that

$$f(h) = \langle F, h \rangle, \quad g(h) = \langle G, h \rangle$$

for all  $h \in \text{cl } V$ . Set  $Y = \text{span } G$ , then  $\text{cl } V = Y \oplus Y^\perp$ . Then  $F = F_1 + F_2$ , where  $F_1 \in Y$  and  $F_2 \in Y^\perp$ . Since  $\langle F, F_2 \rangle = 0$ , we get  $F_2 = 0$ . Consequently  $F + \lambda_0 G = 0$ , or

$$\langle F, h \rangle + \lambda_0 \langle G, h \rangle = 0$$

for all  $h \in \text{cl } V$ . □

Assume  $f(h) \geq 0$  for all  $h \in K \cap Z$ , where  $K \subset V$  is a nonempty convex cone with vertex at zero,  $Z = \{h \in H : g(h) = 0\}$  and  $f, g$  are bounded linear functionals defined on  $H$ . We recall that  $K$  is said to be a cone with vertex at zero if  $h \in K$  implies that  $t h \in K$  for all  $t > 0$ . By  $C^*$  we denote the polar cone of a cone with vertex at the origin. The polar cone of a cone  $C \subset \text{cl } V$  with the vertex at zero is defined to be the cone  $C^* = \{v \in \text{cl } V : \langle v, w \rangle \leq 0 \text{ for all } w \in C\}$ .

**Lagrange multiplier rule** (variational inequality). *Suppose that there is an  $h_0 \in K$  such that  $-h_0 \in K$  and  $g(h_0) \neq 0$ . Then there exists a real  $\lambda_0$  such that*

$$f(w) + \lambda_0 g(w) \geq 0$$

for all  $w \in K$ .

*Proof.* Following the proof of the previous lemma, we find that  $\langle F, h \rangle \geq 0$  for all  $h \in \text{cl } K \cap \text{cl } Z$ . Thus  $-F \in (\text{cl } K \cap \text{cl } Z)^*$ . Then the proof is based on the formula, see the lemma below,

$$(\text{cl } K \cap \text{cl } Z)^* = \text{cl } (K^* + Z^*).$$

Thus, since  $Z^* = \text{span } \{G\}$ , it follows

$$-F \in \text{cl } (K^* + \text{span } \{G\}).$$

Then there are sequences  $z_n \in K^*$ ,  $y_n \in \text{span } \{G\}$  such that  $z_n + y_n \rightarrow -F$  in  $\text{cl } V$ . If the sequence  $y_n$  remains bounded, then there is a convergent subsequence  $y_{n'} \rightarrow y$ . Consequently  $z_{n'} \rightarrow z \in K^*$  which implies that  $-F \in K^* + y$ . Thus there is a real  $\lambda_0$  satisfying  $-F - \lambda_0 G \in K^*$ , or equivalently,  $\langle F + \lambda_0 G, h \rangle \geq 0$  for all  $h \in \text{cl } K$ .

Suppose that the sequence  $y_n \in \text{span } \{G\}$  is unbounded. Set  $w_n = z_n + y_n$ , then  $w_n - y_n = z_n \in K^*$ . Thus  $\langle w_n - y_n, h \rangle \leq 0$  for all  $h \in \text{cl } K$ , or

$$\langle w_n, h \rangle - \lambda_n \langle G, h \rangle \leq 0$$

for all  $h \in \text{cl } K$ . Since  $|\lambda_n| \rightarrow \infty$ , we get  $\langle G, h \rangle \leq 0$  for all  $h \in \text{cl } K$  or  $\langle G, h \rangle \geq 0$  for all  $h \in \text{cl } K$ , which is a contradiction to the assumption of the lemma.  $\square$

Extending [49], Corollary 11.25(b), p. 495, or [50], Corollary 16.4.2, p. 146, to a real Hilbert space we get the following lemma.

**Lemma.** *Let  $H$  be a real Hilbert space. Suppose that  $K_1, \dots, K_m \subset H$  are nonempty, closed and convex cones with vertex at the origin. Then*

$$(K_1 \cap \dots \cap K_m)^* = \text{cl } (K_1^* \dots + K_m^*)$$

*Proof.* (i) The inclusion

$$(K_1^* \dots + K_m^*) \subset (K_1 \cap \dots \cap K_m)^*$$

follows since we have for given  $v_i \in K_i^*$  that  $\langle v_i, h \rangle \leq 0$  for all  $h \in K_i$ . Consequently  $\langle v_1 + \dots + v_m, h \rangle \leq 0$  for all  $h \in K_1 \cap \dots \cap K_m$ . Thus  $v_1 + \dots + v_m \in (K_1 \cap \dots \cap K_m)^*$ .

(ii) Set  $C = \text{cl } (K_1^* \dots + K_m^*)$ . Let  $w \in (K_1 \cap \dots \cap K_m)^*$  be given and suppose that  $w \notin C$ . From a separation theorem, see one of the following exercises, it follows that there is a  $p \in H$  such that  $\langle p, w \rangle > 0$  and  $\langle p, y \rangle \leq 0$  for all  $y \in C$ . We have  $\langle w, v \rangle \leq 0$  for all  $v \in K_1 \cap \dots \cap K_m$  and  $\langle p, y \rangle \leq 0$  for all  $y \in K_1^* \dots + K_m^*$ . The previous inequality shows that  $p \in K_i$  for all  $i$ . Then  $\langle w, p \rangle \leq 0$  in contrast to a separation theorem.  $\square$

## 2.6.5 Exercises

1. Prove the related Theorem 2.6.1 where  $X$  is a closed and convex subset of a real Hilbert space.
2. Show that the closure of  $X$  is convex if  $X$  is convex.
3. Let  $x^l \in \mathbb{R}^n$ ,  $l = 1, \dots, k$ , are given linearly independent vectors, and set

$$C := \{x \in \mathbb{R}^n : x = \sum_{l=1}^k \lambda_l x^l, \lambda_l \geq 0\}.$$

Show that  $C$  is closed by using the following hints.

*Hint:* Let  $y^j \in C$ , i. e.,  $y^j = \sum_{l=1}^k \lambda_l^{(j)} x^l$ ,  $\lambda_l \geq 0$ , where  $\lambda_l^{(j)} \geq 0$ , and  $y^j \rightarrow y$  as  $j \rightarrow \infty$ . Then consider two cases

- (a) all sequences  $\lambda_l^{(j)}$  are bounded,
- (b) not all of these sequences are bounded. Then set

$$a_j = \max\{\lambda_1^{(j)}, \dots, \lambda_k^{(j)}\}$$

and divide  $y^j$  by  $a_j$ .

4. Suppose that  $V \subset H$  is a nonempty, convex and closed subset of a real Hilbert space. Show that

$$w \in V : \|w - z\|^2 \leq \|y - z\|^2 \text{ for all } y \in V$$

is equivalent to

$$w \in V : \langle w - z, y - w \rangle \geq 0 \text{ for all } y \in V.$$

5. Suppose that  $V \subset H$  is nonempty, convex and closed. Show that for given  $z \in H$  there exists a solution of

$$\min_{v \in V} \|v - z\|^2,$$

and this solution is uniquely determined.

*Hint:* Theorem of Banach-Saks: let  $V \subset H$  be closed and convex, then  $V$  is weakly closed.

6. Show that the projection of a real Hilbert space on a nonempty closed convex set is a nonexpansive mapping.

*Hint:* Use formula (2.13).

7. Show that the polar cone  $K^*$  is a convex and closed cone with vertex at the origin.
8. Let  $K$  be a closed convex cone with the vertex at the origin. Show that  $(K^*)^* = K$ .
9. *Separation theorem.* Let  $H$  be a real Hilbert space and  $V$  a nonempty, closed and convex subset. Let  $w \in H$  and  $w \notin V$ . Show that there is a real  $\lambda$  such that  $\langle p, y \rangle \leq \lambda < \langle p, w \rangle$  for all  $y \in V$ .  
*Hint:* Consider the minimum problem  $\min_{y \in V} \|y - w\|^2$  and use the Banach-Saks theorem that a closed convex subset is weakly closed.
10. *Separation theorem.* Let  $V$  in the previous exercise be a closed convex cone  $C$  with vertex at zero. Then  $\langle p, y \rangle \leq 0 < \langle p, w \rangle$  for all  $y \in C$ .
11. *Generalization of the Lagrange multiplier rule for equations.* Suppose that  $f(h) = 0$  for all  $h \in V \cap Z$ , where  $Z = \{h \in H : g_j(h) = 0, j = 1, \dots, N\}$  and  $g_j$  are bounded linear functionals on  $H$ . Then there exists real  $\lambda_j$  such that

$$f(w) + \sum_{j=1}^N \lambda_j g_j(w) = 0$$

for all  $w \in V$ .

12. *Generalization of the Lagrange rule for variational inequalities.* Let  $K \subset V$  be a convex cone with vertex at the origin. Suppose that  $f(h) \geq 0$  for all  $h \in K \cap Z$ , where  $Z = \{h \in H : g_j(h) = 0, j = 1, \dots, N\}$  and  $g_j$  are bounded linear functionals on  $H$ . Assume there are  $h_l \in K, l = 1, \dots, N$  such that  $-h_l \in K$  and  $g_j(h_l) = \delta_{jl}$ . Then there exists real  $\lambda_j$  such that

$$f(w) + \sum_{j=1}^N \lambda_j g_j(w) \geq 0$$

for all  $w \in K$ .

*Hint:* There are  $G_j \in H$  such that  $Z = \{h \in H : \langle G_j, h \rangle = 0, j = 1, \dots, N\}$ . Set  $M = \{G \in H : G = \sum_{j=1}^N \lambda_j G_j, \lambda_j \in \mathbb{R}\}$  and show that  $Z = M^*$ .

## 2.7 References

The main part of this material is quite standard. The first order necessary condition and the concept of a local tangent cone was adopted from Lions [34].

The presentation of the main results and proofs concerning Lagrange multiplier rules was adopted from Hestenes [23], see also Luenberger [36].

Concerning applications, the study of eigenvalue equations is quite standard, see for example Courant and Hilbert [9]. The case of unilateral eigenvalue problems is a finite dimensional version of problems due to Mierse-  
mann [37]. The first part concerning noncooperative games is adopted from Luenberger [36]. The equilibrium concept for noncooperative games is due to Cournot [10]. A first existence proof was given by Nash [46]. The concept of a local equilibrium is a straightforward generalization. References for noncooperative games with applications to economy are Debreu [11], Friedman [18] and Luenberger [36], for example. For other applications of finite dimensional variational calculus to economics see [58].

A source for variational calculus in  $\mathbb{R}^n$  is Rockafellar and Wets [49] and Rockafellar [50] for convex sets.





## Chapter 3

# Ordinary differential equations

The most part of this chapter concerns classical results of the calculus of variations.

### 3.1 Optima, tangent cones, derivatives

Let  $B$  be a real Banach space and  $H$  a real Hilbert space such that  $B \subseteq H$  is continuously embedded, that is,  $\|v\|_H \leq c\|v\|_B$  for all  $v \in B$ . Moreover, we assume that  $\|v\|_B \neq 0$  implies  $\|v\|_H \neq 0$  for  $v \in B$ .<sup>1</sup>

In most applications of this chapter we have  $B = C^1[a, b]$  and  $H = H^1(a, b)$ , which is the Sobolev space of all functions  $v$  which have generalized derivatives of first order which are, together with the functions itself in  $L^2(a, b)$ .

Let  $V \subseteq B$  be a nonempty subset and suppose that  $E : V \mapsto \mathbb{R}$ .

**Definition.** A  $u \in V$  is said to be a *weak local minimizer* of  $E$  in  $V$  if there is a  $\rho > 0$  such that

$$E(u) \leq E(v) \quad \text{for all } v \in V, \|v - u\|_B < \rho.$$

A weak local minimizer is said to be a *strict weak local minimizer* if  $E(u) < E(v)$  for all  $v \in V$ ,  $v \neq u$ ,  $\|v - u\|_B < \rho$ .

---

<sup>1</sup>More precisely, we assume that there is an injective embedding  $j : B \mapsto H$ , i. e.,  $j$  is linear and bounded and  $\|v\|_B \neq 0$  implies  $\|j(v)\|_H \neq 0$ .

**Remark.** A local minimizer is said to be a strong local minimizer with respect to a given norm which allows a larger class of comparison elements as above. In the classical calculus of variations this norm is the  $C[a, b]$ -norm.

**Definition.** The *local tangent cone*  $T(V, u)$  of  $V$  at  $u \in V$  is the set of all  $w \in H$  such that there exists sequences  $u_n \in V$ ,  $t_n \in \mathbb{R}$ ,  $t_n > 0$ , such that  $u_n \rightarrow u$  in  $B$  and  $t_n(u_n - u) \rightarrow w$  in  $H$ .

**Corollaries.** (i) *The set  $T(V, u)$  is a cone with vertex at zero.*

(ii) *If  $T(V, u) \neq \{0\}$  then  $u$  is not isolated.*

(iii) *Suppose that  $w \neq 0$ , then  $t_n \rightarrow \infty$ .*

(iv)  *$T(V, u)$  is weakly closed in  $H$ .*

(v)  *$T(V, u)$  is convex if  $V$  is convex.*

(vi) *Assume  $V$  is convex. Then*

$$T(V, u) = \{w \in H : \text{there exists sequences } u_n \in V, t_n \in \mathbb{R}, t_n > 0, \\ \text{such that } t_n(u_n - u) \rightarrow w \text{ as } n \rightarrow \infty\}.$$

*Proof.* Exercise.

**Definition** (Fréchet derivative). The functional  $E$  is said to be *Fréchet differentiable* at  $u \in B$  if there exists a bounded linear functional  $l$  on  $B$  such that

$$E(u + h) = E(u) + l(h) + o(\|h\|_B),$$

as  $\|h\|_B \rightarrow 0$ .

Notation:  $l = DE(u)$  Fréchet derivative of  $E$  at  $u$ .

**Definition** (Gâteaux derivative). For  $t \in \mathbb{R}$  and fixed  $h \in B$  set  $\Phi(t) = E(u + th)$ . The functional  $E$  is said to be *Gâteaux differentiable* at  $u \in B$  if there is a bounded linear functional  $l$  on  $B$  such that  $\Phi'(0)$  exists and  $\Phi'(0) = l(h)$ .

Notation:  $l = E'(u)$  Gâteaux derivative of  $E$  at  $u$ .

**Corollaries.**

(i) If  $f$  is Fréchet differentiable at  $u$  then  $f$  is Gâteaux differentiable at  $u$ .

(ii) If  $E'$  exists and is continuous in a neighbourhood of  $u$ , then  $E'(u) = DE(u)$ .

*Proof.* Exercise.

**Definition** (First and second variation). The derivative

$$\delta E(u)(h) := \left[ \frac{d}{d\epsilon} E(u + \epsilon h) \right]_{\epsilon=0},$$

if it exists, is said to be the *first variation* (or first Gâteaux variation) of  $E$  at  $u$  in direction  $h$ .

The derivative

$$\delta^2 E(u)(h) := \left[ \frac{d^2}{d\epsilon^2} E(u + \epsilon h) \right]_{\epsilon=0},$$

if it exists, is said to be the *second variation* (or second Gâteaux variation) of  $E$  at  $u$  in direction  $h$ .

The limits, if they exist,

$$\delta^+ E(u)(h) = \lim_{t \rightarrow 0, t > 0} \frac{E(u + th) - E(u)}{t}$$

and

$$\delta^- E(u)(h) = \lim_{t \rightarrow 0, t < 0} \frac{E(u + th) - E(u)}{t}$$

are called *right variation* and *left variation*, respectively.

**Corollary.** Suppose the Gâteaux derivative exists then also the Gâteaux variation and  $\delta E(u)(h) = \langle E'(u), h \rangle$ .

## 3.1.1 Exercises

1. Suppose that  $V \subset H$  is not empty, where  $H$  is a Hilbert space. Show that  $T(V, x)$  is weakly closed in  $H$ .
2. Show that  $E'(x) = Df(u)$  if  $E'(v)$  exists and is continuous in a neighbourhood of  $u$ .
3. Show that, in general, the existence of the Gâteaux derivative does not imply the existence of the Fréchet derivative.

*Hint:* Consider  $X = \mathbb{R}^2$  and the derivatives of  $f$  at  $(0, 0)$ , where

$$f(y) = \begin{cases} \left( \frac{y_1 y_2^2}{y_1^2 + y_2^2} \right)^2 & : (y_1, y_2) \neq (0, 0) \\ 0 & : (y_1, y_2) = (0, 0) \end{cases}$$

4. Suppose that the Gâteaux derivative exists. Show that the Gâteaux variation exists and  $(\delta E)(h) = \langle E'(u), h \rangle$ .
5. Set for  $y \in \mathbb{R}^2$

$$f(y) = \begin{cases} \frac{y_1 y_2^2}{y_1^2 + y_2^2} & : y \neq (0, 0) \\ 0 & : y = (0, 0) \end{cases}$$

Show that there exists the first variation at  $(0, 0)$ , and that the Gâteaux derivative at  $(0, 0)$  does not exist.

6. (i) Show that  $\delta E(u)(h)$  is homogeneous of degree one, i. e.,

$$\delta E(u)(\lambda h) = \lambda \delta E(u)(h)$$

for all  $\lambda \in \mathbb{R}$ .

(ii) Show that the right variation is positive homogeneous of degree one.

7. Show that  $\delta^2 E(u)(h)$  is homogeneous of degree two.
8. Set  $\Phi(t) = E(u + th)$  and suppose that  $\Phi \in C^2$  in a neighbourhood of  $t = 0$ . Show that

$$E(u + th) = E(u) + t\delta E(u)(h) + \frac{t^2}{2}\delta^2 E(u)(h) + \epsilon_2(th),$$

where  $\lim_{t \rightarrow 0} \epsilon_2(th)/t^2 = 0$  for fixed  $h$ .

### 3.2 Necessary conditions

Let  $u, h \in B$ , and assume that the expansion

$$E(u+h) = E(u) + \langle E'(u), h \rangle + \eta(\|h\|_B) \|h\|_H \quad (3.1)$$

holds, as  $\|h\|_B \rightarrow 0$ , where  $\lim_{t \rightarrow 0} \eta(t) = 0$  and  $\langle E'(u), h \rangle$  is a bounded linear functional on  $B$  which admits an extension to a bounded linear functional on  $H$ .

This assumption implies that  $E$  is Fréchet differentiable at  $u$ .

**Example.**  $E(v) = \int_0^1 v'(x)^2 dx$ ,  $\langle E'(u), h \rangle = 2 \int_0^1 u'(x)v'(x) dx$ ,  $B = C^1[0, 1]$ ,  $H = H^1(0, 1)$ .

**Theorem 3.2.1** (Necessary condition). *Let  $V \subset B$  be a nonempty subset and suppose that  $u \in V$  is a weak local minimizer of  $E$  in  $V$ , then*

$$\langle E'(u), w \rangle \geq 0 \quad \text{for all } w \in T(V, u).$$

*Proof.* Let  $t_n, u_n$  be associated sequences to  $w \in T(V, u)$ . Then, if  $n$  is sufficiently large,

$$\begin{aligned} E(u) &\leq E(u_n) = E(u + (u_n - u)) \\ &= E(u) + \langle E'(u), u_n - u \rangle + \eta(\|u_n - u\|_B) \|u_n - u\|_H, \end{aligned}$$

thus

$$\begin{aligned} 0 &\leq \langle E'(u), u_n - u \rangle + \eta(\|u_n - u\|_B) \|u_n - u\|_H, \\ 0 &\leq \langle E'(u), t_n(u_n - u) \rangle + \eta(\|u_n - u\|_B) \|t_n(u_n - u)\|_H. \end{aligned}$$

Letting  $n \rightarrow \infty$ , the theorem is shown.  $\square$

#### 3.2.1 Free problems

Set

$$E(v) = \int_a^b f(x, v(x), v'(x)) dx$$

and for given  $u_a, u_b \in \mathbb{R}$

$$V = \{v \in C^1[a, b] : v(a) = u_a, v(b) = u_b\},$$

where  $-\infty < a < b < \infty$  and  $f$  is sufficiently regular. See Figure 3.1 for admissible variations. One of the basic problems in the calculus of variation

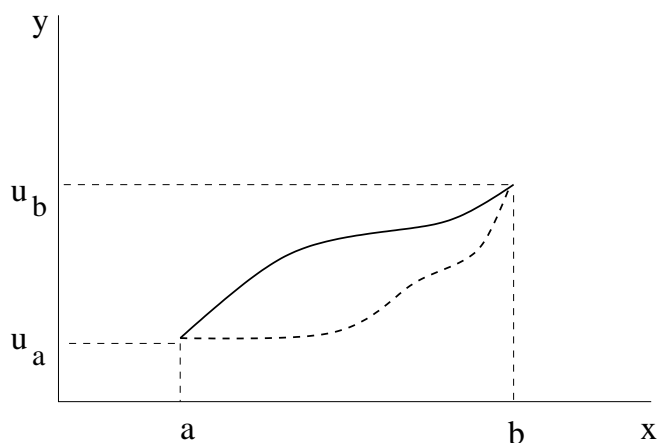

Figure 3.1: Admissible variations

is

$$(P) \quad \min_{v \in V} E(v).$$

It follows from the necessary condition (Theorem 3.2.1) that

$$\int_a^b [f_u(x, u(x), u'(x))\phi(x) + f_{u'}(x, u(x), u'(x))\phi'(x)] dx = 0 \quad (3.2)$$

for all  $\phi \in V - V$ , since the left hand side of (3.2) is equal to  $\langle E'(u), \phi \rangle$  and since  $V - V \subset T(V, u)$ . The previous inclusion follows from Corollary (v) of Section 3.1, or directly since for given  $v \in V$  we have  $n(u_n - u) = v - u$ , where  $u_n := u + (v - u)/n$ ,  $n$  an integer.

In our case of admissible comparison functions we can derive this equation under weaker assumptions.

**Definition.** A  $u \in V$  is said to be a *weak* local minimizer of  $E$  in  $V$  if there exists an  $\epsilon_0 > 0$  such that

$$E(u) \leq E(v) \quad \text{for all } v \in V : \|v - u\|_{C^1[a, b]} < \epsilon.$$

A  $u \in V$  is called *strong local minimizer* of  $E$  in  $V$  if there exists an  $\epsilon_0 > 0$  such that

$$E(u) \leq E(v) \quad \text{for all } v \in V : \|v - u\|_{C[a,b]} < \epsilon.$$

We say that  $u \in V$  is a *local minimizer* if  $u$  is a weak or a strong local minimizer.

**Corollary.** *A strong local minimizer is a weak local minimizer.*

**Theorem 3.2.3.** *Let  $u \in V$  be a local minimizer of (P). Assume the first variation of  $E$  at  $u$  in direction  $\phi \in V - V$  exists, then equation (3.2) holds.*

*Proof.* Set  $g(\epsilon) = E(u + \epsilon\phi)$  for fixed  $\phi \in \Phi$  and  $|\epsilon| < \epsilon_0$ . Since  $g(0) \leq g(\epsilon)$  it follows  $g'(0) = 0$  which is equation (3.2).  $\square$

**Definition.** A solution  $u \in V$  of equation (3.2) is said to be a *weak extremal*.

From the basic lemma in the calculus of variations, see Chapter 1, it follows that a weak extremal satisfies the Euler equation

$$\frac{d}{dx} f_{u'}(x, u(x), u'(x)) = f_u(x, u(x), u'(x))$$

in  $(a, b)$ , provided that  $u \in C^2(a, b)$ . We will see that the assumption  $u \in C^2$  is superfluous if  $f_{u'u'} \neq 0$  on  $(a, b)$ .

**Lemma** (Du Bois-Reymond). *Let  $h \in C[a, b]$  and*

$$\int_a^b h(x)\phi'(x)dx = 0$$

*for all  $\phi \in \Phi$ , then  $h = \text{const.}$  on  $[a, b]$ .*

*Proof.* Set

$$\phi_0(x) = \int_a^x h(\zeta) d\zeta - \frac{x-a}{b-a} \int_a^b h(\zeta) d\zeta.$$

Then

$$\phi_0'(x) = h(x) - \frac{1}{b-a} \int_a^b h(\zeta) d\zeta.$$

Since  $\phi_0 \in \Phi$ , in particular  $\phi_0(a) = \phi_0(b) = 0$ , it follows

$$\begin{aligned} 0 = \int_a^b h\phi'_0 dx &= \int_a^b \phi'_0(x)^2 dx + \frac{1}{b-a} \int_a^b h(\zeta) d\zeta \int_a^b \phi'_0(x) dx \\ &= \int_a^b \phi'_0(x)^2 dx. \end{aligned}$$

Thus

$$h(x) = \frac{1}{b-a} \int_a^b h(\zeta) d\zeta.$$

□

**Theorem 3.2.5** (Regularity). *Suppose that  $f \in C^2$  and that  $u \in C^1[a, b]$  is a weak extremal. Assume*

$$f_{u'u'}(x, u(x), u'(x)) \neq 0$$

on  $[a, b]$ . Then  $u \in C^2[a, b]$ .

*Proof.* Set

$$P(x) = \int_a^x f_u(\zeta, u(\zeta), u'(\zeta)) d\zeta.$$

Then (3.2) is equivalent to

$$\int_a^b (-P + f_{u'})\phi' dx = 0$$

for all  $\phi \in \Phi$ . The above lemma implies that  $f_{u'} - P = \text{const} = c$  on  $[a, b]$ . Set

$$F(x, p) = f_{u'}(x, u(x), p) - \int_a^x f_u(\zeta, u(\zeta), u'(\zeta)) d\zeta - c.$$

Let  $x_0 \in [a, b]$  and  $p_0 = u'(x_0)$ . Since  $F(x_0, p_0) = 0$  and  $F_p(x_0, p_0) = f_{u'u'}(x_0, u(x_0), u'(x_0))$ , it follows from the implicit function theorem that there is a unique  $p = p(x)$ ,  $p \in C^1$  in a neighbourhood of  $x_0$ , such that  $p(x_0) = p_0$  and  $F(x, p(x)) \equiv 0$  in a neighbourhood of  $x_0$ . The uniqueness implies that  $p(x) = u'(x)$  in a neighbourhood of  $x_0$ . □

**Corollary.** *Suppose  $f \in C^m$  in its arguments,  $m \geq 2$ , then  $u \in C^m[a, b]$ .*



*Proof.* Exercise.

Example: **How much should a nation save?**

This example was taken from [55], pp. 13. Let  $K = K(t)$  be the capital stock of the nation at time  $t$ ,  $C(t)$  consumption,  $Y = Y(t)$  net national product.

We assume that  $Y = f(K)$ , where  $f$  is sufficiently regular and satisfies  $f'(K) > 0$  and  $f''(K) \leq 0$ . Then the national product is a strictly increasing concave function of the capital stock. Further we assume that

$$C(t) = f(K(t)) - K'(t),$$

which means that "consumption=net production - investment".

$U(C)$  denotes the utility function of the nation. We suppose that  $U'(C) > 0$  and  $U''(C) < 0$ ,

$\rho$  denotes the discount factor.

Set

$$V = \{K \in C^1[0, T] : K(0) = K_0, K(T) = K_T\},$$

where  $T > 0$ ,  $K_0$  and  $K_T$  are given, and let

$$E(K) = \int_0^T U(f(K(t)) - K'(t)) e^{-\rho t} dt.$$

Then we consider the maximum problem

$$\max_{K \in V} E(K).$$

Set

$$F(t, K, K') = U(f(K) - K')e^{-\rho t},$$

then the associated Euler equation is

$$\frac{d}{dt} F_{K'} = F_K$$

on  $0 < t < T$ . We have

$$\begin{aligned} F_{K'} &= -U'(f(K) - K')e^{-\rho t} \\ F_K &= U'(f(K) - K')f'(K)e^{-\rho t} \\ F_{K'K'} &= U''(f(K) - K')e^{-\rho t}. \end{aligned}$$

It follows from the above assumption that a weak extremal  $K_0$  satisfies  $F_{K'} < 0$ ,  $F_{K'K'} > 0$  on  $[0, T]$ . Consequently a weak extremal is in  $C^2[0, T]$  if the involved functions are sufficiently regular.

The above assumptions imply that

$$\begin{aligned} \langle E''(K)\zeta, \zeta \rangle &\equiv \int_0^T (F_{KK}\zeta^2 + 2F_{KK'}\zeta\zeta' + F_{K'K'}\zeta'^2) dt \\ &\leq 0 \end{aligned}$$

for all  $K \in V$  and for all  $\zeta \in V - V$ . If additionally  $f'' < 0$ , then

$$\langle E''(K)\zeta, \zeta \rangle \leq -c(K, T) \int_0^T \zeta^2 dt$$

for all  $K \in V$  and for all  $\zeta \in V - V$ ,  $c(K, T)$  is a positive constant, see an exercise. This implies the following result.

*A weak extremal  $K_0 \in V$  is a global maximizer of  $E(K)$  in  $V$ . If additionally  $f'' < 0$ , then weak extremals are uniquely determined.*

*Proof.* Set  $h(t) = E(K_0 + t(K - K_0))$ . Then

$$h(t) - h(0) = h'(0)t + \int_0^t (t-s)h''(s) ds.$$

Thus

$$\begin{aligned} E(K) - E(K_0) &= \langle E'(K_0), K - K_0 \rangle \\ &+ \int_0^1 (1-s) \langle E''(K_0 + s(K - K_0))(K - K_0), K - K_0 \rangle ds. \end{aligned}$$

□

Consider again the general functional

$$E(v) = \int_a^b f(x, v(x), v'(x)) dx,$$

where  $v \in V = \{v \in C^1[a, b] : v(a) = u_a, v(b) = u_b\}$ . We will see in the next section that the following necessary condition of second order is close

to a sufficient condition for a weak local minimizer. Set

$$\begin{aligned} \langle E''(u)\phi, \phi \rangle &= \int_a^b (f_{u'u'}(x, u(x), u'(x))\phi'(x))^2 \\ &\quad + 2f_{uu'}(x, u(x), u'(x))\phi(x)\phi'(x) \\ &\quad + f_{uu}(x, u(x), u'(x))\phi(x)^2 dx. \end{aligned}$$

**Theorem 3.2.6** (Necessary condition of second order). *Let  $u \in V$  be a local minimizer, then*

$$\langle E''(u)\phi, \phi \rangle \geq 0$$

for all  $\phi \in V - V$ .

*Proof.* Set  $g(\epsilon) = E(u + \epsilon\phi)$  for  $|\epsilon| < \epsilon_0$  and fixed  $\phi \in \Phi$ , then

$$g(0) \leq g(\epsilon) = g(0) + g'(0)\epsilon + \frac{1}{2}g''(0)\epsilon^2 + o(\epsilon^2)$$

as  $\epsilon \rightarrow 0$ . Since  $g'(0) = 0$  it follows  $g''(0) \geq 0$ , which is the inequality of the theorem.  $\square$

From this necessary condition it follows a condition which is close to the assumption from which regularity of a weak extremal follows.

**Theorem 3.2.7** (Legendre condition). *Assume  $u \in V$  satisfies the necessary condition of the previous theorem. Then*

$$f_{u'u'}(x, u(x), u'(x)) \geq 0$$

on  $[a, b]$ .

*Proof.* (i) Since the inequality of Theorem 3.2.6 holds for  $\phi$  in the Sobolev space  $H_0^1(a, b)$  the following function  $\phi_h$  is admissible. Let  $\phi_h(x)$  be continuous on  $[a, b]$ , zero on  $|x - x_0| \geq h$ ,  $\phi_h(x_0) = h$  and linear on  $x_0 - h < x < x_0$  and  $x_0 < x < x_0 + h$ . Set  $\phi = \phi_h$  in the necessary condition, then

$$0 \leq \int_{x_0-h}^{x_0+h} f_{u'u'} dx + 2h \int_{x_0-h}^{x_0+h} |f_{uu'}| dx + h^2 \int_{x_0-h}^{x_0+h} |f_{uu}| dx,$$

which implies

$$0 \leq 2hf_{u'u'}(x_1, u(x_1), u'(x_1)) + 4h^2 \max_{[x_0-h, x_0+h]} |f_{uu'}| + 2h^3 \max_{[x_0-h, x_0+h]} |f_{uu}|,$$

where  $x_1 = x_1(h) \in [x_0 - h, x_0 + h]$ . Then divide by  $h$  and letting  $h$  to zero.

(ii) The inequality of the theorem follows also by inserting the admissible function

$$\phi_h(x) = \begin{cases} \frac{1}{h^3} (h^2 - |x - x_0|^2)^2 & \text{if } |x - x_0| \leq h \\ 0 & \text{if } |x - x_0| > h \end{cases}.$$

□

**Definition.** A weak extremal is said to be satisfying the *Legendre condition* if  $f_{u'u'}(x, u(x), u'(x)) \geq 0$  on  $[a, b]$  and it satisfies the *strict Legendre condition* if  $f_{u'u'} > 0$  on  $[a, b]$ .

From the regularity theorem (Theorem 3.2.5) it follows immediately

**Corollary.** If  $f \in C^2$  and an extremal  $u$  satisfies the strict Legendre condition, then  $u \in C^2[a, b]$ .

In the following we will derive a further necessary condition which follows from  $\langle E''(u)\phi, \phi \rangle \geq 0$  for all  $\phi \in \Phi$ . From the strict inequality for all  $\phi \in \Phi \setminus \{0\}$  it follows that  $u$  defines a strict weak local minimizer provided the strict Legendre condition is satisfied. Set

$$\begin{aligned} R &= f_{u'u'}(x, u(x), u'(x)), \\ P &= f_{uu}(x, u(x), u'(x)), \\ Q &= f_{uu'}(x, u(x), u'(x)). \end{aligned}$$

Suppose that  $u \in C^2[a, b]$ . This assumption is satisfied if  $u$  is a weak extremal and if  $R \neq 0$  on  $[a, b]$ , see Theorem 3.2.5 (regularity). Set

$$S = P - \frac{d}{dx}Q,$$

then the second variation is

$$\langle E''(u)\phi, \phi \rangle = \int_a^b (R\phi'^2 + S\phi^2) dx.$$

We recall that  $\phi(a) = \phi(b) = 0$ .

**Definition.** The Euler equation

$$Lv \equiv \frac{d}{dx}(Rv') - Sv = 0$$

associated to the second variation is called *Jacobi equation*.

Consider the initial value problem for the Jacobi equation

$$\begin{aligned} Lv &= 0 && \text{in } (a, b) \\ v(a) &= 0, \quad v'(a) = 1. \end{aligned} \tag{3.3}$$

We suppose that the strict Legendre condition  $f_{u'u'} > 0$  is satisfied on  $[a, b]$  and that there exists  $C^1$ -extensions of  $R$  and  $S$  onto  $C^1[a - \delta, b + \delta]$  for a (small)  $\delta > 0$ .

**Definition.** The lowest zero  $\zeta$ ,  $a < \zeta$ , of the solution of (3.3) is said to be *conjugate point* of  $a$  with respect to  $L$ .

**Theorem 3.2.8** (Necessary condition of Jacobi). *Assume  $\langle E''(u)\phi, \phi \rangle \geq 0$  for all  $\phi \in \Phi$  and  $f_{u'u'}(x, u(x), u'(x)) > 0$  on  $[a, b]$ . Then  $\zeta \geq b$ .*

*Proof.* If not, then  $a < \zeta < b$ . We construct a  $w \in H_0^1(a, b)$  such that  $\langle E''(u)\phi, \phi \rangle < 0$ . We choose a fixed  $h \in C^2[a, b]$  such that  $h(a) = h(b) = 0$ ,  $h(\zeta) > 0$ , for example  $h(x) = (x - a)(b - x)$  and define

$$w(x) = \begin{cases} v(x) + \kappa h(x) & \text{if } a \leq x \leq \zeta \\ \kappa h(x) & \text{if } \zeta < x \leq b \end{cases},$$

where  $v$  is the solution of the above initial value problem (3.3). The positive

constant  $\kappa$  will be determined later. Then

$$\begin{aligned}
\langle E''(u)w, w \rangle &= \int_a^\zeta (Rw'^2 + Sw^2) dx + \int_\zeta^b (Rw'^2 + Sw^2) dx \\
&= - \int_a^\zeta wLw dx + (Rw'w)(\zeta - 0) \\
&\quad - \int_\zeta^b wLw dx - (Rw'w)(\zeta + 0) \\
&= - \int_a^\zeta \kappa(v + \kappa h)Lw dx + \kappa R(\zeta)(v'(\zeta) + \kappa h'(\zeta))h(\zeta) \\
&\quad - \kappa^2 \int_\zeta^b hLh dx - \kappa^2 R(\zeta)h'(\zeta)h(\zeta) \\
&= \kappa R(\zeta)v'(\zeta)h(\zeta) - \kappa^2 \int_a^b hLh dx - \kappa \int_a^\zeta vLh dx \\
&= \kappa \left( 2R(\zeta)v'(\zeta)h(\zeta) - \kappa \int_a^b hLh dx \right) \\
&< 0
\end{aligned}$$

for all  $0 < \kappa < \kappa_0$ ,  $\kappa_0$  sufficiently small. We recall that  $R(\zeta) > 0$ ,  $v'(\zeta) < 0$  and  $h(\zeta) > 0$ .  $\square$

**Definition.** The inequality  $\zeta > b$  is called *strict Jacobi condition*.

If the strict Jacobi condition is satisfied, then there is a solution of the Jacobi equation which is positive on the closed interval  $[a, b]$ . Once one has such a positive solution then we can rewrite the second variation from which it follows immediately that this form is positive if  $\phi \neq 0$ .

**Lemma.** *Assume that the strict Jacobi condition is satisfied. Then there exists a solution  $v$  of the Jacobi equation such that  $v \neq 0$  on  $[a, b]$ .*

**Proof.** Consider the initial value problem  $Lv = 0$  on  $(a, b)$ ,  $v(a) = \alpha$ ,  $v'(a) = 1$ , where  $\alpha$  is a small positive constant. Let  $v(\alpha; x)$  be the solution and  $\zeta(\alpha)$  the lowest zero of  $v(\alpha; x)$ . Then  $\zeta(\alpha) \rightarrow \zeta(0)$  as  $\alpha \rightarrow 0$ , which is a result in the theory of ordinary differential equations (continuous dependence of solutions on data).  $\square$

Let  $z \in C^1[a, b]$  be an arbitrary function. Since

$$\frac{d}{dx}(z\phi^2) = 2z\phi\phi' + z'\phi^2$$

it follows for  $\phi \in \Phi$  that

$$\int (2z\phi\phi' + z'\phi^2) dx = 0.$$

Consequently

$$\langle E''(u)\phi, \phi \rangle = \int_a^b ((S + z')\phi^2 + 2z\phi\phi' + R\phi'^2) dx.$$

The integrand of the right hand side is a quadratic form  $\sum a_{ij}\zeta_i\zeta_j$ , where  $\zeta_1 = \phi'$ ,  $\zeta_2 = \phi$  and  $a_{11} = R$ ,  $a_{12} = z$ ,  $a_{22} = S + z'$ . Set  $\zeta = U(x)\eta$ , where  $U$  is orthogonal, then  $\sum a_{ij}\zeta_i\zeta_j = \lambda_1\eta_1^2 + \lambda_2\eta_2^2$ . The requirement that one of the eigenvalues of the matrix  $(a_{ij})$  is zero leads to

$$z^2 = R(S + z'), \quad (3.4)$$

which is a Riccati equation for  $z$ . Let  $V \in C^1[a, b]$ ,  $V \neq 0$  on  $[a, b]$ , then the substitution

$$z = -R\frac{V'}{V} \quad (3.5)$$

transforms the Riccati equation into the Jacobi equation  $LV = 0$  for  $V$ . On the other hand, let  $V \neq 0$  on  $[a, b]$ , then (3.5) is a solution of the Riccati equation (3.4). The transformation (3.5) is called *Legendre transformation*. Thus the second variation is

$$\langle E''(u)\phi, \phi \rangle = \int_a^b R \left( \phi' + \frac{z}{R}\phi \right)^2 dx, \quad (3.6)$$

since  $S + z' = z^2/R$ .

**Theorem 3.2.9.** *Suppose the strict Legendre condition  $R > 0$  on  $[a, b]$  and the strict Jacobi condition  $\zeta > b$  are satisfied. Then  $\langle E''(u)\phi, \phi \rangle > 0$  for all  $\phi \in \Phi$  which are not identically zero.*

*Proof.* From (3.6) it follows  $\langle E''(u)\phi, \phi \rangle \geq 0$  and " $=$ " if and only if  $\phi' + (z/R)\phi = 0$  on  $[a, b]$ . Since  $\phi(a) = 0$ , this differential equation implies that  $\phi$  is identically zero on  $[a, b]$ .  $\square$

### 3.2.2 Systems of equations

Set

$$E(v) = \int_a^b f(x, v(x), v'(x)) dx,$$

and  $v(x) = (v_1(x), \dots, v_m(x))$ ,  $v'(x) = (v'_1(x), \dots, v'_m(x))$ . Let

$$V = \{v \in C^1[a, b] : v(a) = u_a, v(b) = u_b\},$$

where  $u_a, u_b \in \mathbb{R}^m$  are given.

**Theorem 3.2.10.** *Suppose that  $u \in V$  is a  $C^2(a, b)$  local minimizer of  $E(v)$  in  $V$ , then  $u$  satisfies the system of Euler differential equations*

$$\frac{d}{dx} f_{u'_j} = f_{u_j}$$

for  $j = 1, \dots, m$ .

*Proof.* Exercise.

**Remark.** For systems we have some related definitions and results as for scalar equations. A weak extremal is in  $C^2[a, b]$  if

$$\det \left( f_{u'_i u'_k}(x, u(x), u'(x)) \right)_{i,j=1}^m \neq 0$$

on  $[a, b]$ , see an exercise. A  $u \in V$  is said to be a *weak extremal* if

$$\int_a^b \sum_{k=1}^m \left( f_{u'_k} \phi'_k + f_{u_k} \phi_k \right) dx = 0$$

for all  $\phi \in V - V$ . The condition

$$\sum_{i,k=1}^m f_{u'_i u'_k} \zeta_i \zeta_k \geq 0 \quad \text{for all } \zeta \in \mathbb{R}^m$$

is called *Legendre condition*, and is called *strict Legendre condition* if the left hand side is positive for all  $\mathbb{R}^m \setminus \{0\}$ . As in the scalar case it follows from  $E''(u)(\phi, \phi) \geq 0$  for all  $\phi \in V - V$  that the Legendre condition is satisfied, see an exercise.



Example: **Brachistochrone**

Consider the problem of a Brachistochrone, see Section 1.2.2, to find a regular curve from

$$V = \{(x(t), y(t)) \in C^1[t_1, t_2] : x'^2 + y'^2 \neq 0, \\ (x(t_1), y(t_1)) = P_1, (x(t_2), y(t_2)) = P_2\}$$

which minimizes the functional

$$E(x, y) = \int_{t_1}^{t_2} f(t, y, x', y') dt$$

in the class  $V$ , where

$$f = \frac{\sqrt{x'^2 + y'^2}}{\sqrt{y - y_1 + k}}.$$

For notations see Section 1.2.2. Since  $f_x = 0$ , it follows from an equation of the system of Euler's equations that  $(f_{x'})' = 0$ . Thus

$$f_{x'} = \frac{x'}{\sqrt{x'^2 + y'^2} \sqrt{y - y_1 + k}} = a, \quad (3.7)$$

with a constant  $a$ . Suppose that  $P_1$  and  $P_2$  are not on a straight line parallel to the  $y$ -axis, then  $a \neq 0$ . Let  $t = t(\tau)$  be the map defined by

$$\frac{x'(t)}{\sqrt{x'(t)^2 + y'(t)^2}} = \cos \tau. \quad (3.8)$$

Set  $x_0(\tau) = x(t(\tau))$  and  $y_0(\tau) = y(t(\tau))$ . From (3.7) we get

$$\begin{aligned} y_0(\tau) - y_1 + k &= \frac{1}{a^2} \cos^2 \tau \\ &= \frac{1}{2a^2} (1 + \cos(2\tau)). \end{aligned} \quad (3.9)$$

Equation (3.9) implies that

$$y_0'(\tau) = -2\alpha \sin(2\tau), \quad \alpha := 1/(2a^2),$$

and from (3.8) we see that

$$x_0'(\tau) = \pm 4\alpha \cos^2 \tau.$$

Set  $2\tau = u - \pi$ , then it follows that

$$\begin{aligned}x - x_1 + \beta &= \pm\alpha(u - \sin u) \\ y - y_1 + k &= \alpha(1 - \cos u),\end{aligned}$$

where  $(x_1, y_1) = P_1$  and  $\beta$  is a constant, and  $x(u) := x_0(\tau)$ ,  $y(u) := y_0(\tau)$ . Thus extremals are cycloids.

Consider the case where  $v_1 = 0$ ,  $P_1 = (0, 0)$ , and that  $P_2 = (x_2, y_2)$  satisfies  $x_2 > 0$  and  $y_2 > 0$ . Then

$$\begin{aligned}x &= \alpha(u - \sin u) \\ y &= \alpha(1 - \cos u),\end{aligned}$$

where  $0 \leq u \leq u_1$ . For given  $P_2 = (x_2, y_2)$  one finds  $u_1$  and  $\alpha$  from the nonlinear system

$$\begin{aligned}x_2 &= \alpha(u - \sin u) \\ y_2 &= \alpha(1 - \cos u),\end{aligned}$$

see an exercise.

### Example: N-body problem

Consider  $N$  mass points with mass  $m_i$  located at  $x^{(i)} = (x_1^{(i)}, x_2^{(i)}, x_3^{(i)}) \in \mathbb{R}^3$ . Set

$$U = - \sum_{i \neq j} \frac{m_i m_j}{|x^{(i)} - x^{(j)}|}$$

and consider the variational integral

$$E(x) = \int_{t_1}^{t_2} \left( \frac{1}{2} \sum_{i=1}^N m_i \left| \frac{dx^{(i)}}{dt} \right|^2 - U(x) \right) dt,$$

where  $x = (x^{(1)}, \dots, x^{(N)})$ . The associated system of the 3N Euler equations is

$$m_i \frac{d^2 x^{(i)}}{dt^2} = -\nabla_{x^{(i)}} U.$$

### 3.2.3 Free boundary conditions

In previous sections there are "enough" boundary conditions prescribed. In many problems some further conditions follow from variational considerations. A typical example is  $\min_{v \in V} E(v)$ , where

$$E(v) = \int_a^b f(x, v(x), v'(x)) dx + h(v(a), v(b)).$$

Here is  $V = C^1[a, b]$  and  $h(\alpha, \beta)$  is a sufficiently regular function. Let  $u$  be a local minimizer, then for fixed  $\phi \in V$

$$E(u) \leq E(u + \epsilon\phi)$$

for all  $\epsilon$ ,  $|\epsilon| < \epsilon_0$ ,  $\epsilon_0$  sufficiently small,

$$\begin{aligned} \int_a^b (f_u(x, u, u')\phi + f_{u'}(x, u, u')\phi') dx \\ + h_\alpha(u(a), u(b))\phi(a) + h_\beta(u(a), u(b))\phi(b) = 0 \end{aligned}$$

for all  $\phi \in V$ . Assume that  $u \in C^2(a, b)$ , then

$$\begin{aligned} \int_a^b \left( f_u - \frac{d}{dx} f_{u'} \right) \phi dx + [f_{u'}\phi]_a^b \\ + h_\alpha(u(a), u(b))\phi(a) + h_\beta(u(a), u(b))\phi(b) = 0. \end{aligned} \quad (3.10)$$

Since  $C_0^1(a, b) \subset V$ , it follows

$$\int_a^b \left( f_u - \frac{d}{dx} f_{u'} \right) \phi dx = 0$$

for all  $\phi \in C_0^1(a, b)$ , which implies that

$$f_u - \frac{d}{dx} f_{u'} = 0$$

on  $(a, b)$ . Then, from (3.10) we obtain

$$(f_{u'}\phi)(b) - (f_{u'}\phi)(a) + h_\alpha(u(a), u(b))\phi(a) + h_\beta(u(a), u(b))\phi(b) = 0$$

for all  $\phi \in C^1[a, b]$ . Choose a  $\phi$  such that  $\phi(b) = 0$  and  $\phi(a) = 1$ , it follows  $f_{u'} = h_\alpha$  at  $x = a$ , and take then a  $\phi$  such that  $\phi(b) = 1$ ,  $\phi(a) = 0$ , we obtain  $f_{u'} = -h_\beta$  at  $x = b$ .

These boundary conditions are called *free boundary conditions*. These conditions are not prescribed, they result from the property that  $u$  is a minimizer of the associated energy functional.

**Mixed boundary conditions**

If we choose  $V = \{v \in C^1[a, b] : v(a) = u_a\}$ , where  $u_a$  is prescribed, as the admissible comparison set instead of  $C^1[a, b]$ , then a local minimizer of  $E$  in  $V$  satisfies the weak Euler equation and the additional (free) boundary condition  $f_{u'} = -h_\beta$  at  $x = b$ .

*Proof.* Exercise.

**Higher order problems**

Set

$$E(v) = \int_a^b f(x, v(x), \dots, v^{(m)}(x)) dx$$

and let  $V = C^m[a, b]$  be the set of the admissible comparison functions. That is, no boundary conditions are prescribed. From  $u \in V : E(u) \leq E(v)$  for all  $v \in V$ ,  $\|v - u\|_{C[a, b]} < \epsilon$  for an  $\epsilon > 0$ , it follows the weak Euler equation

$$\int_a^b \sum_{k=0}^m f_{u^{(k)}}(x, u(x), \dots, u^{(m)}(x)) \phi^{(k)} dx = 0$$

for all  $\phi \in C^m[a, b]$ . Assume that  $u \in C^{2m}[a, b]$ , which is a regularity assumption on  $u$ , it follows by integration by parts the differential equation

$$\sum_{k=0}^m (-1)^k (f_{u^{(k)}})^{(k)} = 0$$

on  $(a, b)$  and the free boundary conditions  $(q_l)(a) = 0$ ,  $(q_l)(b) = 0$ ,  $l = 0, \dots, m - 1$ , where

$$q_l = \sum_{k=1}^{m-l} (-1)^{k-1} (f_{u^{(k+l)}})^{(k)}.$$

*Proof.* Exercise.

**Example: Bending of a beam.**

Consider the energy functional, see [33] for the related physics,

$$J(v) = \frac{1}{2} EI \int_0^l (v''(x))^2 dx - \int_0^l f(x)v(x) dx,$$

where  $v \in C^2[0, l]$ ,  $EI$  is a positive constant (bending stiffness), and  $f$  denotes the force per unit length, see Figure (i). The Euler equation is here

$$EIu^{(4)} = f \text{ on } (0, l).$$

and the prescribed and free boundary conditions depend on how the beam is supported, see the related figures.

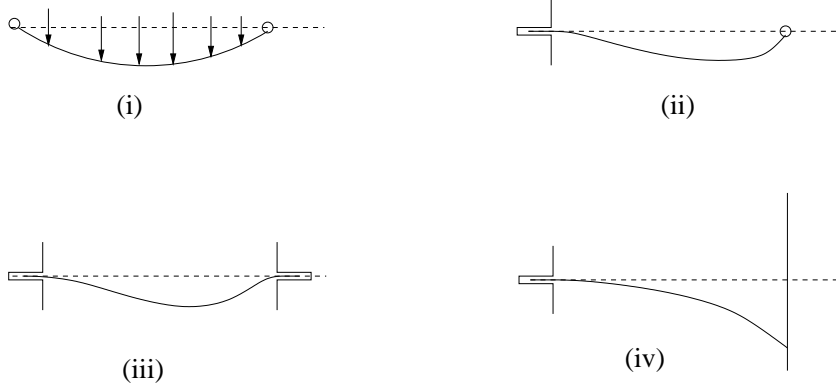

(i) *Simply supported at both ends.* Prescribed conditions:  $u(0) = 0$ ,  $u(l) = 0$ , free boundary conditions:  $u''(0) = 0$ ,  $u''(l) = 0$ .

(ii) *Clamped at both ends.* Prescribed conditions:  $u(0) = u'(0) = 0$ ,  $u(l) = u'(l) = 0$ , free boundary conditions: none.

(iii) *Clamped at one end and simply supported at the other end.* Prescribed conditions:  $u(0) = u'(0) = 0$ ,  $u(l) = 0$ , free boundary condition:  $u''(l) = 0$ .

(iv) *Clamped at one end, no prescribed conditions at the other end.* Prescribed conditions:  $u(0) = u'(0) = 0$ , free boundary conditions:  $u''(l) = 0$ ,  $u'''(l) = 0$ .

### 3.2.4 Transversality conditions

The condition which we will derive here is a generalization of the previous case (iv), where the right end of the curve can move freely on the target line which is parallel to the  $y$ -axis.

**Definition.** A curve  $\gamma$  in  $\mathbb{R}^2$  is said to be a *simple*  $C^1$ -curve if there is a parameter representation  $v(t) = (v_1(t), v_2(t))$ ,  $t_a \leq t \leq t_b$ ,  $t_a < t_b$ , such that  $v_i \in C^1[t_a, t_b]$ ,  $v_1'(t)^2 + v_2'(t)^2 \neq 0$  and  $v(t_1) \neq v(t_2)$  for all  $t_1, t_2 \in [t_a, t_b]$  satisfying  $t_1 \neq t_2$ .

**Remark.** A regular parameter transformation  $t = t(\tau)$ , i. e., a mapping  $t \in C^1[\tau_a, \tau_b]$  satisfying  $t(\tau_a) = t_a$ ,  $t(\tau_b) = t_b$  and  $t'(\tau) \neq 0$  on  $\tau_a \leq \tau \leq \tau_b$ ,  $\tau_a < \tau_b$ , maps a simply  $C^1$ -curve onto a simple  $C^1$ -curve.

*Proof.* Exercise.

Let  $\gamma = \gamma(\tau)$  be a given simple  $C^1$ -curve and consider the set

$$V = \{v : v = v(t), 0 \leq t \leq 1, \text{ simple } C^1 \text{ - curve, } v(0) = P, v(1) \in \gamma\},$$

where  $P \notin \gamma$  is given. Let  $v \in V$ , then we consider the functional

$$E(v) = \int_0^1 f(t, v(t), v'(t)) dt,$$

$f$  given and sufficiently regular. Set  $f_v = (f_{v_1}, f_{v_2})$  and  $f_{v'} = (f_{v'_1}, f_{v'_2})$ .

**Theorem 3.2.11.** *Suppose that  $u \in V \cap C^2[0, 1]$  is a local minimizer of  $E$  in  $V$ , then*

$$\begin{aligned} \frac{d}{dt}(f_{v'}) &= f_u \quad \text{on } (0, 1) \\ f_{v'}(1, u(1), u'(1)) &\perp \gamma. \end{aligned}$$

*Proof.* Let  $\tau_0$  such that  $u(1) = \gamma(\tau_0)$ . Since  $E(u) \leq E(v)$  for all  $v \in V_0$ , where

$$V_0 = \{v \in V : v(0) = P, v(1) = u(1)\},$$

it follows the system of Euler equations

$$f_u - \frac{d}{dt} f_{v'} = 0$$

in  $(0, 1)$ . The transversality condition is a consequence of variations along the target curve  $\gamma$ , see Figure 3.2. There is a family  $v(t, \tau)$  of curves such that  $v \in C^1(\overline{D})$ , where  $D = (0, 1) \times (\tau_0 - \epsilon_0, \tau_0 + \epsilon_0)$  for an  $\epsilon_0 > 0$ , and

$$v(t, \tau_0) = u(t), \quad v(0, \tau) = P, \quad v(1, \tau) = \gamma(\tau).$$

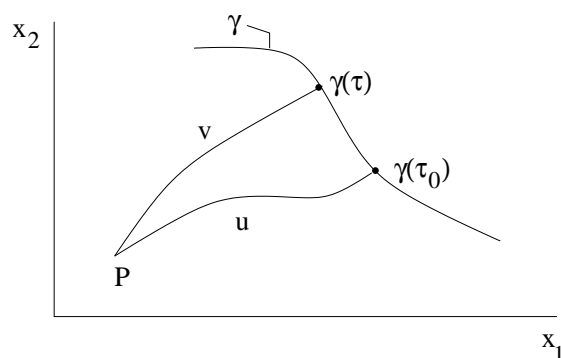

Figure 3.2: Admissible variations

For example, such a family is given by

$$v(t, \tau) = u(t) + (\gamma(\tau) - \gamma(\tau_0)) \eta(t),$$

where  $\eta(t)$ ,  $0 \leq t \leq 1$ , is a fixed  $C^1$ -function such that  $\eta(0) = 0$  and  $\eta(1) = 1$ .

Set  $g(\tau) = E(v)$ . Since  $g(\tau_0) \leq g(\tau)$ ,  $|\tau - \tau_0| < \epsilon_0$ , it follows that  $g'(\tau_0) = 0$ . Consequently

$$\int_0^1 (f_u \cdot v_\tau(t, \tau_0) + f_{u'} \cdot v'_\tau(t, \tau_0)) dt = 0,$$

where  $v' = v_t$ . Integration by parts yields

$$\int_0^1 \left( f_u - \frac{d}{dt} f_{u'} \right) \cdot v_\tau(t, \tau_0) dt + \left[ f_{u'} \cdot v_\tau(t, \tau_0) \right]_{t=0}^{t=1} = 0.$$

Since the system of Euler differential equations is satisfied and since  $v(0, \tau) = P$ ,  $|\tau - \tau_0| < \epsilon$ , it follows

$$f_{u'}(1, u(1), u'(1)) \cdot v_\tau(1, \tau_0) = 0.$$

Finally, we arrive at the result of the theorem since  $v(1, \tau) = \gamma(\tau)$ .  $\square$

**Remark 1.** If both ends move on curves  $\gamma_1$ ,  $\gamma_2$ , respectively, see Figure 3.3, then

$$f_{u'} \perp \gamma_1 \text{ at } t = 0, \text{ and } f_{u'} \perp \gamma_2 \text{ at } t = 1,$$

if  $u(0) \in \gamma_1$  and  $u(1) \in \gamma_2$ .

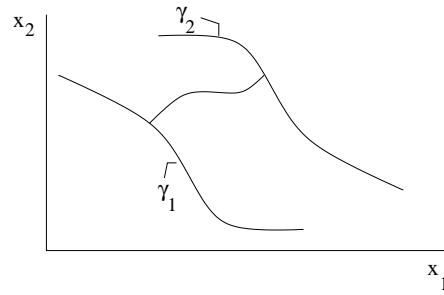

Figure 3.3: Both ends move on curves

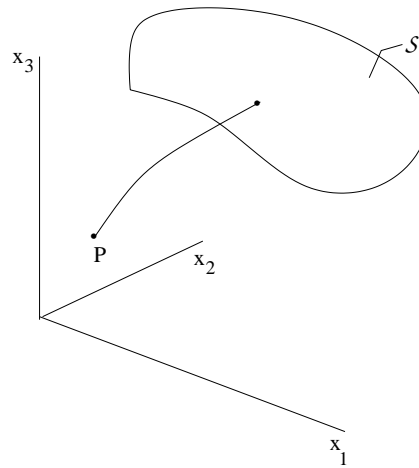

Figure 3.4: Target is a surface

*Proof.* Exercise.

**Remark 2.** The result of the theorem and of the above remark hold in  $\mathbb{R}^n$ .

*Proof.* Exercise.

**Remark 3.** Consider the case  $\mathbb{R}^3$  and let the target be a sufficiently regular surface  $\mathcal{S}$ , see Figure 3.4, then the transversality condition is  $f_{u'} \perp \mathcal{S}$ .

*Proof.* Exercise.



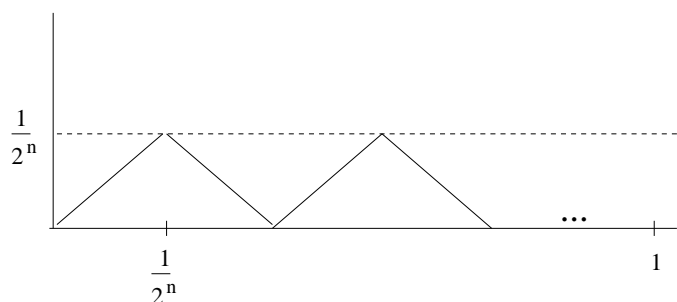

Figure 3.5: Nonsmooth solutions

### 3.2.5 Nonsmooth solutions

Under additionally assumptions extremals of variational problems associated to integrals of the type

$$\int_a^b f(x, v, v') dx \quad \text{or} \quad \int_{\Omega} F(x, v, \nabla v) dx$$

are smooth, that is they are at least in  $C^2$ . In general, it can happen that extremals have corners or edges, respectively, even if the integrands are analytically in their arguments.

**Example.** Consider the class

$$V = \{v \in C[0, 1] : v \text{ piecewise } C^1, v(0) = v(1) = 0\}.$$

A  $u \in C[a, b]$  is called piecewise in  $C^s$  if there are at most finitely many points  $0 < t_1 < t_2 \dots < t_m < 1$  such that  $u \in C^s[t_k, t_{k+1}]$ ,  $k = 0, \dots, m$ . Set  $t_0 = 0$  and  $t_{m+1} = 1$ . For  $v \in V$  let

$$E(v) = \int_0^1 (v'(x)^2 - 1)^2 dx.$$

There is a countable set of nonsmooth solutions, see Figure 3.5.

Let  $V$  be the class of functions  $v : [t_1, t_2] \mapsto \mathbb{R}^n$  in  $C[t_1, t_2]$ , piecewise in  $C^1$  and  $v(t_1) = u_1, v(t_2) = u_2$ , where  $u_1, u_2$  are given. Consider the functional

$$E(v) = \int_{t_1}^{t_2} f(t, v(t), v'(t)) dt,$$

where  $v \in V$  and  $f$  is given and sufficiently regular.

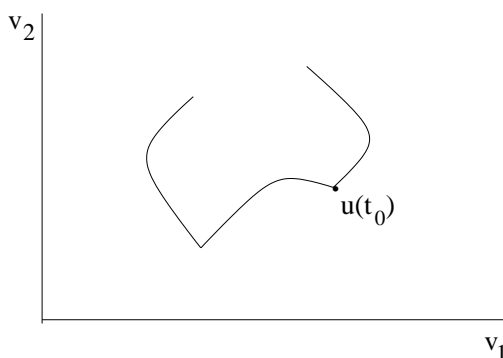

Figure 3.6: Corner of the extremal

Let  $u \in V$  be a weak extremal, that is,

$$\int_{t_1}^{t_2} (f_u \cdot \phi + f_{u'} \cdot \phi') dt = 0$$

for all  $\phi \in C_0^1(t_1, t_2)$ .

**Theorem 3.2.12** (Weierstrass-Erdmann corner condition). *Suppose that  $u \in V$  and in  $C^2$  on the closed subintervals where  $u$  is in  $C^1$ , and that  $u'$  is possibly discontinuous at  $t_0 \in (t_1, t_2)$ , see Figure 3.6, then*

$$[f_{u'}](t_0) \equiv f_{u'}(t, u(t), u'(t))|_{t_0+0} - f_{u'}(t, u(t), u'(t))|_{t_0-0} = 0.$$

*Proof.* Let  $\eta > 0$  small enough such that there is no further corner of the extremal in  $(t_0 - \eta, t_0 + \eta)$ . Then for all  $\phi \in C_0^1(t_0 - \eta, t_0 + \eta)$  we have, where  $a = t_0 - \eta$  and  $b = t_0 + \eta$ ,

$$\begin{aligned} 0 &= \int_a^b (f_u \cdot \phi + f_{u'} \cdot \phi') dt \\ &= \int_a^{t_0} (f_u \cdot \phi + f_{u'} \cdot \phi') dt + \int_{t_0}^b (f_u \cdot \phi + f_{u'} \cdot \phi') dt \\ &= \int_a^{t_0} \left( f_u - \frac{d}{dt} f_{u'} \right) \cdot \phi dt + f_{u'} \cdot \phi \Big|_a^{t_0} \\ &\quad + \int_{t_0}^b \left( f_u - \frac{d}{dt} f_{u'} \right) \cdot \phi dt + f_{u'} \cdot \phi \Big|_{t_0}^b \\ &= -[f_{u'}](t_0) \cdot \phi(t_0) \end{aligned}$$

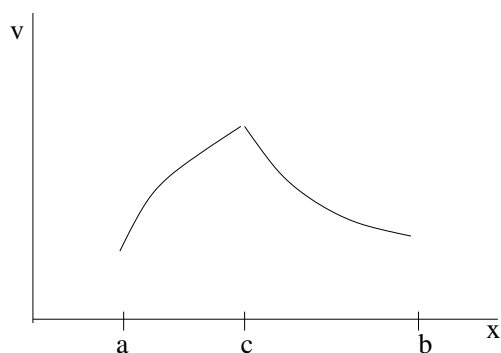

Figure 3.7: Corner of a graph extremal

for all  $\phi(t_0) \in \mathbb{R}^n$ . □

As a corollary we derive a related condition for nonparametric integrands. Set

$$E(v) = \int_a^b f(x, v(x), v'(x)) dx,$$

where  $v : [a, b] \mapsto \mathbb{R}$ ,  $v \in V$  and  $V$  is defined by

$$V = \{v \in C[a, b] : v \text{ piecewise in } C^1, v(a) = u_a, v(b) = u_b\}.$$

**Corollary.** *Suppose that  $u \in V$  satisfying  $u \in C^2[a, c]$  and  $u \in C^2[c, b]$ , where  $a < c < b$ , is a local minimizer of  $E$  in  $V$ , see Figure 3.7. Then*

$$[f_{u'}](c) = 0 \quad \text{and} \quad [f - u' f_{u'}](c) = 0.$$

*Proof.* The formal proof is to replace  $x$  through  $x = x(t)$ ,  $a \leq t \leq b$ , where  $x$  is a  $C^1$ -bijective mapping from  $[a, b]$  onto  $[a, b]$  such that  $x' \neq 0$  on  $[a, b]$ . Then

$$\int_a^b f(x, v(x), v'(x)) dx = \int_a^b f\left(x(t), y(t), \frac{y'(t)}{x'(t)}\right) x'(t) dt,$$

where  $y(t) = v(x(t))$ . Set

$$F(x, y, x', y') = f\left(x, y, \frac{y'}{x'}\right) x',$$

then  $[F_{x'}](c) = 0$  and  $[F_{y'}](c) = 0$ , which are the equations of the corollary.

The following consideration is a justification of that argument. Let  $u$  be a minimizer of  $E(v)$  in  $V$ . For fixed  $\phi_1, \phi_2 \in C_0^1(a, b)$  set

$$\begin{aligned}x(\epsilon; t) &= t + \epsilon\phi_1(t) \\y(\epsilon; t) &= u(t) + \epsilon\phi_2(t),\end{aligned}$$

where  $t \in [a, b]$ ,  $|\epsilon| < \epsilon_0$ ,  $\epsilon_0$  sufficiently small. Then  $x$  defines a  $C^1$  diffeomorphism from  $[a, b]$  onto  $[a, b]$  and  $x' \neq 0$  for each  $\epsilon$ ,  $|\epsilon| < \epsilon_0$ . Here we set  $x' = x'_t(\epsilon; t)$ . Let  $t = t(\epsilon; x)$  be the inverse of the first of the two equations above, and set

$$Y(\epsilon; x) = y(\epsilon; t(\epsilon; x)).$$

Then  $Y(\epsilon; x)$  defines a  $C^1[a, b]$  graph, i. e.,  $Y \in V$ , and

$$\begin{aligned}\int_a^b f(x, u(x), u'(x)) dx &\leq \int_a^b f(x, Y(\epsilon; x), Y'(\epsilon; x)) dx \\ &= \int_a^b f\left(x(\epsilon; t), y(\epsilon; t), \frac{y'(\epsilon; t)}{x'(\epsilon; t)}\right) x'(\epsilon; t) dt \\ &=: g(\epsilon).\end{aligned}$$

Since  $g(0) \leq g(\epsilon)$ ,  $|\epsilon| < \epsilon_0$ , it follows  $g'(0) = 0$  which implies the conditions of the corollary.  $\square$

**Remark.** The first condition of the corollary follows also by a direct application of the argument of the proof of Theorem 3.2.12. The second condition is a consequence of using a family of diffeomorphism of the fixed interval  $[a, b]$ , which are called sometimes “inner variations”.

There is an interesting geometric interpretation of the conditions of the corollary. Let  $u$  be an extremal and  $a < x_0 < b$ .

**Definition.** The function

$$\eta = f(x_0, u(x_0), \xi) =: h(\xi)$$

is called *characteristic* of  $f$  at  $(x_0, u(x_0))$ .

Let  $(\xi_i, \eta_i)$ ,  $i = 1, 2$ , two points on the characteristic curve of  $f$  at  $(c, u(c))$ ,  $a < c < b$ , and let  $T_i$  tangent lines of the characteristic curve at  $(\xi_i, \eta_i)$ , which are given by

$$\eta - \eta_i = f_{u'}(c, u(c), \xi_i)(\xi - \xi_i).$$

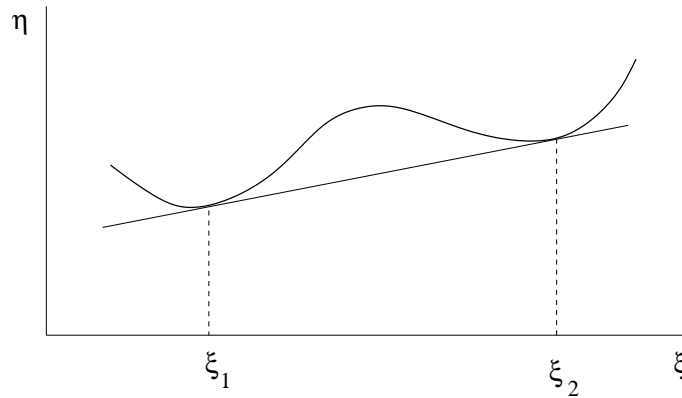

Figure 3.8: Geometric meaning of the Corollary

Set

$$\begin{aligned}\xi_1 &= (u')^- \equiv u'(c-0), & \xi_2 &= (u')^+ \equiv u'(c+0) \\ \eta_1 &= f^- \equiv f(c, u(c), u'(c-0)), & \eta_2 &= f^+ \equiv f(c, u(c), u'(c+0))\end{aligned}$$

and

$$f_{u'}^- = f_{u'}(c, u(c), (u')^-), \quad f_{u'}^+ = f_{u'}(c, u(c), (u')^+).$$

Then the two tangent lines are given by

$$\begin{aligned}\eta - f^- &= f_{u'}^-(\xi - (u')^-) \\ \eta - f^+ &= f_{u'}^+(\xi - (u')^+).\end{aligned}$$

From the first condition of the corollary we see that the tangent lines must be parallel, then the second condition implies that the lines coincides, see Figure 3.8.

As a consequence of this consideration we have:

*Suppose that  $h(\xi) = f(x, u, \xi)$  is strongly convex or strongly concave for all  $(x, u) \in [a, b] \times \mathbb{R}$ , then there are no corners of extremals.*

*Proof.* If not, then there are  $\xi_1 \neq \xi_2$  which implies the situation shown in Figure 3.8.  $\square$

Thus, extremals of variational problems to the integrands  $f = v'^2$  or  $f = a(x, y)\sqrt{1 + v'^2}$ ,  $a > 0$ , have no corners. If the integrand is not convex for

all  $v'$ , then corners can occur as the example  $f = (v'^2 - 1)^2$  shows, see Figure 3.5.

### 3.2.6 Equality constraints; functionals

In 1744 Euler considered the variational problem  $\min_{v \in V} E(v)$ , where

$$E(v) = \int_a^b f(x, v(x), v'(x)) \, dx,$$

$v = (v_1, \dots, v_n)$ . Let

$$V = \{v \in C^1[a, b] : v(a) = u_a, v(b) = u_b, g_k(v) = 0, k = 1, \dots, m\}$$

for given  $u_a, u_b \in \mathbb{R}^n$ , and define  $g_k$  by

$$g_k(v) = \int_a^b l_k(x, v(x), v'(x)) \, dx.$$

The functions  $f$  and  $l_k$  are given and sufficiently regular.

Example: **Area maximizing**

Set

$$E(v) = \int_a^b v(x) \, dx$$

and

$$V = \{v \in C^1[a, b] : v(a) = u_a, v(b) = u_b, g(v) = L\},$$

where

$$g(v) = \int_a^b \sqrt{1 + v'^2(x)} \, dx$$

is the given length  $L$  of the curve defined by  $v$ . We assume that

$$c > \sqrt{(b-a)^2 + (u_b - u_a)^2}.$$

Then we consider the problem  $\max_{v \in V} E(v)$  of maximizing the area  $|\Omega|$  between the  $x$ -axis and the curve defined by  $v \in V$ , see Figure 3.9.

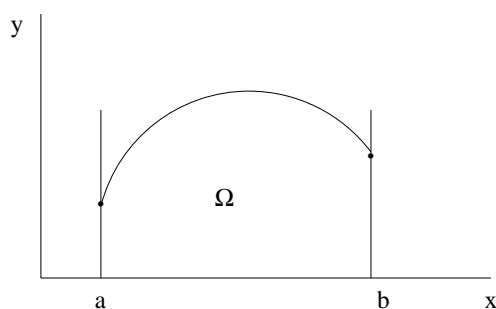

Figure 3.9: Area maximizing

**Example: Capillary tube**

This problem is a special case of a more general problem, see Section 1.3.3. It is also a problem which is governed by a partial differential equation, but it is covered by the Lagrange multiplier rule below. Consider a capillary tube with a bottom and filled partially with a liquid. The gravity  $g$  is directed downward in direction of the negative  $x_3$ -axis. The interface  $\mathcal{S}$ , which separates the liquid from the vapour, is defined by  $x_3 = v(x)$ ,  $x = (x_1, x_2)$ , see Figure 3.10. Set

$$V = \left\{ v \in C^1(\bar{\Omega}) : \int_{\Omega} v \, dx = \text{const.} \right\},$$

that is we prescribe the volume of the liquid. Let

$$E(v) = \int_{\Omega} \left( \sqrt{1 + |\nabla v|^2} + \frac{\kappa}{2} v^2 \right) dx - \cos \gamma \int_{\partial\Omega} v \, ds,$$

where  $\kappa$  is a positive constant (capillary constant) and  $\gamma$  is the angle between the normals on the cylinder wall and on the capillary surface  $\mathcal{S}$  at the boundary of  $\mathcal{S}$ . Then the variational problem is  $\min_{v \in V} E(v)$ .

A large class of problems fit into the following framework. Suppose that  $E : B \mapsto \mathbb{R}$  and  $g_j : B \mapsto \mathbb{R}$ ,  $j = 1, \dots, m$ . We recall that  $B$  is a real Banach space and  $H$  a real Hilbert space such that  $B \subset H$  is continuously embedded:  $\|v\|_H \leq c\|v\|_B$  for all  $v \in B$ . Moreover, we suppose that  $\|v\|_B \neq 0$  implies  $\|v\|_H \neq 0$  for  $v \in B$ , that is,  $B \subset H$  is injectively embedded.

Assumptions: (i) The functionals  $E$  and  $g_j$  are Fréchet differentiable at  $u \in B$ .

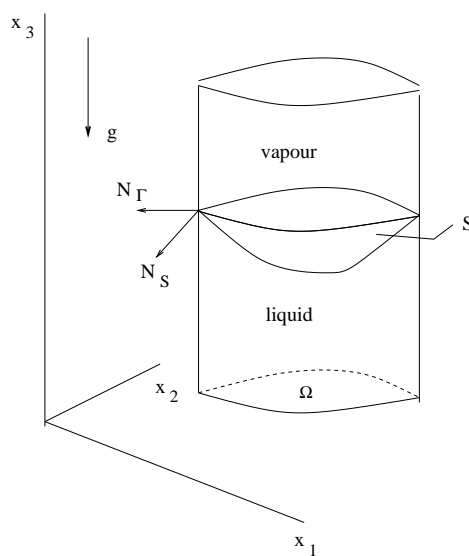

Figure 3.10: Capillary tube

(ii) For fixed  $u \in B$  and given  $\phi_1, \dots, \phi_m \in B$  the functions

$$F(c) = E\left(u + \sum_{j=1}^m c_j \phi_j\right)$$

$$G_i(c) = g_i\left(u + \sum_{j=1}^m c_j \phi_j\right)$$

are in  $C^1$  in a neighbourhood of  $c = 0$ ,  $c \in \mathbb{R}^m$ .

Set

$$V = \{v \in B : g_i(v) = 0, i = 1, \dots, m\}.$$

**Definition.** A  $u \in V$  is said to be a *local minimizer with respect to  $m$ -dimensional variations* of  $E$  in  $V$  if for given  $\phi_1, \dots, \phi_m \in B$  there exists an  $\epsilon > 0$  such that  $E(u) \leq E(v)$  for all  $v \in V$  satisfying  $v - u \in \text{span}\{\phi_1, \dots, \phi_m\}$  and  $\|u - v\|_B < \epsilon$ .

**Theorem 3.2.13** (Lagrange multiplier rule). *Let  $u \in V$  be a local minimizer or maximizer with respect to  $m$ -dimensional variations of  $E$  in  $V$ . Then*



there exists  $m + 1$  real numbers, not all of them are zero, such that

$$\lambda_0 E'(u) + \sum_{i=1}^m \lambda_i g'_i(u) = 0_{B^*}.$$

*Proof.* We will show by contradiction that the functionals  $l_0 = E'(u)$ ,  $l_1 = g'_1(u), \dots, l_m = g'_m(u)$  are linearly dependent in  $B$ . Suppose that these functionals are linearly independent, then there are  $\phi_j \in B$ ,  $j = 0, 1, \dots, m$ , such that  $l_i(\phi_j) = \delta_{ij}$ , see for example [28]. Set  $M = E(u)$  and consider for small  $\eta \in \mathbb{R}$  and  $c \in \mathbb{R}^m$  the system of  $m + 1$  equations

$$\begin{aligned} F(c) : &= E(u + \sum_{j=0}^m c_j \phi_j) = M + \eta \\ G_i(c) : &= g_i(u + \sum_{j=0}^m c_j \phi_j) = 0. \end{aligned}$$

Set  $A(c, \eta) = (F(c) - M - \eta, G_1(c), \dots, G_m(c))^T$ , then we can write the above system as  $A(c, \eta) = 0_{m+1}$ . We have  $A(0, 0) = 0_{m+1}$ , and, if the functionals  $l_0, \dots, l_m$  are linearly independent, that the  $m \times m$ -matrix  $A_c(0, 0)$  is regular. From the implicit function theorem we obtain that there exists an  $\eta_0 > 0$  and a  $C^1(-\eta_0, \eta_0)$  function  $c(\eta)$  such that  $c(0) = 0$  and  $A(c(\eta), \eta) \equiv 0$  on  $-\eta_0 < \eta < \eta_0$ . Then we take an  $\eta < 0$  from this interval and obtain a contradiction to the assumption that  $u$  is local minimizer of  $E$  in  $V$ , if  $u$  is a maximizer, then we choose a positive  $\eta$ .  $\square$

**Corollary.** *If  $g'_1(u), \dots, g'_m(u)$  are linearly independent, then  $\lambda_0 \neq 0$ .*

### 3.2.7 Equality constraints; functions

Set

$$E(v) = \int_a^b f(x, v(x), v'(x)) dx,$$

where  $v = (v_1, \dots, v_n)$ , and

$$\begin{aligned} V = & \{v \in C^1[a, b] : v(a) = u_a, v(b) = u_b, \\ & l_k(x, v(x)) = 0 \text{ on } [a, b], k = 1, \dots, m\} \end{aligned}$$

$u_a, u_b \in \mathbb{R}^n$ , and  $l_k$  and  $f$  are given sufficiently regular functions. We assume  $m < n$ . The problem  $\min_{v \in V} E(v)$  is called *Lagrange problem*.

Set

$$F(x, v, v', \lambda) = f(x, v, v') + \sum_{k=1}^m \lambda_k l_k(x, v).$$

**Theorem 3.2.14** (Lagrange multiplier rule). *Let  $u$  be a local minimizer or maximizer of  $E$  in  $V$ . Suppose that a fixed  $(m \times m)$ -submatrix of  $l_v(x, u(x))$  is regular for all  $x \in [a, b]$ . Then there are functions  $\lambda_l \in C^1[a, b]$  such that*

$$\frac{d}{dx} F_{v'} = F_u$$

on  $(a, b)$ .

*Proof.* Suppose that

$$\frac{\partial(l_1, \dots, l_m)}{\partial(v_1, \dots, v_m)} \Big|_{v=u(x)}$$

is regular for all  $x \in [a, b]$ . Choose  $n - m$  functions  $\eta_{m+r} \in C^1$ ,  $r = 1, \dots, n - m$ , satisfying  $\eta_{m+r}(a) = 0$ ,  $\eta_{m+r}(b) = 0$ . Set

$$w_{m+r}(x, \epsilon) = u_{m+r}(x) + \epsilon \eta_{m+r}(x),$$

where  $|\epsilon| < \epsilon_0$ ,  $\epsilon_0$  sufficiently small, and consider on  $[a, b]$  the system

$$l_k(x, v_1, \dots, v_m, w_{m+1}(x, \epsilon), \dots, w_n(x, \epsilon)) = 0,$$

$k = 1, \dots, m$ , for the unknowns  $v_1, \dots, v_m$ . From the implicit function theorem we get solutions  $v_l = w_l(x, \epsilon)$ ,  $l = 1, \dots, m$ ,  $v_l \in C^1$  on  $[a, b] \times (-\epsilon_0, \epsilon_0)$  satisfying  $v_l(x, 0) = u_l(x)$  on  $[a, b]$ . These solutions are uniquely determined in a  $C$ -neighbourhood of  $u(x)$ . Thus  $l_k(x, w(x, \epsilon)) = 0$  on  $[a, b]$  for every  $k = 1, \dots, m$ . We have

$$w_{m+r}(a, \epsilon) = u_{m+r}(a), \quad w_{m+r}(b, \epsilon) = u_{m+r}(b). \quad (3.11)$$

Hence, since the above solution is unique, we obtain for  $k = 1, \dots, m$  that

$$w_k(a, \epsilon) = u_k(a), \quad w_k(b, \epsilon) = u_k(b). \quad (3.12)$$

Thus  $w(x, \epsilon)$  is an admissible family of comparison functions. Set

$$\eta_l(x) = \frac{\partial w_l}{\partial \epsilon} \Big|_{\epsilon=0}.$$

From (3.11) and (3.12) we get for  $l = 1, \dots, n$  that

$$\eta_l(a) = 0, \quad \eta_l(b) = 0. \quad (3.13)$$

Set

$$h(\epsilon) = \int_a^b f(x, w(x, \epsilon), w'(x, \epsilon)) \, dx.$$

Since  $h'(0) = 0$ , we see that

$$\int_a^b \left( \sum_{l=1}^n f_{u_l} \eta_l + f_{u'_l} \eta'_l \right) \, dx = 0. \quad (3.14)$$

From  $l_k(x, w(x, \epsilon)) = 0$  on  $[a, b] \times (-\epsilon_0, \epsilon_0)$  we obtain

$$\sum_{j=1}^n \frac{\partial l_k}{\partial v_j} \eta_j = 0, \quad k = 1, \dots, m.$$

Multiplying these equations with functions  $\lambda_k \in C[a, b]$ , we get

$$\sum_{j=1}^n \int_a^b \lambda_k(x) \frac{\partial l_k}{\partial v_j} \eta_j \, dx = 0, \quad (3.15)$$

$k = 1, \dots, m$ . We add equations (3.14) and (3.15) and arrive at

$$\int_a^b \sum_{j=1}^n \left( F_{u_j} \eta_j + F_{u'_j} \eta'_j \right) \, dx = 0,$$

where  $F = f + \sum_{k=1}^m \lambda_k l_k$ . We recall that  $l_k$  are independent of  $u'$ . Suppose for a moment that  $\lambda_k \in C^1[a, b]$ , then

$$\int_a^b \sum_{j=1}^n \left( F_{u_j} - \frac{d}{dx} F_{u'_j} \right) \eta_j \, dx = 0 \quad (3.16)$$

Since we can not choose the functions  $\eta_j$  arbitrarily, we determine the  $m$  functions  $\lambda_k$  from the system

$$F_{u_i} - \frac{d}{dx} F_{u'_i} = 0, \quad i = 1, \dots, m.$$

That is from the system

$$f_{u_i} - \frac{d}{dx} f_{u'_i} + \sum_{k=1}^m \lambda_k l_{k,u_i} = 0,$$

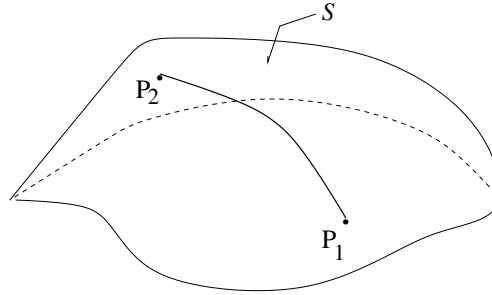

Figure 3.11: Geodesic curve

$i = 1, \dots, m$ . It follows that  $\lambda_k \in C^1[a, b]$ . Then (3.16) reduces to

$$\int_a^b \sum_{r=1}^{n-m} \left( F_{u_{m+r}} - \frac{d}{dx} F_{u'_{m+r}} \right) \eta_{m+r} dx = 0.$$

Since we can choose  $\eta_{m+r}$  arbitrarily, the theorem is shown.  $\square$

#### Example: Geodesic curves

Consider a surface  $\mathcal{S}$  defined by  $\phi(v) = 0$ , where  $\phi: \mathbb{R}^3 \mapsto \mathbb{R}$  is a  $C^1$ -function satisfying  $\nabla\phi \neq 0$ . Set

$$V = \{v \in C^1[t_1, t_2] : v(t_1) = P_1, v(t_2) = P_2, \phi(v) = 0\}.$$

Then we are looking for the shortest curve  $v \in V$  which connects two given points  $P_1$  and  $P_2$  on  $\mathcal{S}$ , see Figure 3.11. The associated variational integral which is to minimize in  $V$  is

$$E(v) = \int_{t_1}^{t_2} \sqrt{v'(t) \cdot v'(t)} dt.$$

A regular extremal satisfies

$$\frac{d}{dt} \left( \frac{u'}{\sqrt{u' \cdot u'}} \right) = \lambda \nabla\phi.$$

Choose the arc length  $s$  instead of  $t$  in the parameter representation of  $u$ , then

$$u''(s) = \lambda(s)(\nabla\phi)(u(s)),$$

which means that the principal normal is perpendicular on the surface  $\mathcal{S}$ , provided the curvature is not zero.

We recall that  $\nabla\phi \perp \mathcal{S}$ , and that the principal curvature is defined by  $u''(s)/\kappa(s)$ , where  $\kappa(s) = \|u''(s)\|$  (Euclidean norm of  $u''$ ) is the curvature.

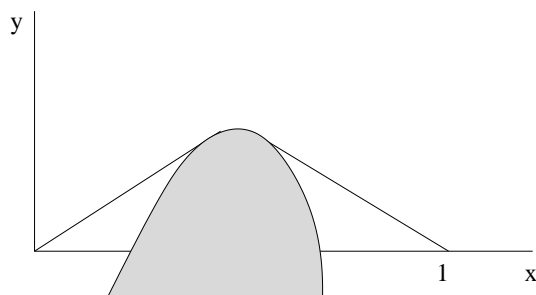

Figure 3.12: String above an obstacle

### 3.2.8 Unilateral constraints

Let  $u, h \in B$ ,  $E : B \mapsto \mathbb{R}$ , and assume the expansion

$$E(u + h) = E(u) + \langle E'(u), h \rangle + \eta(\|h\|_B) \|h\|_H \quad (3.17)$$

as  $\|h\|_B \rightarrow 0$ , where  $\lim_{t \rightarrow 0} \eta(t) = 0$  and  $\langle E'(u), h \rangle$  is a bounded linear functional on  $B$  which admits an extension to a bounded linear functional on  $H$ .

Let  $V \subset B$  nonempty and suppose that  $u \in V$  is a weak local minimizer of  $E$  in  $V$ . Then, see Theorem 3.2.1.

$$\langle E'(u), w \rangle \geq 0 \quad \text{for all } w \in T(V, u).$$

If  $V$  is a convex set, then

$$\langle E'(u), v - u \rangle \geq 0 \quad \text{for all } v \in V.$$

since  $v - u \in T(V, u)$  if  $v \in V$ .

**Example: String above an obstacle**

Let

$$V = \{v \in C^1[0, 1] : v(0) = v(1) = 0 \text{ and } v(x) \geq \psi(x) \text{ on } (0, 1)\},$$

where  $\phi \in C^1[0, 1]$  is given and satisfies  $\phi(0) \leq 0$  and  $\phi(1) \leq 0$ , see Figure 3.12. Set

$$E(v) = \int_0^1 (v'(x))^2 dx,$$

and consider the variational problem  $\min_{v \in V} E(v)$ . Suppose that  $u$  is a solution, then  $u$  satisfies the variational inequality

$$u \in V : \int_0^1 u'(x)(v(x) - u(x))' dx \text{ for all } v \in V.$$

**Remark.** The existence follows when we consider the above problem in the associated convex set in the Sobolev space  $H_0^1(0, 1)$ . Then we find a weak solution  $u \in H_0^1(0, 1)$  satisfying  $u(x) \geq \psi(x)$  on  $(0, 1)$ . Then from a regularity result due to Frehse [17] we find that  $u \in C^1[0, 1]$ , provided  $\psi$  is sufficiently regular. Such kind of results are hold also for more general problems, in particular, for obstacle problems for the beam, the membran, the minimal surface or for plates and shells.

#### Example: A unilateral problem for the beam

The following problem was studied by Link [32].<sup>2</sup> Consider a simply supported beam compressed by a force  $P$  along the negative  $x$ -axis, where the deflections are restricted by, say, a parallel line to the  $x$ -axis, see Figure 3.13. It turns out that  $u(k; x)$  defines a local minimizer of the associated energy functional

$$J(v) = \frac{1}{2}EI \int_0^l v''(x)^2 dx - \frac{P}{2} \int_0^l v'(x)^2 dx,$$

where  $EI$  is a positive constant (bending stiffness), in the set

$$V = \{v \in H_0^1(0, l) \cap H^2(0, l) : v(x) \leq d \text{ on } (0, l)\}$$

of admissible deflections if  $l/4 < k < l/2$  and it is no local minimizer if  $0 < k < l/4$ , see Section 3.3.3 or [40].

**Remark.** Related problems for the circular plate and the rectangular plate were studied in [43, 44], where explicit stability bounds were calculated.

---

<sup>2</sup>I would like to thank Rolf Klötzler for showing me this problem.

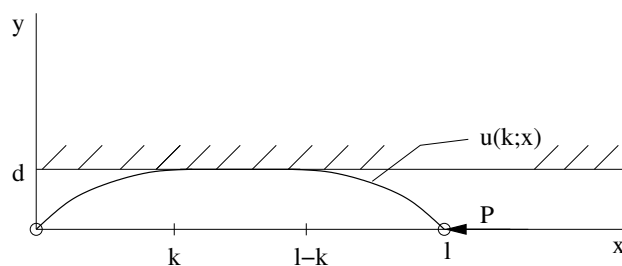

Figure 3.13: A unilateral beam

Example: **Positive solutions of eigenvalue problems**

Consider the eigenvalue problem

$$-\frac{d}{dx}(p(x)u'(x)) + q(x)u(x) = \lambda\rho(x)u(x) \text{ in } (a, b)$$

$$u(a) = u(b) = 0.$$

We suppose that  $p \in C^1[a, b]$ ,  $q, \rho \in C[a, b]$ , and that  $p, q$  and  $\rho$  are positive on the finite interval  $[a, b]$ . Set

$$a(u, v) = \int_a^b (p(x)u'(x)v'(x) + q(x)u(x)v(x)) \, dx$$

$$b(u, v) = \int_a^b \rho(x)u(x)v(x) \, dx.$$

Then the lowest eigenvalue  $\lambda_H$ , which is positive, is given by

$$\lambda_H = \min_{v \in H \setminus \{0\}} \frac{a(v, v)}{b(v, v)},$$

where  $H = H_0^1(a, b)$ . Then we ask whether or not the associated eigenfunction does not change sign in  $(a, b)$ . In our case of this second order problem for an ordinary differential equation it can be easily shown that each eigenvalue is simple. Instead of looking for minimizers of the above Rayleigh quotient in  $H$ , we pose the problem directly in the set of nonnegative functions. Define the closed convex cone with vertex at the origin

$$K = \{v \in H_0^1(a, b) : v(x) \geq 0 \text{ on } (a, b)\}.$$

Let

$$\lambda_K = \min_{v \in K \setminus \{0\}} \frac{a(v, v)}{b(v, v)}.$$

As in Chapter 2 we find that  $\lambda_K$  is the lowest eigenvalue of the variational inequality

$$u \in H \setminus \{0\} : a(u, v - u) \geq \lambda b(u, v - u) \text{ for all } v \in H.$$

Under the above assumptions we have

**Proposition.**  $\lambda_H = \lambda_K$ .

*Proof.* It remains to show that  $\lambda_H \geq \lambda_K$ . Let  $u_H$  be an eigenfunction to  $\lambda_H$ , then

$$a(u_H, v) = \lambda_H b(u_H, v) \text{ for all } v \in H. \quad (3.18)$$

Moreau's decomposition lemma, see Section 2.6.3, says that  $u_H = u_1 + u_2$ , where  $u_1 \in K$ ,  $u_2 \in K^*$  and  $a(u_1, u_2) = 0$ . We recall that  $K^*$  denotes the polar cone associated to  $K$ . Inserting  $v = u_1$  into (3.18), we get

$$\begin{aligned} a(u_1, u_1) &= \lambda_H b(u_1, u_1) + \lambda_H b(u_2, u_1) \\ &\leq \lambda_H b(u_1, u_1) \end{aligned}$$

since  $b(u_2, u_1) \leq 0$ , see an exercise. If  $u_1 \neq 0$ , then it follows that  $\lambda_K \leq \lambda_H$ . If  $u_1 = 0$ , then  $u_H \in K^*$ , which implies that  $-u_H \in K$ , see an exercise.  $\square$

**Remark.** The associated eigenfunction has no zero in  $(a, b)$ .

**Remark.** One can apply this idea to more general eigenvalue problems. In particular it can be shown that the first eigenvalue of a convex simply supported plate is simple and the associated eigenfunction has no zero inside of the convex domain  $\Omega \subset \mathbb{R}^2$ , see [39]. Plate problems are governed by fourth order elliptic equations.



## 3.2.9 Exercises

1. Consider the example "How much should a nation save?" Show that

$$\begin{aligned} \langle E''(K)\zeta, \zeta \rangle &\equiv \int_0^T (F_{KK}\zeta^2 + 2F_{KK'}\zeta\zeta' + F_{K'K'}\zeta'^2) dt \\ &\leq 0 \end{aligned}$$

for all  $K \in V$  and for all  $\zeta \in V - V$ . If additionally  $f'' < 0$  is satisfied, then

$$\langle E''(K)\zeta, \zeta \rangle \leq -c(K, T) \int_0^T \zeta^2 dt$$

for all  $K \in V$  and for all  $\zeta \in V - V$ ,  $c(K, T)$  is a positive constant.

2. Consider the example "How much should a nation save?". Find all extremals if

$$U(C) = \frac{1}{1-v} C^{1-v} \quad \text{and} \quad f(K) = bK,$$

where  $v \in (0, 1)$  and  $b$  are constants. Suppose that  $b \neq (b - \rho)/v$ .

3. Suppose that  $l_1, \dots, l_N$  are linearly independent functionals on a Hilbert space  $H$ . Show that there are  $v_1, \dots, v_N \in H$  such that  $l_i(v_j) = \delta_{ij}$ .
4. Consider the example of area maximizing of Section 3.2.6. Show that  $\lambda_0 \neq 0$ , where  $\lambda_0$  and  $\lambda_1$  are the Lagrange multipliers according to the Lagrange multiplier rule of Theorem 3.2.1.
5. Consider the example of the capillary tube of Section 3.2.6. Show that  $\lambda_0 \neq 0$ , where  $\lambda_0$  and  $\lambda_1$  are the Lagrange multipliers according to the Lagrange multiplier rule of Theorem 3.2.1.
6. Weierstraß. Show that the integral

$$\int_a^b f(x(t), x'(t)) dt,$$

where  $x(t) = (x_1(t), \dots, x_n(t))$ , is invariant with respect to a regular parameter transformation  $t = t(\tau)$ , that is,  $t \in C^1$  and  $t' > 0$ , if and only if  $f(x, p)$  is positive homogeneous in  $p$ , i. e.,  $f(x, \lambda p) = \lambda f(x, p)$  for all positive real  $\lambda$ .

*Hint:* To show that it follows that  $f(x, p)$  is positive homogeneous, differentiate the integral with respect to the upper bound  $\tau_b$  and then consider the mapping  $t = \tau/\lambda$ , where  $\lambda$  is a positive constant.

7. Show that a solution of the weak Euler equation of the vector valued variational problem, see Section 3.2.2, is in  $C^2[a, b]$  if

$$\det \left( f_{u'_i u'_k}(x, u(x), u'(x)) \right)_{i,k=1}^m \neq 0$$

on  $[a, b]$ .

8. Consider the case of a system, see Section 3.2.2, and show that

$$\langle E''(u)\phi, \phi \rangle \geq 0$$

for all  $\phi \in V - V$  implies the Legendre condition

$$\sum_{i,k=1}^m f_{u'_i u'_k} \zeta_i \zeta_k \geq 0 \quad \text{for all } \zeta \in \mathbb{R}^m.$$

*Hint:* Set  $\phi_l = \zeta_l \phi_h(x)$ , where  $\zeta \in \mathbb{R}^m$  and  $\phi_h$  is the function defined in the proof of Theorem 3.2.7.

9. Find the Brachistochrone if  $P_1 = (0, 0)$ ,  $P_2 = (1, 1)$  and  $v_1 = 0$ .
10. Determine the shortest distance between two straight lines in  $\mathbb{R}^3$ .
11. Find the shortest distance between the  $x$ -axis and the straight line defined by  $x + y + z = 1$  and  $x - y + z = 2$ .
12. Find the the shortest distance between the origin and the surface (rotational paraboloid) defined by  $z = 1 - x^2 - y^2$ .
13. Let

$$E(v) = \int_{t_1}^{t_2} g(v(t)) \sqrt{v'(t) \cdot v'(t)} dt,$$

$v = (v_1, v_2)$  and  $g$  is continuous. Show that the corner points of extremals are contained in the set  $\{(x_1, x_2) \in \mathbb{R}^2 : g(x_1, x_2) = 0\}$ .

14. Let  $u$  be a solution of the isoperimetric problem

$$\max_{v \in V} \int_0^1 v(x) dx,$$

where  $V = \{v \in C^1[a, b] : v(0) = v(1) = 0, l(v) = \pi/2\}$  with  $l(v) = \int_0^1 \sqrt{1 + (v'(x))^2} dx$ .

Find  $u$ .

15. Let  $u$  be a solution of the isoperimetric problem

$$\min_{v \in V} \int_0^1 \sqrt{1 + (v'(x))^2} dx,$$

where  $V = \{v \in C^1[a, b] : v(0) = v(1) = 0, l(v) = \pi/8\}$  with  $l(v) = \int_0^1 v(x) dx$ .

Find  $u$ .

16. A geodesic on a surface defined by  $\phi(x) = 0$ ,  $x \in \mathbb{R}^3$  and  $\nabla\phi \neq 0$  satisfies, see Section 3.2.7,

$$u''(s) = \lambda(s)(\nabla\phi)(u(s)).$$

Find  $\lambda$ .

17. Find geodesics  $u(s)$ ,  $0 \leq s \leq L$ , of length  $0 < L < \pi R$  on a sphere with radius  $R$ .

Consider geodesics  $x(s) = (x_1(s), x_2(s), x_3(s))$  on an ellipsoid  $\mathcal{E}$ , defined by

$$\left(\frac{x_1}{a}\right)^2 + \left(\frac{x_2}{b}\right)^2 + \left(\frac{x_3}{c}\right)^2 = 1,$$

where  $a, b, c$  are positive constants. Let

$$P_1, P_2 \in \mathcal{E} \cap \{x \in \mathbb{R}^3 : x_1 = 0\}.$$

Show that a geodesic connecting  $P_1$  and  $P_2$ ,  $P_1 \neq P_2$ , satisfies  $x_1(s) \equiv 0$ .

18. Set

$$V = \{v \in C^1[-1, -1] : v(-1) = v(1) = 0, v(x) \geq -x^2 + 1/4 \text{ on } (-1, 1)\}.$$

Find the solution of

$$\min_{v \in V} \int_{-1}^1 (v'(x))^2 dx.$$

Is the solution in the class  $C^2(0, 1)$ ?

19. Set  $V = \{v \in C[a, b] : \psi_1(x) \leq v(x) \leq \psi_2(x)\}$ , where  $\psi_1$  and  $\psi_2$  are in  $C[a, b]$ ,  $\psi_1(x) \leq \psi_2(x)$  on  $(a, b)$ ,  $\psi_1$  is convex and  $\psi_2$  concave on  $[a, b]$ . Let

$$\delta_h^2 v = \frac{1}{h^2} (v(x+h) - 2v(x) + v(x-h))$$

be the central difference quotient of second order. For fixed  $\zeta \in C_0(a, b)$ ,  $0 \leq \zeta \leq 1$ , define

$$v_\epsilon = v + \epsilon \zeta \delta_h^2 v,$$

where  $\epsilon$  is a positive constant. We suppose that  $h$  is a sufficiently small positive constant such that  $v_\epsilon$  is defined on  $[a, b]$ .

Show that  $v_\epsilon \in V$ , provided that  $0 \leq \epsilon \leq h^2/2$  is satisfied.

*Remark.* Such type of admissible comparison functions were used by Frehse [17] to prove regularity properties of solutions of elliptic variational inequalities.

20. Consider the example "positive solutions of eigenvalue equations" of Section 3.2.8. Show that  $u \leq 0$  on  $(a, b)$  if  $u \in K^*$ .

*Hint:* If  $u \in K^*$ , then  $u \in H_0^1(a, b)$  and

$$\int_a^b (pu'v' + quv) dx \leq 0 \quad \text{for all } v \in K.$$

Inserting  $v(x) = \max\{u(x), 0\}$ .

21. Consider the example "Positive solutions of eigenvalue equations" of Section 3.2.8. Show that a nonnegative eigenfunction is positive on  $(a, b)$ .

Prove the related result for the eigenvalue problem  $-\Delta u = \lambda u$  in  $\Omega$ ,  $u = 0$  on  $\partial\Omega$ . Here is  $\Omega \in \mathbb{R}^n$  a bounded and sufficiently regular domain.

### 3.3 Sufficient conditions; weak minimizers

#### 3.3.1 Free problems

Consider again the problem  $\min_{v \in V} E(v)$ , where

$$E(v) = \int_a^b f(x, v(x), v'(x)) \, dx$$

and  $V = \{v \in C^1[a, b] : v(a) = u_a, v(b) = u_b\}$ . The next theorem shows that an extremal  $u$  is a strict weak local minimizer if the assumptions of Theorem 3.2.9 are satisfied. In contrast to the  $n$  dimensional case, the assumption  $\langle E''(u)\phi, \phi \rangle > 0$  for all  $\phi \in (V - V) \setminus \{0\}$  alone is not sufficient such that  $u$  is a weak local minimizer. A counterexample is, see [53],

$$f = (x - a)^2 y'^2 + (y - a) y'^3, \quad a < x < b.$$

The second variation admits the

$$\langle E''(u)\phi, \phi \rangle = a(u)(\phi, \phi) - b(u)(\phi, \phi),$$

where

$$\begin{aligned} a(u)(\phi, \phi) &= \int_a^b R\phi'^2 \, dx, \\ b(u)(\phi, \phi) &= - \int_a^b (2Q\phi\phi' + P\phi^2) \, dx. \end{aligned}$$

If  $u \in C^2[a, b]$ , then

$$\int_a^b (2Q\phi\phi' + P\phi^2) \, dx = \int_a^b S\phi^2 \, dx,$$

with

$$S = P - \frac{d}{dx}Q.$$

If the strict Legendre condition is satisfied on  $[a, b]$ , then  $u \in C^2[a, b]$  and the quadratic form  $a(u)(\phi, \phi)$  is equivalent to a norm on  $H = H_0^1(a, b)$  and  $b(u)(\phi, \phi)$  is a completely continuous form on  $H$ .

**Theorem 3.3.1.** *Suppose that*

- (i)  $u \in V$  is a solution of the weak Euler equation,
- (ii)  $\langle E''(u)\phi, \phi \rangle > 0$  for all  $\phi \in (V - V) \setminus \{0\}$ ,

(iii)  $f_{u'u'}(x, u(x), u'(x)) > 0$  on  $[a, b]$ .

Then  $u$  is a strict weak local minimizer of  $E$  in  $V$ .

*Proof.* Assumption (ii) implies that  $\langle E''(u)\phi, \phi \rangle \geq 0$  for all  $\phi \in H_0^1(a, b)$ . If  $u$  is no strict local minimizer, then we will show that there is a  $\phi_0 \in H_0^1(a, b)$ ,  $\phi_0 \neq 0$  such that  $\langle E''(u)\phi_0, \phi_0 \rangle = 0$ . Thus  $\phi_0$  is a solution of Jacobi equation  $\langle E''(u)\phi_0, \psi \rangle = 0$  for all  $\psi \in H_0^1(a, b)$ . A regularity argument, we omit the proof here since this problem is addressed in another course, shows that  $\phi \in V - V$ . The idea of proof is a purely variational argument. We insert for  $\psi$  the admissible function  $\zeta(x)\psi^{-h}(x)$ , where  $\zeta$  is a sufficiently regular cut off function and  $\psi^{-h}$  is the backward difference quotient. After some calculation one can show that  $\phi_0 \in H^2(a, b)$  which implies that  $\phi_0 \in C^1[a, b]$ . Set  $B = C^1[a, b]$  and  $H = H_0^1(a, b)$ . If  $u$  is no strict local minimizer, then there is a sequence  $u_n \rightarrow u$  in  $B$ ,  $u_n \neq u$  in  $B$ , such that

$$\begin{aligned} E(u) &\geq E(u_n) = E(u + (u_n - u)) \\ &= E(u) + \langle E'(u), u_n - u \rangle \\ &\quad + \frac{1}{2} \langle E''(u)(u_n - u), u_n - u \rangle + \eta(\|u_n - u\|_B) \|u_n - u\|_H^2. \end{aligned}$$

Then we can write the above inequality as

$$\begin{aligned} 0 &\geq a(u)(u_n - u, u_n - u) - b(u)(u_n - u, u_n - u) \\ &\quad + \eta(\|u_n - u\|_B) \|u_n - u\|_H^2. \end{aligned}$$

Set  $t_n = (a(u)(u_n - u, u_n - u))^{-1/2}$  and  $w_n = t_n(u_n - u)$ . Then

$$\begin{aligned} 0 &\geq a(u)(w_n, w_n) - b(u)(w_n, w_n) \\ &\quad + \eta(\|u_n - u\|_B) \|w_n\|_H^2. \end{aligned}$$

Since  $a(u)(w_n, w_n) = 1$  it follows for a subsequence  $w_n \rightarrow w$  that  $b(u)(w, w) \geq 1$ , in particular  $w \neq 0$ , and  $a(u)(w, w) \leq 1$  since  $a(u)(v, v)$  is lower semicontinuous on  $H$ . It follows  $a(u)(w, w) - b(u)(w, w) \leq 0$ . Since by assumption  $a(u)(v, v) - b(u)(v, v) \geq 0$  for all  $v \in H$  it follows that  $\langle E''(u)w, w \rangle = 0$ .  $\square$

There is an interesting relationship between  $\langle E''(u)\phi, \phi \rangle > 0$  for all  $\phi \in (V - V) \setminus \{0\}$  and an associated eigenvalue problem. Again, we suppose that the strict Legendre condition  $f_{u'u'}(x, u(x), u'(x)) > 0$  on  $[a, b]$  is satisfied. Set  $H = H_0^1(a, b)$  and consider the eigenvalue problem

$$w \in H \setminus \{0\} : a(u)(w, \psi) = \lambda b(u)(w, \psi) \text{ for all } \psi \in H. \quad (3.19)$$

**Lemma.** *Suppose that there is a  $w \in H$  such that  $b(u)(w, w) > 0$ . Then there exists at least one positive eigenvalue of (3.19), and the lowest positive eigenvalue  $\lambda_1^+$  is given by*

$$(\lambda_1^+)^{-1} = \max_{v \in H \setminus \{0\}} \frac{b(u)(v, v)}{a(u)(v, v)}.$$

*Proof.* The idea of proof is taken from Beckert [2]. Set

$$V = \{v \in H : a(u)(v, v) \leq 1\},$$

and consider the maximum problem

$$\max_{v \in V} b(u)(v, v).$$

There is a solution  $v_1$  which satisfies  $a(u)(v_1, v_1) \leq 1$ . From the assumption we see that  $a(u)(v_1, v_1) = 1$ . Then

$$\max_{v \in V} b(u)(v, v) = \max_{v \in V_1} b(u)(v, v),$$

where  $V_1 = \{v \in H : a(u)(v, v) = 1\}$ . The assertion of the lemma follows since for all  $v \in H \setminus \{0\}$  we have

$$\frac{b(u)(v, v)}{a(u)(v, v)} = \frac{b(u)(sv, sv)}{a(u)(sv, sv)},$$

where  $s = (a(u)(v, v))^{-1/2}$ . □

**Theorem 3.3.2.** *The second variation*

$$\langle E''(u)\phi, \phi \rangle = a(u)(\phi, \phi) - b(u)(\phi, \phi)$$

*is positive for all  $\phi \in H \setminus \{0\}$  if and only if there is no positive eigenvalue of (3.19) or if the lowest positive eigenvalue satisfies  $\lambda_1^+ > 1$ .*

*Proof.* (i) Suppose that the second variation is positive, then

$$\frac{b(u)(v, v)}{a(u)(v, v)} < 1$$

for all  $v \in H \setminus \{0\}$ . If  $b(u)(v, v) \leq 0$  for all  $H$ , then there is no positive eigenvalue of (3.19). Assume  $b(u)(v, v) > 0$  for a  $w \in H$ , then we obtain from the above lemma that the lowest positive eigenvalue satisfies  $\lambda_1^+ > 1$ .

(ii) Suppose that there is no positive eigenvalue or that the lowest positive eigenvalue satisfies  $\lambda_1^+ > 1$ .

(iia) Consider the subcase that  $b(u)(v, v) \leq 0$  for all  $v \in H$ , then

$$a(u)(v, v) - b(u)(v, v) \geq 0$$

for all  $v \in H$ . It follows that

$$a(u)(v, v) - b(u)(v, v) > 0$$

for all  $v \in H \setminus \{0\}$ . If not, then we have for a  $w \in H \setminus \{0\}$  that  $a(u)(w, w) = b(u)(w, w)$ . Thus  $a(u)(w, w) \leq 0$ , which implies that  $w = 0$ .

(iib) Suppose that there is a  $w \in H$  such that  $b(u)(w, w) > 0$ . Then there is at least one positive eigenvalue and the lowest positive eigenvalue satisfies, see the lemma above,

$$(\lambda_1^+)^{-1} \geq \frac{b(u)(v, v)}{a(u)(v, v)}$$

for all  $v \in H \setminus \{0\}$ . According to the assumption there is a positive  $\epsilon$  such that

$$1 - \epsilon = (\lambda_1^+)^{-1}.$$

It follows that

$$a(u)(v, v) - b(u)(v, v) \geq \epsilon a(u)(v, v)$$

for all  $v \in H$ . □

**Remark.** In general, the lowest positive eigenvalue  $\lambda_1^+$  is not known explicitly. Thus, the above theorem leads to an important problem in the calculus of variations: *find lower bounds of  $\lambda_1^+$* .

### 3.3.2 Equality constraints

Suppose that  $E : B \mapsto \mathbb{R}$  and  $g_i : B \mapsto \mathbb{R}$ ,  $i = 1, \dots, m$ , and for  $u, h \in B$

$$\begin{aligned} E(u+h) &= E(u) + \langle E'(u), h \rangle + \frac{1}{2} \langle E''(u)h, h \rangle + \eta(\|h\|_B) \|h\|_H^2, \\ g_i(u+h) &= g_i(u) + \langle g_i'(u), h \rangle + \frac{1}{2} \langle g_i''(u)h, h \rangle + \eta(\|h\|_B) \|h\|_H^2, \end{aligned}$$

where  $\lim_{t \rightarrow 0} \eta(t) = 0$ ,  $\langle E'(u), h \rangle$ ,  $\langle g_i'(u), h \rangle$  are bounded linear functionals on  $B$  which admit an extensions to bounded linear functionals on  $H$ . We



suppose that  $\langle E''(u)v, h \rangle$  and  $\langle g'_i(u)v, h \rangle$  are bilinear forms on  $B \times B$  which has continuous extensions to symmetric, bounded bilinear forms on  $H \times H$ .

EXAMPLE:  $B = C^1[a, b]$ ,  $H = H^1(a, b)$  and  $E(v) = \int_a^b (v'(x))^2 dx$ , then

$$E(u + h) = E(u) + \int_a^b u'(x)h'(x) dx + \frac{1}{2} \int_a^b h'(x)h'(x) dx.$$

Set for  $(v, \lambda) \in B \times \mathbb{R}^m$

$$\begin{aligned} L(v, \lambda) &= E(v) + \sum_{j=1}^m \lambda_j g_j(v) \\ L'(v, \lambda) &= E'(v) + \sum_{j=1}^m \lambda_j g'_j(v) \\ L''(v, \lambda) &= E''(v) + \sum_{j=1}^m \lambda_j g''_j(v). \end{aligned}$$

Let

$$V = \{v \in B : g_i(v) = 0, i = 1, \dots, m\}$$

and assume

$$\langle L''(u, \lambda^0)h, h \rangle = a(u, \lambda^0)(h, h) - b(u, \lambda^0)(h, h),$$

where  $a(u, \lambda^0)(v, h)$  and  $b(u, \lambda^0)(v, h)$  are bounded bilinear symmetric forms on  $H \times H$ ,  $a(u, \lambda^0)(v, v)$  is nonnegative on  $H$  and

- (a)  $(a(u, \lambda^0)(v, v))^{1/2}$  is equivalent to a norm on  $H$ ,
- (b)  $b(u, \lambda^0)(v, h)$  is a completely continuous form on  $H \times H$ .

**Theorem 3.3.3.** *Suppose that  $(u, \lambda^0) \in V \times \mathbb{R}^m$  satisfies  $L'(u, \lambda^0) = 0$  and*

$$a(u, \lambda^0)(h, h) - b(u, \lambda^0)(h, h) > 0$$

*for all  $h \in H \setminus \{0\}$  satisfying  $\langle g'_j(u), h \rangle = 0$  for every  $j = 1, \dots, m$ . Then  $u$  is a strict weak local minimizer of  $E$  in  $V$ .*

*Proof.* The proof is close to the proof of Theorem 3.3.1. If  $u$  is no strict local weak minimizer, then there exists a sequence  $u_n \in V$ ,  $\|u_n - u\|_B \neq 0$ ,  $u_n \rightarrow u$  in  $B$  such that

$$\begin{aligned} 0 &\geq E(u_n) - E(u) = L(u_n, \lambda^0) - L(u, \lambda^0) \\ &= \langle L'(u, \lambda^0), u_n - u \rangle + \frac{1}{2} \langle L''(u, \lambda^0)(u_n - u), u_n - u \rangle \\ &\quad + \eta(\|u_n - u\|_B) \|u_n - u\|_H^2 \\ &= \frac{1}{2} a(u, \lambda^0)(u_n - u, u_n - u) - \frac{1}{2} b(u, \lambda^0)(u_n - u, u_n - u) \\ &\quad + \eta(\|u_n - u\|_B) \|u_n - u\|_H^2. \end{aligned}$$

Set

$$t_n = (a(u, \lambda^0)(u_n - u, u_n - u))^{-1/2}$$

and  $w_n = t_n(u_n - u)$ . Then

$$0 \geq 1 - b(u, \lambda^0)(w_n, w_n) + 2\eta(\|u_n - u\|_B) \|w_n\|_H^2.$$

Let  $w_n \rightarrow w$  in  $H$  for a subsequence, then

$$0 \geq 1 - b(u, \lambda^0)(w, w)$$

and

$$a(u, \lambda^0)(w, w) \leq 1.$$

Summarizing, we arrive at

$$a(u, \lambda^0)(w, w) - b(u, \lambda^0)(w, w) \leq 0$$

for a  $w \neq 0$  satisfying

$$\langle g'_j(u), w \rangle = 0, \quad j = 1, \dots, m.$$

The previous equations follow from the above expansion of  $g_j(u + h)$ .  $\square$

There is a related result to Theorem 3.3.2 for constraint problems considered here. Set

$$W = \{h \in H : \langle g'_j(u), h \rangle = 0, \quad j = 1, \dots, m\}$$

and consider the eigenvalue problem

$$w \in W \setminus \{0\} : \quad a(u, \lambda^0)(w, \psi) = \lambda b(u, \lambda^0)(w, \psi) \quad \text{for all } \psi \in W. \quad (3.20)$$

**Theorem 3.3.4.** *Suppose that  $(u, \lambda^0) \in V \times \mathbb{R}^m$  satisfies  $L'(u, \lambda^0) = 0$ . Then  $u$  defines a strict local weak minimizer of  $E$  in  $V$  if there is no positive eigenvalue of (3.20) or if the lowest positive eigenvalue satisfies  $\lambda_1^+ > 1$ .*

*Proof.* Exercise.

### 3.3.3 Unilateral constraints

Assume  $E : B \mapsto \mathbb{R}$ . Let  $V \subset B$  be a nonempty subset and suppose that  $u \in V$  is a weak local minimizer of  $E$  in  $V$ , then

$$\langle E'(u), w \rangle \geq 0 \quad \text{for all } w \in T(V, u),$$

see Theorem 3.2.1. For the definition of  $T(V, u)$  see Section 3.1. We recall that we always suppose that  $u$  is not isolated in  $V$ .

For given  $u \in B$  we assume

$$E(u+h) = E(u) + \langle E'(u), h \rangle + \frac{1}{2} \langle E''(u)h, h \rangle + \eta(\|h\|_B) \|h\|_H^2,$$

where  $\langle E'(u), h \rangle$  is a bounded linear functional on  $B$  which admits an extension to a bounded linear functional on  $H$ , and  $\langle E''(u)v, h \rangle$  is a bilinear form on  $B \times B$  which has a continuous extensions to a symmetric, bounded bilinear form on  $H \times H$ . Moreover, we suppose that

$$\langle E''(u)h, h \rangle = a(u)(h, h) - b(u)(h, h),$$

where  $a(u)(v, h)$  and  $b(u)(v, h)$  are bounded bilinear symmetric forms on  $H \times H$ ,  $a(u)(v, v)$  is nonnegative on  $H$  and

- (i)  $(a(u)(v, v))^{1/2}$  is equivalent to a norm on  $H$ ,
- (ii)  $b(u)(v, h)$  is a completely continuous form on  $H \times H$ .

**Definition.** Let  $T_{E'}(V, u)$  be the set of all  $w \in T(V, u)$  such that, if  $u_n$  and  $t_n = \|u_n - u\|_H^{-1}$  are associated sequences to  $w$ , then

$$\limsup_{n \rightarrow \infty} t_n^2 \langle E'(u), u_n - u \rangle < \infty.$$

**Corollary.** *If  $u \in V$  satisfies the necessary condition  $\langle E'(u), w \rangle \geq 0$  for all  $w \in T(V, u)$ , then  $\langle E'(u), w \rangle = 0$  for all  $w \in T_{E'}(V, u)$ .*

*Proof.* Exercise.

**Theorem 3.3.5.** *Suppose that  $u \in V$  satisfies the necessary condition of Theorem 3.2.1 and that*

$$\liminf_{n \rightarrow \infty} t_n^2 \langle E'(u), u_n - u \rangle \geq 0$$

*for all associated sequences  $u_n, t_n$  to  $w \in T_{E'}(V, u)$ . Then  $u$  is a strict weak local minimizer of  $E$  in  $V$  if  $T_{E'}(V, u) = \{0\}$  or if*

$$a(u)(w, w) - b(u)(w, w) > 0 \quad \text{for all } w \in T_{E'}(V, u) \setminus \{0\}.$$

*Proof.* If  $u$  is no strict local weak minimizer of  $E$  in  $V$ , then there exists a sequence  $u_n \in V$  satisfying  $\|u_n - u\|_B \neq 0$ ,  $u_n \rightarrow u$  in  $B$ , such that

$$\begin{aligned} E(u) &\geq E(u + u_n - u) \\ &= E(u) + \langle E'(u), u_n - u \rangle \\ &\quad + \frac{1}{2}[(a(u)(u_n - u, u_n - u) - b(u)(u_n - u, u_n - u)] \\ &\quad + \eta(\|u_n - u\|_B)\|u_n - u\|_H^2. \end{aligned}$$

Set

$$t_n = (a(u)(u_n - u, u_n - u))^{-1/2}$$

and  $w_n = t_n(u_n - u)$ . Then

$$0 \geq t_n \langle E'(u), w_n \rangle + \frac{1}{2}[1 - b(u)(w_n, w_n)] + \eta(\|u_n - u\|_B)\|w_n\|_H^2, \quad (3.21)$$

which implies that

$$\limsup_{n \rightarrow \infty} t_n^2 \langle E'(u), u_n - u \rangle < \infty.$$

It follows, if  $w_0$  is a weak limit of a subsequence  $w_{n'}$  of  $w_n$ , that  $w_0 \in T_{E'}(V, u)$ , and inequality (3.21) yields

$$0 \geq \liminf_{n \rightarrow \infty} \langle E'(u), t_{n'} w_{n'} \rangle + \frac{1}{2}[1 - b(u)(w_0, w_0)].$$

Since the first term on the right hand side is nonnegative by assumption, we get

$$0 \geq 1 - b(u)(w_0, w_0),$$

which implies that  $w_0 \neq 0$ . Since the square of the norm on a real Hilbert space defines a weakly lower semicontinuous functional, we have

$$a(u)(w_0, w_0) \leq 1.$$

Combining the two previous inequalities, we obtain finally that

$$a(u)(w_0, w_0) - b(u)(w_0, w_0) \leq 1 - b(u)(w_0, w_0) \leq 0,$$

which is a contradiction to the assumptions of the theorem.  $\square$

**Remark.** Assumption

$$\liminf_{n \rightarrow \infty} t_n^2 \langle E'(u), u_n - u \rangle \geq 0$$

is satisfied if  $V$  is convex since  $\langle E'(u), v - u \rangle \geq 0$  for all  $v \in V$ .

**Corollary.** *A  $u \in V$  satisfying the necessary condition is a strict weak local minimizer of  $E$  in  $V$  if*

$$\sup b(u)(v, v) < 1,$$

where the supremum is taken for all  $v \in T_{E'}(V, u)$  satisfying  $a(u)(v, v) \leq 1$ .

*Proof.* Inequality  $a(u)(v, v) - b(u)(v, v) > 0$  for  $v \in T_{E'}(V, u)$  is equivalent to  $1 - b(u)(v, v) > 0$  for  $v \in T_{E'}(V, u)$  satisfying  $a(u)(v, v) = 1$ . We recall that  $T_{E'}(V, u)$  is a cone with vertex at zero.  $\square$

It follows immediately

**Corollary.** *Let  $K$  be a closed cone with vertex at zero satisfying  $T_{E'}(V, u) \subset K$ . Suppose that  $u \in V$  satisfies the necessary condition. Then  $u$  is a strict weak local minimizer of  $E$  in  $V$  if*

$$\mu := \max b(u)(v, v) < 1,$$

where the maximum is taken over  $v \in K$  satisfying  $a(u)(v, v) \leq 1$ .

**Remark.** If  $K$  is convex and if there exists a  $w \in K$  such that  $b(u)(w, w) > 0$ , then  $\mu^{-1}$  is the lowest positive eigenvalue of the variational inequality, see [37],

$$w \in K : \quad a(u)(w, v - w) \geq \lambda b(u)(w, v - w) \quad \text{for all } v \in K.$$

**Example: Stability of a unilateral beam**

Consider the example "A unilateral problem for the beam" of Section 3.2.8, see Figure 3.13. Set

$$V = \{v \in H_0^1(0, l) \cap H^2(0, l) : v(x) \leq d \text{ on } (0, l)\},$$

$$\begin{aligned} a(u, v) &= \int_0^l u''(x)v''(x) dx \\ b(u, v) &= \int_0^l u'(x)v'(x) dx \end{aligned}$$

and

$$E(v, \lambda) = \frac{1}{2}a(v, v) - \frac{\lambda}{2}b(v, v),$$

where  $u, v \in V$  and  $\lambda = P/(EI)$ . The family of functions

$$u = u(k; x) = \begin{cases} \frac{d}{\pi} \left( \sqrt{\lambda}x + \sin(\sqrt{\lambda}x) \right) & : 0 \leq x < k \\ d & : k \leq x \leq l - k \\ \frac{d}{\pi} \left( \sqrt{\lambda}(1 - x) + \sin(\sqrt{\lambda}(1 - x)) \right) & : l - k \leq x < l \end{cases}$$

where  $0 < k \leq l/2$  and  $\lambda = (\pi/k)^2$  defines solutions of the variational inequality

$$u \in V : \langle E'(u, \lambda), v - u \rangle \geq 0 \quad \text{for all } v \in V,$$

where  $\lambda = (\pi/k)^2$ .

**Proposition.** *Suppose that  $l/4 < k \leq l/2$ , then  $u = u(k; x)$  is a strict local minimizer of  $E$  in  $V$ , i. e., there is a  $\rho > 0$  such that  $E(u, \lambda) < E(v, \lambda)$  for all  $v \in V$  satisfying  $0 < \|u - v\|_{H^2(0, l)} < \rho$ , and  $u$  is no local minimizer if  $k < l/4$ .*

*Proof.* The cone  $T_{E'}(V, u)$  is a subset of the linear space

$$L(k) = \{v \in H_0^1(0, l) \cap H^2(0, l) : v(k) = v(l - k) = 0, v'(k) = v'(l - k) = 0\},$$

see the following lemma. We show, see Theorem 3.3.5 and the second Corollary, that  $a(v, v) - \lambda b(v, v) > 0$  for all  $v \in L(k) \setminus \{0\}$  if  $l/4 < k \leq l/2$ . We recall that  $\lambda = (\pi/k)^2$ . Consider the eigenvalue problem

$$w \in L(k) : a(w, v) = \mu b(w, v) \quad \text{for all } v \in L(k). \quad (3.22)$$

In fact, this problem splits into three problems if  $0 < k < l/2$ . The first one is to find the lowest eigenvalue of a compressed beam of length  $l - 2k$  which is clamped at both ends, and the other two consist in finding the lowest eigenvalue of the compressed beam of length  $k$  which is simply supported at one end and clamped at the other end. Thus the lowest eigenvalue  $\mu_1$  of (3.22) is

$$\mu_1 = \min \left\{ \left( \frac{\tau_1}{k} \right)^2, \left( \frac{2\pi}{l - 2k} \right)^2 \right\},$$

where  $\tau_1 = 4.4934\dots$  is the lowest positive zero of  $\tan x = x$ . Then  $u$  is a strict weak local minimizer if

$$\lambda = \left( \frac{\pi}{k} \right)^2 < \mu_1$$

is satisfied. This inequality is satisfied if and only if  $l/4 < k \leq l/2$ .

If  $0 < k < l/4$ , then  $u(k; x)$  is no local minimizer since  $E(u+w; \lambda) < E(u; \lambda)$ , where  $w(x)$ ,  $k \leq x \leq l-k$ , is the negative eigenfunction to the first eigenvalue of the compressed beam of length  $l - 2k$  which is clamped at both ends  $x = k$  and  $x = l - k$ . On  $0 \leq x \leq k$  and on  $l - k \leq x \leq l$  we set  $w(x) = 0$ .  $\square$

It remains to show

**Lemma.** *The cone  $T_{E'}(V, u)$  is a subset of the linear space*

$$L(k) = \{v \in H_0^1(0, l) \cap H^2(0, l) : v(k) = v(l - k) = 0, v'(l) = v'(l - k) = 0\}.$$

*Proof.* Let  $w \in T_{E'}(V, u)$ , i. e., there is a sequence  $u_n \in V$ ,  $u_n \rightarrow u$  in  $H$  such that  $t_n(u_n - u) \rightarrow w$ , where  $t_n = \|u_n - u\|_H^{-1}$  and

$$\limsup_{n \rightarrow \infty} t_n^2 \langle E'(u, \lambda), u_n - u \rangle < \infty.$$

We have

$$w_n(k) \leq 0 \quad \text{and} \quad w_n(l - k) \leq 0,$$

where  $w_n = t_n(u_n - u)$ , and

$$\langle E'(u, \lambda), w_n \rangle = -A_1 w_n(k) - A_2 w_n(l - k), \quad (3.23)$$

with

$$A_1 = u'''(k - 1), \quad A_2 = u'''(l - k + 0)$$

are positive constants. From the definition of  $T_{E'}(V, u)$  it follows that

$$\langle E'(u, \lambda), w_n \rangle \leq c_1 t_n^{-1}.$$

By  $c_i$  we denote positive constants. Set

$$\epsilon_n = t_n^{-1} \equiv \|u_n - u\|_H,$$

then

$$-A_1 w_n(k) - A_2 w_n(l-k) \leq c_1 \epsilon_n. \quad (3.24)$$

It follows that  $w_n(k), w_n(l-k) \rightarrow 0$  as  $n \rightarrow \infty$ , which implies

$$w(k) = 0 \quad \text{and} \quad w(l-k) = 0.$$

Now we prove that

$$w'(k) = 0 \quad \text{and} \quad w'(l-k) = 0.$$

We have  $u + \epsilon_n w_n = u_n$ , that is  $u + \epsilon_n w_n \leq d$  on  $[0, l]$ , or

$$\epsilon_n w_n \leq d - u \quad \text{on} \quad [0, l]. \quad (3.25)$$

Since  $u \in H^3(0, l)$ , which follows directly by calculation or from a general regularity result due to Frehse [17], and  $w_n \in H^2(0, l)$ , we have the Taylor expansions<sup>3</sup>

$$\begin{aligned} w_n(k+h) &= w_n(k) + w'_n(k)h + O(|h|^{3/2}), \\ u(k+h) &= u(k) + u'(k)h + \frac{1}{2}u''(k)h^2 + O(|h|^{5/2}) \\ &= d + O(|h|^{5/2}) \end{aligned}$$

---

<sup>3</sup>Let  $x \pm h \in (0, l)$  and  $v \in H^m(0, l)$ . Then

$$v(x+h) = v(x) + v'(x)h + \dots + \frac{1}{(m-1)!}v^{(m-1)}(x)h^{m-1} + R_m,$$

where

$$R_m = \frac{1}{(m-1)!} \int_0^h (h-t)^{m-1} v^{(m)}(x+t) dt$$

which satisfies

$$|R_m| \leq c \|v^{(m)}\|_{H^m(0,l)} |h|^{\frac{2m-1}{2}}.$$



since  $u'(k) = u''(k) = 0$ . Then we obtain from (3.25) that

$$\epsilon_n \left( w_n(k) + w'_n(k)h - c_2|h|^{3/2} \right) \leq c_3|h|^{5/2}. \quad (3.26)$$

We consider two cases.

*Case 1.* Suppose that  $w_n(k) = 0$  for a subsequence, then we get from (3.26) that  $w'_n(k) = 0$  for this sequence, which implies  $w'(k) = 0$ .

*Case 2.* Suppose that  $w_n(k) < 0$  for all  $n > n_0$ . Set

$$\alpha_n = -w_n(k), \quad \beta_n = |w'_n(k)|.$$

From above we have that  $\alpha_n \rightarrow 0$  as  $n \rightarrow \infty$ . Assume  $\beta_n \geq \beta$  with a positive constant  $\beta$ . Set

$$h = \frac{2\alpha_n}{\beta} \text{sign}(w'_n(k)),$$

then we obtain from inequality (3.26) that

$$\epsilon_n \left( -\alpha_n + 2\alpha_n \frac{\beta_n}{\beta} - c_2 \left( \frac{2\alpha_n}{\beta} \right)^{3/2} \right) \leq c_3 \left( \frac{2\alpha_n}{\beta} \right)^{5/2},$$

which implies

$$\epsilon_n \left( \alpha_n - c_2 \left( \frac{2\alpha_n}{\beta} \right)^{3/2} \right) \leq c_3 \left( \frac{2\alpha_n}{\beta} \right)^{5/2}.$$

Consequently

$$\epsilon_n \leq c_4 \alpha_n^{3/2} \quad (3.27)$$

for all  $n \geq n_0$ ,  $n_0$  sufficiently large. Combining this inequality with inequality (3.24), we find

$$A_1 \alpha_n \leq c_1 c_4 \alpha_n^{3/2}$$

which is a contradiction to  $A_1 > 0$ . Consequently  $w'_n(k) \rightarrow 0$ . Thus  $w'(k) = 0$ . We repeat the above consideration at  $x = l - k$  and obtain that  $w'(l - k) = 0$ .  $\square$

## 3.3.4 Exercises

1. Show that the square of the norm on a Hilbert space defines a weakly lower semicontinuous functional.
2. Set  $B = C^1[a, b]$ ,  $H = H^1(a, b)$  and

$$E(v) = \int_a^b f(x, v(x), v'(x)) dx,$$

where  $v \in B$ , and  $f$  is assumed to be sufficiently regular. Show, if  $u, h \in B$ , then

$$E(u+h) = E(u) + \langle E'(u), h \rangle + \frac{1}{2} \langle E''(u)h, h \rangle + \eta(\|h\|_B) \|h\|_H^2,$$

where

$$\begin{aligned} \langle E'(u), h \rangle &= \int_a^b [f_u(x, u, u')h + f_{u'}(x, u, u')h'] dx \\ \langle E''(u)h, h \rangle &= \int_a^b [f_{uu}(x, u, u')h^2 + 2f_{uu'}(x, u, u')hh' \\ &\quad + f_{u'u'}(x, u, u')h'^2] dx, \end{aligned}$$

and  $\lim_{t \rightarrow 0} \eta(t) = 0$ .

*Hint:* Set  $g(\epsilon) = \int_a^b f(x, u + \epsilon h, u' + \epsilon h') dx$ . Then

$$g(1) = g(0) + g'(0) + \frac{1}{2}g''(0) + \frac{1}{2}[g''(\delta) - g''(0)],$$

where  $0 < \delta < 1$ .

3. Set

$$a(u)(h, h) = \int_a^b f_{u'u'}(x, u, u')h'(x)^2 dx,$$

where  $u, h \in C^1[a, b]$ . Show that  $(a(u)(h, h))^{1/2}$  is equivalent to a norm on  $H_0^1(a, b)$ , provided that the strict Legendre condition

$$f_{u'u'}(x, u(x), u'(x)) > 0$$

is satisfied on  $[a, b]$ .

*Hint:* Show that there exists a positive constant  $c$  such that

$$\int_a^b h'(x)^2 dx \geq c \int_a^b h(x)^2 dx$$

for all  $h \in C_0^1(a, b)$ .

4. Show that the bilinear form defined on  $H \times H$ , where  $H = H^1(a, b)$ ,

$$b(u)(\phi, \psi) = - \int_a^b [f_{uu'}(\phi\psi' + \phi'\psi) + f_{uu}\phi\psi] dx,$$

where  $f_{uu'}$ ,  $f_{uu} \in C[a, b]$ , is completely continuous on  $H \times H$ , i. e.,

$$\lim_{n, l \rightarrow \infty} b(u)(\phi_n, \psi_l) = b(u)(\phi, \psi)$$

if  $\phi_n \rightarrow \phi$  and  $\psi_l \rightarrow \psi$  in  $H$ .

*Hint:* (i) The sequences  $\{\phi_n\}$ ,  $\{\psi_l\}$  are bounded in  $H^1(a, b)$ .

(ii) The sequences  $\{\phi_n\}$ ,  $\{\psi_l\}$  are equicontinuous sequences.

(iii) Use the Arzela-Ascoli Theorem.

5. Prove Theorem 3.3.4.

### 3.4 Sufficient condition; strong minimizers

The following consideration concerns a class of free problems. There are related results for isoperimetric problems, see [6, 52, 19], for example. Set

$$V = \{v \in C^1[a, b] : v(a) = u_a, v(b) = u_b\}$$

and for  $v \in V$

$$E(v) = \int_a^b f(x, v(x), v'(x)) dx,$$

where  $f(x, y, p)$  is a given and sufficiently regular function  $f : [a, b] \times \mathbb{R} \times \mathbb{R} \mapsto \mathbb{R}$ .

We recall that  $u \in V$  is called a *weak* local minimizer of  $E$  in  $V$  if there exists a  $\rho > 0$  such that  $E(u) \leq E(v)$  for all  $v \in V$  satisfying  $\|v - u\|_{C^1[a, b]} < \rho$ . And  $u \in V$  is said to be a *strong* local minimizer of  $E$  in  $V$  if there exists a  $\rho > 0$  such that  $E(u) \leq E(v)$  for all  $v \in V$  satisfying  $\|v - u\|_{C[a, b]} < \rho$ .

Let  $u \in V$  be a weak solution of the Euler equation, that is

$$u \in V : \langle E'(u), \phi \rangle = 0 \text{ for all } \phi \in V - V.$$

If the strict Legendre condition is satisfied on  $[a, b]$ , then  $u \in C^2[a, b]$ , i. e.,  $u$  is a solution of the Euler equation. Assume

$$\langle E''(u)\phi, \phi \rangle > 0 \text{ for all } \phi \in (V - V) \setminus \{0\},$$

then  $u$  is a weak local minimizer of  $E$  in  $V$ , see Theorem 3.3.1. If additionally  $f_{pp}(x, y, p) \geq 0$  for all  $(x, y) \in D_\delta(u)$  and  $p \in \mathbb{R}$ , where for a  $\delta > 0$

$$D_\delta(u) = \{(x, y) : a \leq x \leq b, u(x) - \delta \leq y \leq u(x) + \delta\},$$

then we will prove that  $u$  is a strong local minimizer of  $E$  in  $V$ .

**Definition.** A set  $D \subset \mathbb{R}^2$  is said to be *simply covered* by a family of curves defined by  $y = g(x, c)$ ,  $c \in (c_1, c_2)$ , if each point  $(x, y) \in D$  is contained in exactly one of these curves. Such a family is called a *foliation* of  $D$ . If a given curve defined by  $y = u(x)$  is contained in this family, that is  $u(x) = g(x, c_0)$ ,  $c_1 < c_0 < c_2$ , then  $u$  is called *embedded* in this family.

**Lemma 3.4.1** (Existence of an embedding family). *Let  $u \in V \cap C^2[a, b]$  be a solution of the Euler equation. Suppose that the strict Legendre condition  $f_{pp}(x, u(x), u'(x)) > 0$  is satisfied on  $[a, b]$  and that the second variation*

$\langle E''(u)\phi, \phi \rangle$  is positive on  $(V - V) \setminus \{0\}$ . Then there exists a foliation  $v(\mu)$ ,  $|\mu| < \epsilon$ , of  $D_\delta(u)$ , provided  $\delta$  and  $\epsilon$  are sufficiently small. Every element of this foliation solves the Euler equation, and  $v(0) = u$ .

*Proof.* Consider the family of boundary value problems

$$\frac{d}{dx} f_{v'}(x, v, v') = f_v(x, v, v') \quad \text{on } (a, b) \quad (3.28)$$

$$v(a) = u_a + \mu \quad (3.29)$$

$$v(b) = u_b + \mu, \quad (3.30)$$

where  $\mu$  is a constant,  $\mu \in (-\epsilon, \epsilon)$ ,  $\epsilon > 0$ . Define the mapping

$$M(v, \mu) : C^2[a, b] \times (-\epsilon, \epsilon) \mapsto C[a, b] \times \mathbb{R} \times \mathbb{R}$$

by

$$M(v, \mu) = \begin{pmatrix} -\frac{d}{dx} f_{v'}(x, v, v') + f_v(x, v, v') \\ v(a) - u_a - \mu \\ v(b) - u_b - \mu \end{pmatrix}.$$

We seek a solution  $v(\mu)$  of  $M(v, \mu) = 0$ . Since  $M(v(0), 0) = 0$ , where  $v(0) = u$ , and  $M_v(u, 0)$  defined by

$$M_v(u, 0)h = \begin{pmatrix} -\frac{d}{dx}(Rh')' + Sh \\ h(a) \\ h(b) \end{pmatrix}$$

is a regular mapping from  $C^2[a, b] \mapsto C[a, b] \times \mathbb{R} \times \mathbb{R}$ , it follows from an implicit function theorem, see [28], for example, that there exists a unique solution

$$v(x, \mu) = u + \mu v_1(x) + r(x, \mu) \quad (3.31)$$

of (3.28), (3.29), (3.29), where  $r \in C^1([a, b] \times (-\epsilon, \epsilon))$ ,  $r(x, \mu) = o(\mu)$ ,  $\lim_{\mu \rightarrow 0} r_\mu(x, \mu) = 0$ , uniformly on  $[a, b]$ , and  $v_1$  is the solution of the Jacobi boundary value problem.

$$\begin{aligned} -\frac{d}{dx}[R(x, u, u') v'] + S(x, u, u') v &= 0 \quad \text{on } (a, b) \\ v(a) &= 1 \\ v(b) &= 1. \end{aligned}$$

The solution  $v_1$  is positive on  $[a, b]$ . To show this, we set  $\zeta(x) = \max\{-v_1(x), 0\}$ , then

$$\begin{aligned} 0 &= \int_a^b [-(Rv')'\zeta + Sv\zeta] dx \\ &= \int_a^b (Rv'\zeta' + Sv\zeta) dx \\ &= - \int_{\{-v_1(x) > 0\}} (R\zeta'^2 + S\zeta^2) dx \\ &= - \int_a^b (R\zeta'^2 + S\zeta^2) dx. \end{aligned}$$

It follows that  $\zeta = 0$ , i. e.,  $v_1(x) \geq 0$  on  $[a, b]$ . Assume there is a zero  $x_0 \in (a, b)$  of  $v_1(x)$ , then  $v'(x_0) = 0$ . Consequently  $v(x) \equiv 0$  on  $[a, b]$ , which contradicts the boundary conditions.

Finally, for given  $(x, y) \in D_\delta(u)$ ,  $\delta > 0$  sufficiently small, there exists a unique solution  $\mu = \mu(x, y)$  of  $v(x, \mu) - y = 0$  since  $v_\mu(x, 0) = v_1(x) > 0$  on  $[a, b]$ .  $\square$

Let  $v(x, \mu)$  be the solution of (3.28)–(3.31). Set  $F(x, \mu) = v'(x, \mu)$ . From the previous lemma we have that for given  $(x, y) \in D_\delta(u)$  there exists a unique  $\mu = \mu(x, y)$  which defines the curve of the foliation which contains  $(x, y)$ . Set

$$\Phi(x, y) = F(x, \mu(x, y)),$$

and consider the vector field  $\mathcal{A} = (Q, -P)$ , where

$$\begin{aligned} P(x, y) &= f(x, y, \Phi(x, y)) - \Phi(x, y)f_p(x, y, \Phi(x, y)) \\ Q(x, y) &= f_p(x, y, \Phi(x, y)). \end{aligned}$$

**Lemma 3.4.2** (Hilbert's invariant integral). *Suppose that  $C_v$  is a curve in  $D_\delta(u)$  defined by  $y = v(x)$ ,  $v \in C^1[a, b]$ ,  $v(a) = u_a$  and  $v(b) = u_b$ . Then, the integral*

$$U(v) = \int_{C_v} P(x, y)dx + Q(x, y)dy,$$

*is independent of  $v$ .*

*Proof.* We show that  $P_y = Q_x$  in  $\Omega$ . This follows by a straightforward calculation. We have

$$\begin{aligned} P_y &= f_y + f_p\Phi_y - \Phi_y f_p - \Phi(f_{py} + f_{pp}\Phi_y) \\ Q_x &= f_{px} + f_{pp}\Phi_x. \end{aligned}$$

Thus

$$P_y - Q_x = f_y - \Phi(f_{py} + f_{pp}\Phi_y) - f_{px} - f_{pp}\Phi_x.$$

The right hand side is zero in  $D_\delta(u)$ . To show this, let  $(x_0, y_0) \in D_\delta(u)$  be given, and consider the curve of the foliation defined by

$$\begin{aligned} y'(x) &= \Phi(x, y(x)) \\ y(x_0) &= y_0 \end{aligned}$$

We recall that

$$\begin{aligned} \Phi(x, y) &= F(x, c(x, y)) \\ &\equiv F(x, c(x, y(x))) \\ &\equiv \Phi(x, y(x)), \end{aligned}$$

if  $y(x)$  defines a curve of the foliation, since  $c(x, y) = \text{const.}$  along this curve.

Then

$$\begin{aligned} y'(x_0) &= \Phi(x_0, y_0) \\ y''(x_0) &= \Phi_x(x_0, y_0) + \Phi_y(x_0, y_0)y'(x_0) \\ &= \Phi_x(x_0, y_0) + \Phi_y(x_0, y_0)\Phi(x_0, y_0). \end{aligned}$$

Inserting  $y'(x_0)$  and  $y''(x_0)$  from above into the Euler equation, which is satisfied along every curve of the foliation,

$$f_y - f_{px} - f_{py}y' - f_{pp}y'' = 0,$$

we obtain that  $P_y - Q_x = 0$  at  $(x_0, y_0) \in D_\delta(u)$ .  $\square$

On the weak local minimizer  $u$  in consideration we have

$$E(u) = U(u) \tag{3.32}$$

since

$$\begin{aligned} U(u) &= \int_a^b [f(x, u(x), \Phi(x, u(x))) - \Phi(x, u(x))f_p(x, u(x), \phi(x, u(x))) \\ &\quad + f_p(x, u(x), u'(x))u'(x)] dx \\ &= \int_a^b f(x, u(x), u'(x)) dx. \end{aligned}$$

We recall that  $u'(x) = \Phi(x, u(x))$ .

**Definition.** The function

$$\mathcal{E}(x, y, p, q) = f(x, y, q) - f(x, y, p) + (p - q)f_p(x, y, p)$$

is called *Weierstrass excess function*.

**Corollary.** Suppose that  $f_{pp}(x, y, p) \geq 0$  for all  $(x, y) \in D_\delta(u)$  and for all  $p \in \mathbb{R}$ , then  $\mathcal{E} \geq 0$  in  $D_\delta(u) \times \mathbb{R} \times \mathbb{R}$ .

**Theorem 3.4.1.** Let  $u \in V$  be a solution of the weak Euler equation, that is of  $\langle E'(u), \phi \rangle = 0$  for all  $\phi \in V - V$ . Suppose that

(i)  $f_{pp}(x, u(x), u'(x)) > 0$  on  $[a, b]$ ,

(ii)  $\langle E''(u)\phi, \phi \rangle > 0$  for all  $\phi \in (V - V) \setminus \{0\}$ ,

(iii)  $\mathcal{E}(x, y, p, q) \geq 0$  for all  $(x, y) \in D_\delta(u)$  and for all  $p, q \in \mathbb{R}$ .

Then  $u$  is a strong local minimizer of  $E$  in  $V$ .

*Proof.* Let  $v \in V \cap D_\delta(u)$ . From equation (3.32) and Lemma 3.4.2 we see that

$$\begin{aligned} E(v) - E(u) &= E(v) - U(u) \\ &= E(v) - U(v) \\ &= \int_a^b [f(x, v, v') - f(x, v, \Phi(x, v)) \\ &\quad + (\Phi(x, v) - v')f_p(x, v, \Phi(x, v))] dx \\ &= \int_a^b \mathcal{E}(x, v(x), \Phi(x, v), v') dx \\ &\geq 0. \end{aligned}$$

□

EXAMPLE: Set  $V = \{v \in C^1[0, l] : v(0) = 0, v(l) = 1\}$  and for  $v \in V$

$$E(v) = \int_0^l [(v'(x))^2 - (v(x))^2] dx.$$

The solution of the Euler equation is  $u = \sin x / \sin l$ , provided  $l \neq k\pi$ ,  $k = \pm 1, \pm 2, \dots$ . Assumption (iii) of the above theorem is satisfied since  $\mathcal{E}(x, y, p, q) = (p - q)^2$ , and assumption (ii), that is  $\int_0^l (\phi'^2 - \phi^2) dx > 0$  for all  $\phi \in (V - V) \setminus \{0\}$  holds if the lowest eigenvalue  $\lambda_1 = (\pi/l)^2$  of  $-\phi'' = \lambda\phi$  on  $(0, l)$ ,  $\phi(0) = \phi(l) = 0$  satisfies  $\lambda_1 > 1$ , see Theorem 3.3.2. Thus  $u$  is a strong local minimizer of  $E$  in  $V$  if  $0 < l < \pi$ .

In fact,  $u$  is a strong global minimizer of  $E$  in  $V$  if  $0 < l < \pi$ , see an exercise.



**3.4.1 Exercises**

1. Suppose that  $\int_a^b (R\phi'^2 + S\phi^2) dx > 0$  for all  $\phi \in (V - V) \setminus \{0\}$ . Show that there exists a unique solution of the Jacobi boundary value problem

$$\begin{aligned} -\frac{d}{dx}[R(x, u, u') v'] + S(x, u, u') v &= g(x) \text{ on } (a, b) \\ v(a) &= v_a \\ v(b) &= v_b, \end{aligned}$$

where  $g \in C[a, b]$  and  $v_a, v_b \in \mathbb{R}$  are given.

2. Show that the solution  $u$  of the example defines a global strong minimizer of  $E$  in  $V$ .

### 3.5 Optimal control

For a given function  $v(t) \in U \subset \mathbb{R}^m$ ,  $t_0 \leq t \leq t_1$ , we consider the boundary value problem

$$y'(t) = f(t, y(t), v(t)), \quad y(t_0) = x^0, \quad y(t_1) = x^1, \quad (3.33)$$

where  $y \in \mathbb{R}^n$ ,  $x^0$  and  $x^1$  are given, and

$$f : [t_0, t_1] \times \mathbb{R}^n \times \mathbb{R}^m \mapsto \mathbb{R}^n.$$

In general, there is no solution of such a problem. Therefore we consider the set of admissible controls  $U_{ad}$  defined by the set of piecewise continuous functions  $v$  on  $[t_0, t_1]$  such that there exists a continuous and piecewise continuously differentiable solution of the boundary value problem. Such a solution is continuously differentiable at all regular points of the control  $v$ . A point  $t \in (t_0, t_1)$  where  $v(t)$  is continuous is called a *regular point* of the control  $v$ . We suppose that this set is not empty. Assume a cost functional is given by

$$E(v) = \int_{t_0}^{t_1} f^0(t, y(t), v(t)) dt,$$

where

$$f^0 : [t_0, t_1] \times \mathbb{R}^n \times \mathbb{R}^m \mapsto \mathbb{R},$$

$v \in U_{ad}$  and  $y(t)$  is the solution of the above boundary value problem with the control  $v$ .

The functions  $f$ ,  $f^0$  are assumed to be continuous in  $(t, y, v)$  and continuously differentiable in  $(t, y)$ . *It is not required that these functions are differentiable with respect to  $v$ .*

Then the problem of optimal control is

$$\max_{v \in U_{ad}} E(v). \quad (3.34)$$

A piecewise continuous solution  $u$  is called *optimal control* and the continuous and piecewise continuously differentiable solution  $x$  of the associated system of boundary value problems is said to be an *optimal trajectory*.

### 3.5.1 Pontryagin's maximum principle

The governing necessary condition for this type of problems is the following maximum principle, see Pontryagin et al. [48]. Set

$$H(t, y, v, p_0, p) = p_0 f^0(t, y, v) + \langle p, f(t, y, v) \rangle,$$

where  $p_0 \in \mathbb{R}$  and  $p \in \mathbb{R}^n$ . This function  $H$  is called *Hamilton function* associated to the above optimal control problem.

**Theorem 3.5.1** (Pontryagin's maximum principle). *Let  $u(t)$  be a piecewise continuous solution of the maximum problem, and let  $x(t)$  be the associated continuous and piecewise continuously differentiable trajectory. Then there exists a constant  $p_0$  and a continuous and piecewise continuously differentiable vector function  $p(t)$ , not both are zero, such that*

(i)  $p(t)$  is a solution of the linear system

$$p'(t) = -H_x(t, x(t), u(t), p_0, p(t)), \quad (3.35)$$

in all regular points.

(ii) In all regular points  $t$  of the optimal control  $u(t)$  we have

$$H(t, x(t), u(t), p_0, p(t)) \geq H(t, x(t), v, p_0, p(t)) \quad \text{for all } v \in U.$$

(iii)  $p_0 = 1$  or  $p_0 = 0$ .

**Definition.** The vector function  $p(t)$  is called *adjoint function*.

**Remarks.** (i) In the case that we do not prescribe the endpoint  $x^1$ , which is called the free endpoint case, then we have to add in (i) the additional endpoint condition  $p(t_1) = 0$ . For this case of a free endpoint there is an elementary proof of the Pontryagin maximum principle, see below.

(ii) If the endpoint condition is  $y(t_1) \geq x^1$ , then  $p(t_1) \geq 0$ , and if the optimal trajectory satisfies  $x(t_1) > 0$ , then  $p(t_1) = 0$ .

### 3.5.2 Examples

Example: **Consumption versus investment**

This example was taken from [55], pp. 78. Suppose that the admissible set of controls is  $V = [0, 1]$ , the cost functional is given by

$$E(v) = \int_0^T U(1 - v(t)) dt,$$

and the differential equation and the boundary conditions which defines the trajectory  $y : [0, T] \mapsto \mathbb{R}$  are

$$y'(t) = v(t), \quad y(0) = x_0, \quad y(T) \geq x_1.$$

We suppose additionally that

$$x_0 < x_1 < x_0 + T. \quad (3.36)$$

For the utility function  $U(s)$ ,  $0 \leq s < \infty$ , we assume  $U \in C^2$ ,  $U' > 0$  and  $U'' < 0$ .

*Economic interpretation:*  $x(t)$  level of infrastructure at time  $t$ ,  
 $u(t)$  level of investment in infrastructure at  $t$ ,  
 $1 - u(t)$  level of consumption at  $t$ ,  
 $[0, T]$  planning period.

The Hamilton function is here

$$H = p_0 U(1 - v) + pv,$$

then equation (3.35) is given by

$$p'(t) = -H_x.$$

Since  $H$  does not depend on  $y$  we find that  $p(t) = c = \text{const.}$  and  $c \geq 0$ , see the second remark above. Thus, if  $u(t)$  is an optimal control then we have in regular points  $t$  the inequality

$$H = p_0 U(1 - u(t)) + cu(t) \geq p_0 U(1 - v) + cv \quad \text{for all } v \in [0, 1]. \quad (3.37)$$

We recall that the nonnegative constants  $p_0$  and  $c$  are not simultaneously zero. Since  $H_{uu} = p_0 U''(1 - u)$ , where  $p_0 \geq 0$  and  $U'' < 0$ , we find from the maximum property (3.37) three cases:

- (i)  $u = 0$  is a maximizer of  $H$ , then  $H_u \leq 0$  at  $u = 0$ ,
- (ii)  $u = a$ , where  $a$ ,  $0 < a < 1$ , is a constant maximizes  $H$ , then  $H_u = 0$  at  $u = a$ ,

(iii)  $u = 1$  is a maximizer of  $H$ , then  $H_u \geq 0$  at  $u = 1$ . Since  $H_u = -p_0U'(1 - u) + c$ , we have for regular  $t$ : if

$$u(t) = 0, \text{ then } c \leq p_0U'(1), \quad (3.38)$$

$$0 < u(t) < 1, \text{ then } p_0U'(1 - u(t)) = c, \quad (3.39)$$

$$u(t) = 1, \text{ then } p_0U'(0) \leq c. \quad (3.40)$$

We show that  $p_0 = 1$ . If not, then  $p_0 = 0$ . Then  $u = 1$  is a maximizer of  $H$  for all  $t$ . It follows from the differential equation  $x'(t) = u(t) \equiv 1$  that  $x(t) = t + x_0$ , thus  $x(T) = T + x_0$ . The assumption (3.36) implies that the optimal trajectory satisfies  $x(T) > x_1$ . This case is covered by Section 3.5.3 (free endpoint) below. In this case we have  $c = p(T) = 0$ . Since  $p_0 = 1$ , the Hamilton function  $H = U(1 - v) + cv$  is strictly concave, which implies that there exists a unique maximizer of  $H$  in  $[0, 1]$  which does not depend of  $t$  since  $H$  is independently of  $t$ . Then the optimal control is  $u(t) = u^* = \text{const.}$ ,  $u^* \in [0, 1]$ .

We have  $u^* > 0$ . If not, then we get from  $x'(t) = u(t)$ ,  $x(0) = x_0$ , that  $x(T) = x_0$ , a contradiction to the assumption (3.36).

The inequality  $u^* > 0$  implies that  $c > 0$ , see (3.38)-(3.40). Then  $x(T) = x_1$ . If  $x(T) > x_1$ , then  $p(T) = c = 0$ , see the remark above.

If  $u^* = 1$ , then there is no consumption, which contradicts the side condition (3.36) since in this case  $x(t) = t + x_0$ . Thus  $x(T) = T + x_0$ , a contradiction to  $x(T) \geq x_1$  and  $x_1 < T + x_0$ .

We get finally that  $u^* \in (0, 1)$ , which implies that  $x(t) = x_0 + u^*t$ . Thus we have

$$u(t) = u^* = \frac{x_1 - x_0}{T}$$

since  $x(T) = x_1$ , and the associated optimal trajectory is given by

$$x(t) = x_0 + \frac{x_1 - x_0}{T}t.$$

#### Example: Workers versus capitalists

This example was taken from [55], pp. 222. Suppose that we have two admissible sets of controls  $u(t) \in U = [a, b]$ ,  $0 < a < b < 1$ , and  $v(t) \in V = [0, 1]$ , and two cost functionals  $W$  and  $C$  given by

$$W(u, v) = \int_0^T u(t)K(t) dt,$$

$$C(u, v) = \int_0^T (1 - v(t))(1 - u(t))K(t) dt.$$

and the differential equation and the boundary conditions which define the trajectory  $K(t) : [0, T] \mapsto \mathbb{R}$  are

$$K'(t) = v(t)(1 - u(t))K(t), \quad K(0) = K_0 > 0, \quad K(T) \text{ free.}$$

That is, no assumption on the final state is posed. We suppose additionally that

$$T > \frac{1}{b} \quad \text{and} \quad T > \frac{1}{1-b}.$$

*Economic interpretation:*  $K(t)$  capital stock of the firm. Rate of production is proportional to  $K$ ,

$u(t)K(t)$  share of profit of the workers,

$(1 - u(t))K(t)$  profit of the firm,

$v(t)(1 - u(t))K(t)$  is investment of the company and the rest  $(1 - v(t))(1 - u(t))K(t)$  remains for consumption of the firm.

We are looking for a *Nash equilibrium*, that is, for piecewise continuous controls  $u^*(t) \in U$ ,  $v^*(t) \in V$  such that

$$\begin{aligned} W(u^*, v^*) &\geq W(u, v^*) \quad \text{for all } u \in U \\ C(u^*, v^*) &\geq C(u^*, v) \quad \text{for all } v \in V. \end{aligned}$$

Suppose there exists a Nash equilibrium, then the associated Hamilton functions are given by, if  $p_0 = 1$ :

$$\begin{aligned} H_W &= uK + pv^*(t)(1 - u)K \\ H_C &= (1 - v)(1 - u^*(t))K + qv(1 - u^*(t))K, \end{aligned}$$

where  $p$  and  $q$  are the associate adjoint functions.

A discussion similar to the previous example leads to the following result, exercise or [55], pp 224,

*Case  $b \geq 1/2$ .* Set  $t' = T - 1/(1 - b)$ , then

$$\begin{aligned} u^*(t) &= a, \quad v^*(t) = 1 \quad \text{if } t \in [0, t'], \\ u^*(t) &= b, \quad v^*(t) = 0 \quad \text{if } t \in (t', T]. \end{aligned}$$

*Case  $b < 1/2$ .* Set

$$t' = T - \frac{1}{1-b}, \quad t'' = t' - \frac{1}{1-b} \ln \left( \frac{1}{2b} \right),$$

then

$$\begin{aligned}u^*(t) &= a \text{ if } t \in [0, t''], u^*(t) = b \text{ if } t \in (t'', T], \\v^*(t) &= 1 \text{ if } t \in [0, t'], v^*(t) = 0 \text{ if } t \in (t', T].\end{aligned}$$

### 3.5.3 Proof of Pontryagin's maximum principle; free endpoint

Here we prove Theorem 3.5.1, where  $p_0 := 1$ , and the boundary conditions in (3.33) are replaced by  $y(t_0) = x^0$ , *no condition* at  $t_1$ . The proof is close to a proof given in [24].

Let  $u(t)$  be an optimal control and let  $\tau \in (t_0, t_1)$  be a regular point. We define a new admissible control  $u_\epsilon(t)$ , see Figure 3.14 by a *needle variation*

$$u_\epsilon(t) = \begin{cases} u(t) & : t \notin [\tau - \epsilon, \tau] \\ v & : t \in [\tau - \epsilon, \tau] \end{cases},$$

where  $\epsilon > 0$  is sufficiently small and  $v \in U$ . Let  $x_\epsilon(t)$ , see Figure 3.15, be

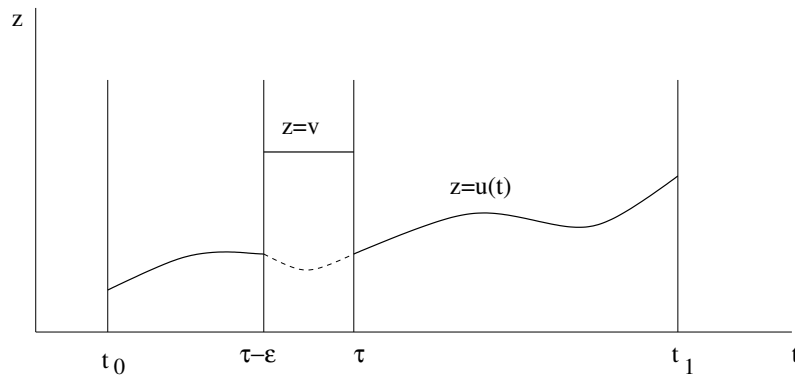

Figure 3.14: Needle variation

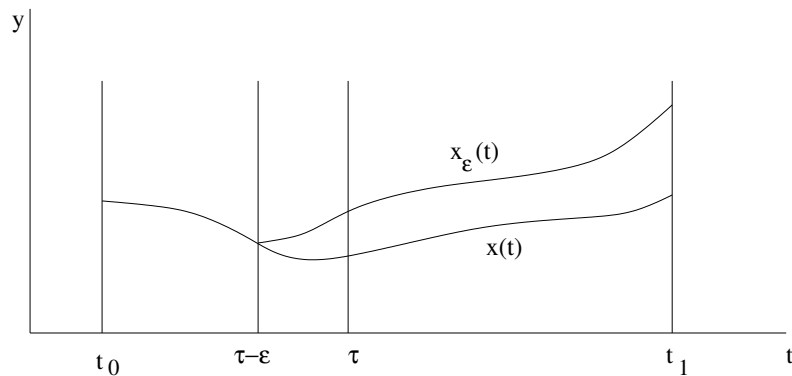

Figure 3.15: Variation of the trajectory



the perturbed trajectory associated to  $u_\epsilon(t)$  defined by

$$x_\epsilon(t) = \begin{cases} x(t) & : t_0 < t < \tau - \epsilon \\ x^*(t) & : \tau - \epsilon < t < t_1 \end{cases},$$

where  $x^*$  denotes the solution of the initial value problem

$$\begin{aligned} y'(t) &= f(t, y(t), u_\epsilon(t)) \quad \tau - \epsilon < t < t_1, \\ y(\tau - \epsilon) &= x(\tau - \epsilon). \end{aligned}$$

Since

$$\begin{aligned} x_\epsilon(\tau - \epsilon) - x_\epsilon(\tau) &= -x'_\epsilon(\tau)\epsilon + o(\epsilon) \\ x(\tau - \epsilon) - x(\tau) &= -x'(\tau)\epsilon + o(\epsilon) \end{aligned}$$

as  $\epsilon \rightarrow 0$ , it follows that

$$\begin{aligned} x_\epsilon(\tau) &= x(\tau) + \epsilon[x'_\epsilon(\tau) - x'(\tau)] + o(\epsilon) \\ &= x(\tau) + \epsilon[f(\tau, x_\epsilon(\tau), v) - f(\tau, x(\tau), u(\tau))] + o(\epsilon) \\ &= x(\tau) + \epsilon[f(\tau, x(\tau), v) - f(\tau, x(\tau), u(\tau))] + o(\epsilon). \end{aligned}$$

The previous equation is a consequence of  $x_\epsilon(\tau) = x(\tau) + O(\epsilon)$ . We recall that  $\tau$  is a regular point. Set

$$w(\tau, v) = f(\tau, x(\tau), v) - f(\tau, x(\tau), u(\tau)),$$

then the changed trajectory  $x_\epsilon(t)$  on  $\tau < t < t_1$  is given by, see an exercise,

$$x_\epsilon(t) = x(t) + \epsilon\Theta(t, \tau)w(\tau, v) + o(\epsilon),$$

where  $\Theta(t, \tau)$  is the fundamental matrix associated to the linear system

$$w'(t) = f_x(t, x(t), u(t)) w(t),$$

where

$$f_x = \begin{pmatrix} f_{x_1}^1 & \cdots & f_{x_n}^1 \\ \cdots & \cdots & \cdots \\ f_{x_1}^n & \cdots & f_{x_n}^n \end{pmatrix}.$$

We recall that  $\Theta(t, t) = I$ ,  $I$  the identity matrix, and  $w(t) = \Theta(t, \tau) a$  is the solution of the initial value problem  $w'(t) = f_x w(t)$ ,  $w(\tau) = a$ . We have

$$\begin{aligned}
E(u_\epsilon) - E(u) &= \int_{\tau-\epsilon}^{\tau} [f^0(t, x_\epsilon(t), v) - f^0(t, x(t), u(t))] dt \\
&\quad + \int_{\tau}^{t_1} [f^0(t, x_\epsilon(t), u(t)) - f^0(t, x(t), u(t))] dt \\
&= \epsilon [f^0(t^*, x_\epsilon(t^*), v) - f^0(t^*, x(t^*), u(t^*))] \\
&\quad + \int_{\tau}^{t_1} \left( \langle f_x^0(t, x(t), u(t)), x_\epsilon(t) - x(t) \rangle \right. \\
&\quad \left. + o(|x_\epsilon(t) - x(t)|) \right) dt \\
&= \epsilon [f^0(t^*, x_\epsilon(t^*), v) - f^0(t^*, x(t^*), u(t^*))] \\
&\quad + \epsilon \int_{\tau}^{t_1} \langle f_x^0(t, x(t), u(t)), y(t) \rangle dt + o(\epsilon),
\end{aligned}$$

where  $t^* \in [\tau - \epsilon, \tau]$  and  $y(t) := \Theta(t, \tau)w(\tau, v)$ .

From the assumption  $E(u_\epsilon) \leq E(u)$ ,  $\epsilon > 0$ , it follows

$$\lim_{\epsilon \rightarrow 0} \frac{E(u_\epsilon) - E(u)}{\epsilon} \leq 0.$$

Combining this inequality with the previous expansion of  $E(u_\epsilon) - E(u)$ , we obtain

$$f^0(\tau, x(\tau), v) - f^0(\tau, x(\tau), u(\tau)) + \int_{\tau}^{t_1} \langle f_x^0(t, x(t), u(t)), y(t) \rangle dt \leq 0$$

for every regular  $\tau \in (t_0, t_1)$ . Then the theorem follows from the formula

$$\int_{\tau}^{t_1} \langle f_x^0(t, x(t), u(t)), y(t) \rangle dt = \langle f(\tau, x(\tau), u(\tau)), p(\tau) \rangle - \langle f(\tau, x(\tau), v), p(\tau) \rangle, \quad (3.41)$$

where  $p(t)$  is the solution of the initial value problem

$$p'(t) = -f_x^T p - f_x^0, \quad p(t_1) = 0.$$

Formula (3.41) is a consequence of

$$\begin{aligned}
\frac{d}{dt} \langle p(t), y(t) \rangle &= \langle p'(t), y(t) \rangle + \langle p(t), y'(t) \rangle \\
&= -\langle f_x^T p, y \rangle - \langle f_x^0, y \rangle + \langle p, f_{xy} \rangle \\
&= -\langle f_x^0, y \rangle.
\end{aligned}$$

### 3.5.4 Proof of Pontryagin's maximum principle; fixed endpoint

Here we will prove Theorem 3.5.1, see [48], pp. 84. The following proof is close to [48] and to [3], where an important part of the proof (see Case (ii) below) is sketched. See also [59] for a sketch of the proof. We will give an easy proof of Pontryagin's maximum principle. See also [21], pp. 75, for a proof, based on Brouwer's fixed point theorem.

The idea is to use more than one needle variation of the given optimal control in order to achieve the fixed target  $x^1$  with a perturbed trajectory. At first, we transform problem (3.34) into an autonomous problem of Mayer's type, i. e., we maximize a single coordinate of a new trajectory vector. Define the first new coordinate by the initial value problem

$$y'_{n+1}(t) = 1, \quad y_{n+1}(t_0) = t_0,$$

which implies that  $y_{n+1}(t) = t$ . The second new coordinate is defined by

$$y'_0(t) = f^0(y_{n+1}(t), y(t), v(t)), \quad y_0(t_0) = 0.$$

Then the maximum problem (3.34) is equivalent to

$$\max_{v \in U_{ad}} y_0(t_1, v), \quad (3.42)$$

where  $y_0(t) \equiv y_0(t, v)$ . Set

$$Y = (y_0, y_1, \dots, y_n, y_{n+1}), \quad F = (f^0, f^1, \dots, f^n, 1),$$

then the new trajectory satisfies the differential equation

$$Y' = F(y, y_{n+1}, v) \quad (3.43)$$

and the boundary and initial conditions are

$$y_0(t_0) = 0, \quad y_{n+1}(t_0) = t_0, \quad y(t_0) = x^0, \quad y(t_1) = x^1, \quad (3.44)$$

where  $y = (y_1, \dots, y_n)$ .

Let

$$P = (p_0, p, p_{n+1}), \quad p = (p_1, \dots, p_n).$$

Define the Hamilton function by

$$H(y, y_{n+1}, v, P) = \langle P, F(y, y_{n+1}, v) \rangle.$$

Suppose that  $u$  is an optimal control, i. e., a solution of problem (3.42), and  $X$  is the associated trajectory satisfying

$$X' = F(x, x_{n+1}, u) \equiv H_P(x, x_{n+1}, u), \quad t_0 < t < t_1,$$

where  $x = (x_1, \dots, x_n)$  and  $X = (x_0, x, x_{n+1})$ .

We will show that there is a continuous and piecewise continuously differentiable vector function  $P(t) \neq 0$  which solves

$$P'(t) = -H_X(x, x_{n+1}, u, P), \quad t_0 < t < t_1, \quad (3.45)$$

and at all regular points  $t \in (t_0, t_1)$

$$H(x(t), x_{n+1}(t), u(t), P(t)) \geq H(x(t), x_{n+1}(t), v, P(t)) \quad (3.46)$$

for all  $v \in U$ , and

$$p_0(t) = \text{const.} \geq 0. \quad (3.47)$$

We consider a finite set of needle variations at regular points  $\tau_i$  of the given optimal control  $u(t)$  defined by replacing  $u(t)$  by a constant  $v_i \in U$  on the intervals  $[\tau_i - \epsilon a_i, \tau_i]$ , where  $t_0 < \tau_i < t_1$ ,  $\tau_i$  different from each other,  $a_i > 0$  are fixed and  $\epsilon > 0$  is sufficiently small, see Figure 3.16. Consider the linear

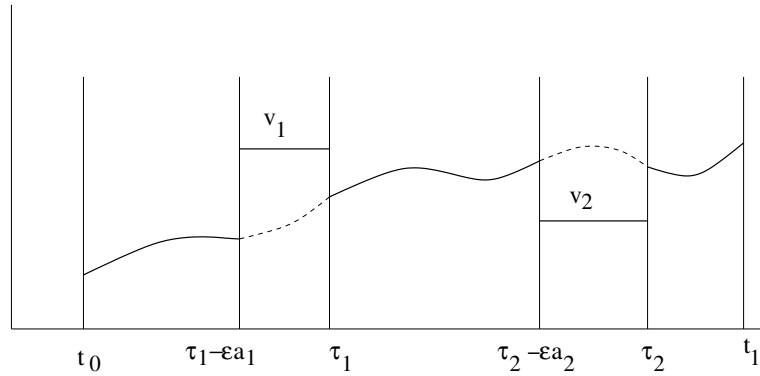

Figure 3.16: Needle variations

system

$$W'(t) = A(t) W(t), \quad (3.48)$$

where

$$A = \begin{pmatrix} f_{x_0}^0 & \cdots & f_{x_{n+1}}^0 \\ \dots\dots\dots\dots\dots\dots \\ f_{x_0}^{n+1} & \cdots & f_{x_{n+1}}^{n+1} \end{pmatrix}.$$

The matrix  $A(t)$  is piecewise continuous on  $(t_0, t_1)$ . As in the previous proof we see that the perturbed trajectory is given by

$$X_\epsilon(t) = X(t) + \epsilon \sum_{i=1}^s a_i \Theta(t, \tau_i) W(\tau_i, v_i) + o(\epsilon), \quad (3.49)$$

where  $\Theta(t, \tau)$  is the fundamental matrix to the system (3.48) and

$$W(\tau_i, v_i) := F(X(\tau_i), v_i) - F(X(\tau_i), u(\tau_i)).$$

Define for an  $s$ -tuple  $z = (\tau_1, \dots, \tau_s)$ ,  $t_0 < \tau_i < t_1$ ,  $\tau_i$  are different from each other, and for  $v = (v_1, \dots, v_s)$ , where  $v_l \in U$ , the set

$$C(z, v) = \{Y \in \mathbb{R}^{n+2} : Y = \sum_{i=1}^s a_i \Theta(t_1, \tau_i) W(\tau_i, v_i), a_i > 0\}.$$

This set is a convex cone with vertex at the origin. Denote by  $Z(s)$  the set of all  $s$ -tuples  $z$  from above and let  $V(s)$  be the set of all  $s$ -tuples  $v$  such that the coordinates are in  $U$ . Define the set

$$\mathcal{C} = \bigcup_{s=1}^{\infty} \bigcup_{z \in Z(s), v \in V(s)} C(z, v).$$

This set is a convex cone in  $\mathbb{R}^{n+2}$  with vertex at the origin, see an exercise.

Consider the ray  $L = r \mathbf{e}_0$ ,  $r > 0$ , where  $\mathbf{e}_0 = (1, 0, \dots, 0) \in \mathbb{R}^{n+2}$ . If  $L$  is not in the interior of  $\mathcal{C}$ , then we will prove the maximum principle by using separation results for convex sets. If  $L$  is in the interior of  $\mathcal{C}$ , then we are lead to a contradiction to the assumption that  $u$  is optimal. In this case we will show by using Brouwer's fixed point theorem that there is an admissible needle variation which produces an associated trajectory  $X_\epsilon(t)$  such that the first coordinate satisfies  $x_{0,\epsilon}(t_1) > x_0(t_1)$ , where  $x_0(t)$  is the first coordinate of the trajectory  $X(t)$  associated to the optimal control  $u(t)$ .

*Case (i).*  $L$  is not in the interior of  $\mathcal{C}$ . From Theorem 2.6.1 and Theorem 2.6.2 it follows, see two of the following exercises, that there exists a vector  $P_1 \in \mathbb{R}^{n+2}$ ,  $P_1 \neq 0$ , such that

$$\langle P_1, y \rangle \leq 0 \quad \text{for all } y \in \mathcal{C} \quad \text{and} \quad \langle P_1, r \mathbf{e}_0 \rangle \geq 0. \quad (3.50)$$

Let  $\Pi$  be the plane defined by, see Figure 3.17,

$$\Pi = \{z \in \mathbb{R}^{n+2} : \langle P_1, z \rangle = 0\}.$$

Consider the initial value problem

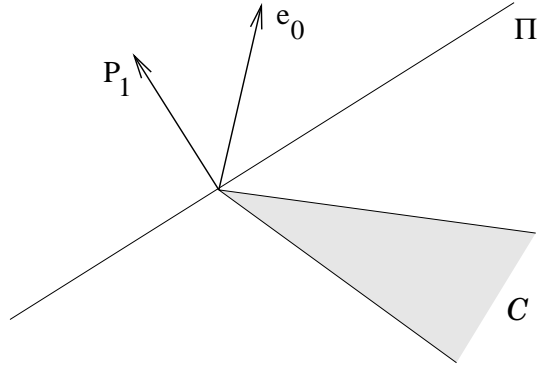

Figure 3.17: Separation of  $\mathcal{C}$  and  $L = re_0$

$$P'(t) = -F_X(x(t), x_{n+1}, u(t)) P(t), \quad P(t_1) = P_1.$$

Let  $\Psi(t, \tau)$  be the fundamental matrix of this system, then

$$P(t) = \Psi(t, t_0) P(t_0), \quad P(t_0) = \Psi^{-1}(t_1, t_0) P(t_1).$$

Let  $t \in (t_0, t_1)$  be a regular point of the optimal control  $u(t)$ . Set

$$W(t, v) = F(x(t), x_{n+1}(t), v) - F(x(t), x_{n+1}(t), u(t)), \quad (3.51)$$

where  $v \in U$ . Then

$$\epsilon \Theta(t_1, t) W(t, v) \in \mathcal{C},$$

where  $\epsilon > 0$ . Then, see (3.50),

$$\langle P(t_1), \Theta(t_1, t) W(t, v) \rangle \leq 0.$$

Since  $\Psi^T(t, \tau) \Theta(t, \tau) = I$ , where  $I$  is the identity matrix, see an exercise, and from  $P(t_1) = \Psi(t_1, t) P(t)$  we obtain

$$\langle P(t), W(t, v) \rangle \leq 0.$$

Consequently, see the definition (3.51) of  $W(t, v)$ ,

$$H(x(t), x_{n+1}(t), u(t), P(t)) \geq H(x(t), x_{n+1}(t), v, P(t))$$

for all  $v \in U$  and for all regular points  $t \in (t_0, t_1)$ .

Finally, from  $H_{x_0} = 0$  it follows that  $p_0(t) = \text{const.}$ , and from the second inequality of (3.50) we get that  $p_0 \geq 0$ . Thus we can assume that  $p_0 = 0$  or  $p_0 = 1$ . This follows since we can replace  $P_1$  by  $P_1/p_0$  in the considerations above if  $p_0 > 0$ .

*Case (ii).* Suppose that  $L$  is in the interior of  $\mathcal{C}$ . Then  $z^0 = r_0 \mathbf{e}_0$ ,  $r_0 > 0$ , is in the interior of  $\mathcal{C}$ , and there are  $n + 2$  linearly independent  $A^i \in \mathcal{C}$  such that  $z^0$  is an interior point of the closed simplex  $\mathcal{S}$  defined by

$$\sum_{i=1}^{n+2} \lambda_i A^i, \quad \lambda_i \geq 0, \quad \sum_{i=1}^{n+2} \lambda_i \leq 1,$$

see Figure 3.18. Let  $\lambda_i(z)$  are the (uniquely determined) barycentric coordinates<sup>4</sup> of  $z \in \mathcal{S}$ , then

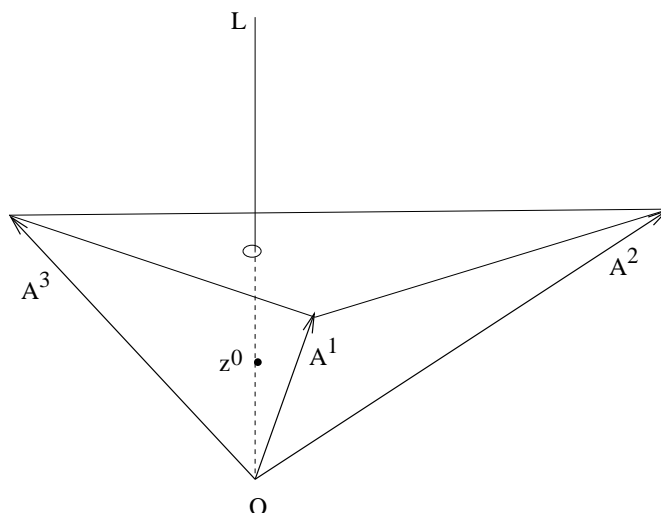

Figure 3.18: Simplex in consideration

dinates<sup>4</sup> of  $z \in \mathcal{S}$ , then

$$z = \sum_{i=1}^{n+2} \lambda_i(z) A^i.$$

<sup>4</sup>In fact, barycentric coordinates  $\lambda_0, \dots, \lambda_m$  of  $z \in \mathbb{R}^m$  are called the real numbers in the representation  $z = \sum_{l=0}^m \lambda_l x^l$ ,  $\sum_{l=0}^m \lambda_l = 1$ , where  $x^0, \dots, x^m \in \mathbb{R}^m$  are given and the  $m$  vectors  $x^l - x^0$ ,  $l = 1, \dots, m$  are linearly independent. The  $m$ -dimensional simplex  $\mathcal{S}$  defined by such vectors is the set of all  $z = \sum_{l=0}^m \lambda_l x^l$ , where  $\lambda_l \geq 0$  and  $\sum_{l=0}^m \lambda_l = 1$ . Thus  $z - x^0 = \sum_{l=1}^m \lambda_l x^l$ , where  $\lambda_l \geq 0$  and  $\sum_{l=1}^m \lambda_l \leq 1$ .

We recall that  $\lambda_i(z)$  are continuous in  $z$ , and  $z$  is in the interior of  $\mathcal{S}$  if and only if  $\lambda_i(z) > 0$  for every  $i$  and  $\sum_{i=1}^{n+2} \lambda_i(z) < 1$ . From the definition of  $\mathcal{C}$  we see that

$$A^i = \sum_{l=1}^{s_i} a_l^i \Theta(t_1, \tau_l^i) W(\tau_l^i, v_l^i).$$

Consider needle variations of the optimal control at  $\tau_l^i$  with associated  $\lambda_i a_l^i$ ,  $v_l^i$ , where  $\tau_l^i$ ,  $a_l^i$  and  $v_l^i$  are fixed, and

$$\sum_{i=1}^{n+2} \lambda_i \leq 1, \quad \lambda_i > 0.$$

Since  $A^i$  are continuous with respect to  $\tau_l^i$ , which are all regular by assumption, we can assume that all  $\tau_l^i$  are different from each other. Then the associated perturbed trajectory at  $t = t_1$  is given by

$$X_\epsilon(t_1) = X(t_1) + \epsilon \sum_{i=1}^{n+2} [\lambda_i + b_i(\lambda, \epsilon)] A^i,$$

where  $b_i(\lambda, \epsilon)$  are continuous in  $\lambda$ , for each fixed  $\epsilon$ ,  $0 < \epsilon \leq \epsilon_0$ ,  $\epsilon_0$  sufficiently small, and  $b_i(\lambda, \epsilon) \rightarrow 0$  as  $\epsilon \rightarrow 0$ , uniformly on  $\{\lambda \in \mathbb{R}^{n+2} : 0 \leq \lambda_i \leq 1, i = 1, \dots, n+2\}$ .

Let  $z$  be in the interior of  $\mathcal{S}$  and let  $\lambda_i(z)$  are the associated barycentric coordinates. Set

$$\begin{aligned} q(z, \epsilon) &= \sum_{i=1}^{n+2} [\lambda_i(z) + b_i(\lambda(z), \epsilon)] A^i \\ &\equiv z + \sum_{i=1}^{n+2} b_i(\lambda(z), \epsilon) A^i, \end{aligned}$$

and consider for fixed  $\epsilon$ ,  $0 < \epsilon \leq \epsilon_0$ , the mapping  $T : \mathcal{S} \mapsto \mathbb{R}^{n+2}$ , defined by

$$T(z, \epsilon) := z - q(z, \epsilon) + z^0.$$

This mapping is continuous in  $z$  and maps the closed ball  $B_\rho(z^0) \subset \mathbb{R}^{n+2}$ , which is in the interior of  $\mathcal{S}$ , into this ball, provided that  $\epsilon_0$  is sufficiently small. Brouwer's fixed point theorem, see [8, 30, 22], says that there is a  $z^* \in B_\rho(z^0)$ ,  $z^* = z^*(\epsilon)$ , such that  $T(z^*, \epsilon) = z^*$ . Set  $\lambda_i = \lambda_i(z^*)$  in the needle variation above, we get finally

$$X_\epsilon(t_1) = X(t_1) + \epsilon r_0 \mathbf{e}_0.$$

□



## 3.5.5 Exercises

1. Consider the "Two sector model", see [55], p. 89. Suppose that the admissible set of controls is  $V = [0, 1]$ , the cost functional is given by

$$E(v) = \int_0^T y_2(t) dt,$$

and the differential equations and the side conditions which define the trajectory  $y : [0, T] \mapsto \mathbb{R}^2$  are

$$\begin{aligned} y_1'(t) &= av(t)y_1(t), & y_1(0) &= y_1^0 \\ y_2'(t) &= a(1-v(t))y_1(t) & y_2(0) &= y_2^0, \end{aligned}$$

where  $a$  is positive constant and the initial data  $y_1^0$  and  $y_2^0$  are given.

2. Consider a model for "Growth that pollutes", see [55], pp. 92. Suppose that the admissible set of controls is  $V = [0, 1]$ , the cost functional is given by

$$E(v) = \int_0^T [(1-v(t))y_1(t) - by_2(t)] dt,$$

$b$  is a positive constant,  $v(t) \in V$  piecewise continuous, and the differential equations and the side conditions which define the trajectory  $y : [0, T] \mapsto \mathbb{R}^2$  are

$$\begin{aligned} y_1'(t) &= v(t)y_1(t), & y_1(0) &= y_1^0, & y_1(T) &\text{free}, \\ y_2'(t) &= y_1(t), & y_2(0) &= y_2^0, & y_2(T) &\leq y_2^T, \end{aligned}$$

where the data  $y_1^0$  and  $y_2^0$  and  $y_2^T$  are given.

3. Consider a model for "Consumption versus investment", see [55], pp. 113. Suppose that the admissible set of controls is  $V = [0, 1]$ , the cost functional is given by

$$E(v) = \int_0^T \left(1 - e^{-(1-v(t))y(t)}\right) dt,$$

where  $v(t) \in V$  is piecewise continuous, and the differential equation and the side conditions which defines the trajectory  $y : [0, T] \mapsto \mathbb{R}$  are

$$y'(t) = v(t) y(t), \quad y(0) = y^0 > 0, \quad y(T) \text{ free}.$$

4. Show that the solution  $x_\epsilon$  of the initial value problem, see the proof of Pontryagin's maximum principle in the case of a free endpoint,

$$\begin{aligned} z'(t) &= f(t, z(t), u(t)), \quad \tau < t < t_1 \\ z(\tau) &= x(\tau) + \epsilon w(\tau, v) + o(\epsilon) \end{aligned}$$

satisfies

$$x_\epsilon(t) = x(t) + \epsilon \Theta(t, \tau) w(\tau, v).$$

*Hint:*  $z := (\partial x_\epsilon / \partial \epsilon)|_{\epsilon=0}$  is the solution of the initial value problem  $z'(t) = f_x z(t)$ ,  $z(\tau) = w(\tau, v)$ .

5. Show that the mapping  $M_v(u, 0)$ , see the proof of Lemma 3.4.1, is regular.
6. Let  $x : [t_0, t_1] \mapsto \mathbb{R}$  be a  $C^1[t_0, t_1]$ -solution of the initial value problem

$$\begin{aligned} x'(t) &= f(t, x(t)) \quad \text{in } (t_0, t_1), \\ x(\tau) &= a, \end{aligned}$$

where  $a$  is given and  $f$  is sufficiently regular with respect to  $(t, x)$ . Show that there exists a solution  $y(t)$  of

$$\begin{aligned} y'(t) &= f(t, y(t)) \quad \text{in } (t_0, t_1), \\ y(\tau) &= a + \mu, \end{aligned}$$

where  $\mu \in (-\mu_0, \mu_0)$ ,  $\mu > 0$  sufficiently small.

*Hint:* Consider the mapping

$$M(y, \mu) : C^1[t_0, t_1] \times \mathbb{R} \mapsto C[t_0, t_1] \times \mathbb{R}$$

defined by

$$M(y, \mu) = \begin{pmatrix} y'(t) - f(t, y(t)) \\ y(\tau) - a - \mu \end{pmatrix},$$

and apply an implicit function theorem, see for example [28].

7. Let  $K \subset \mathbb{R}^n$  be a nonempty convex cone with vertex at the origin and assume  $x \notin \text{cl } K$ . Then there is a  $p \in \mathbb{R}^n \setminus \{0\}$  such that  $\langle p, x \rangle > 0$  and  $\langle p, y \rangle \leq 0$  for all  $y \in \text{cl } K$ .

*Hint:* Apply Theorem 2.6.1.

8. Let  $K \subset \mathbb{R}^n$  be a nonempty convex cone with vertex at the origin, and assume  $x \in \partial K$ . Then there is a  $p \in \mathbb{R}^n \setminus \{0\}$  such that  $\langle p, x \rangle \geq 0$  and  $\langle p, y \rangle \leq 0$  for all  $y \in K$ .

*Hint:* Theorem 2.6.2 says that there are  $p \in \mathbb{R}^n \setminus \{0\}$  and  $\alpha \in \mathbb{R}$  such that  $\langle p, x \rangle = \alpha$  and  $\langle p, y \rangle \leq \alpha$  for all  $y \in \text{cl } K$ .

9. Show that the set  $\mathcal{C}$  defined in Section 3.5.4 is a convex cone with vertex at the origin.
10. Let  $A(t)$  be a continuous  $N \times N$ -matrix,  $t_0 < t < t_1$ . Consider the initial value problems  $w'(t) = A(t)w(t)$ ,  $w(\tau) = w_0$  and  $v'(t) = -A^T(t)v(t)$ ,  $v(\tau) = v_0$ , where  $\tau \in (t_0, t_1)$ . Denote by  $\Theta(t, \tau)$  and  $\Psi(t, \tau)$  the associated fundamental matrix, respectively. Show that  $\psi^T(t, \tau)\Theta(t, \tau) = I$ , where  $I$  denotes the identity matrix.

*Hint:* If  $t = \tau$ , then  $\Theta(\tau, \tau) = \Psi(\tau, \tau) = I$ . Let  $\xi \in \mathbb{R}^N$ , set  $y(t) = \Psi^T(t, \tau)\Theta(t, \tau)\xi$  and show that  $y'(t) = 0$ . Thus  $\xi = \Psi^T(t, \tau)\Theta(t, \tau)\xi$  for all  $\xi \in \mathbb{R}^N$ .

11. Define the fundamental matrix for the linear system  $Y'(t) = A(t)Y(t)$ , where  $A(t)$  is a *piecewise continuous* quadratic matrix.
12. See [29], pp. 10. Let  $K \subset \mathbb{R}^n$  be compact and convex and let  $F : K \mapsto K$  be continuous. Show that  $F$  admits a fixed point by assuming that there is a fixed point if  $K$  is a ball  $\Sigma$  or an  $n$ -dimensional simplex  $\Sigma$ .

*Hint:* Consider for  $x \in \Sigma$  the mapping  $F(p_K(x))$ , where  $p_K$  is the orthogonal projection onto  $K$ .



# Bibliography

- [1] R. A. Adams, *Sobolev Spaces*. Academic Press, New York, 1975.
- [2] H. Beckert, *Über eine bemerkenswerte Klasse gemischtfreier Variationsprobleme höherer Ordnung*. Math. Zeitschr. **103** (1968), 18–29.
- [3] B. Beavis and I. M. Dobbs, *Optimization and Stability Theory for Economic Analysis*. Cambridge University Press 1990.
- [4] S. Bernstein, *Sur un théorème de géométrie et son application aux dérivées partielles du type elliptique*. Comm. Soc. Math. de Kharkov (2)**15**,(1915–1917), 38–45. German translation: Math. Z. **26** (1927), 551–558.
- [5] W. Blaschke, *Vorlesungen über Differentialgeometrie I*. Springer, Grundlehren 1 (1921).
- [6] O. Bolza, *Vorlesungen über Variationsrechnung*. Koehler und Amelang, Leipzig 1949.
- [7] E. Bombieri, E. De Giorgi and E. Giusti, *Minimal cones and the Bernstein problem*. Inv. Math. **7** (1969), 243–268.
- [8] L. E. J. Brouwer, *Über Abbildung von Mannigfaltigkeiten*. Math. Ann. **71** (1912), 97–115.
- [9] R. Courant und D. Hilbert, *Methoden der Mathematischen Physik*. Band 1 und Band 2. Springer-Verlag, Berlin, 1968. English translation: *Methods of Mathematical Physics*. Vol. 1 and Vol. 2, Wiley-Interscience, 1962.
- [10] A. Cournot, *Researches into the Mathematical Principles of the Theory of Wealth*. Translation from French, New York, Kelley, 1960.

- [11] G. Debreu, *Existence of competitive equilibrium*. Handbook of Mathematical Economics, Vol. II North-Holland Publishing Company, pp. 697-743 (1982).
- [12] U. Dierkes, S. Hildebrandt, A. Küster and O. Wohlrab, *Minimal Surfaces*. I, II. Springer, Grundlehren 295, 296 (1992).
- [13] U. Dierkes, S. Hildebrandt and F. Sauvigny, *Minimal Surfaces*. Springer, Grundlehren 339 (2010).
- [14] L. C. Evans, *Partial Differential Equations*. Graduate Studies in Mathematics , Vol. 19, AMS, Providence, 1991.
- [15] L. C. Evans and R. F. Gariepy, *Measure Theory and Fine Properties of Functions*. Studies in Advanced Mathematics, CRC Press, Boca Raton, 1992.
- [16] R. Finn, *Equilibrium Capillary Surfaces*. Springer, Grundlehren 284 (1986).
- [17] J. Frehse, Zum Differenzierbarkeitsproblem bei Variationsungleichungen höherer Ordnung. Abhandl. Math. Seminar Hamburg **36** (1971), 140–149.
- [18] J. W. Friedman, *Game Theory with Applications to Economics*. Oxford University Press, New York, 1986.
- [19] M. Giaquinta and S. Hildebrandt, *Calculus of Variations*. I, II, Springer, Grundlehren 310, 311 (2004).
- [20] D. Gilbarg and N. S. Trudinger, *Elliptic Partial Differential Equations of Second Order*. Springer, Grundlehren 224 (1983).
- [21] H. Halkin, *On the necessary condition for optimal control of nonlinear systems*. J. Analyse Math. **12** (1964),1–82.
- [22] H. Heuser, Lehrbuch der Analysis II. Teubner-Verlag, Stuttgart, 1993.
- [23] M. R. Hestenes, *Calculus of Variations and Optimal Control Theory*. John Wiley & Sons, Inc. New York, 1966.
- [24] A. D. Ioffe und V. M. Tichomirov, *Theorie der Extremalaufgaben*. VEB Deutscher Verlag der Wissenschaften, Berlin, 1979. Translation from Russian.

- [25] J. Israelachvili, *Intermolecular and Surface Forces*. Academic Press, London, 1995.
- [26] J. Jost and X. Li-Jost, *Calculus of Variations*. Cambridge University Press, 1998.
- [27] S. Kakutani, *A generalisation of Brouwer's fixed point theorem*. Duke Math. J. **8** (1941), 457–459.
- [28] L. W. Kantorowitsch and G. P. Akilow, *Funktionalanalysis in normierten Räumen*. Translation from Russian. Akademie-Verlag, Berlin, 1964.
- [29] D. Kinderlehrer and G. Stampacchia, *An Introduction to Variational Inequalities and Their Applications*. Academic Press, New York, 1980.
- [30] B. Knaster, K. Kuratowski und S. Mazurkiewicz, *Ein Beweis des Fixpunktsatzes für  $n$ -dimensionale Simplexe*. Fund Mat. **14** (1929), 132–137.
- [31] H. W. Kuhn and A. W. Tucker, *Nonlinear programming*. Proc. of the Second Berkeley Symp. on Math. Stat. and Prob., Berkeley, Calif., 1951, 481–492.
- [32] H. Link, *Über den geraden Knickstab mit begrenzter Durchbiegung*. Ing.-Arch. **22** (1954), 237–250.
- [33] L. D. Landau and E. M. Lifschitz, *Lehrbuch der Theoretischen Physik*. Vol. 1., Akademie-Verlag, Berlin, 1964. German translation from Russian. English translation: *Course of Theoretical Physics*. Vol. 1, Pergamon Press, Oxford, 1976.
- [34] J. L. Lions, *Optimal Control Governed by Partial Differential Equations*. Translation from French, Springer, Berlin, 1971.
- [35] J.-L. Lions and E. Magenes, *Problèmes aux limites non homogènes et applications*. Dunod, Paris, 1968.
- [36] D. G. Luenberger, *Microeconomic Theory*. MacGraw-Hill Company, New York, 1995.
- [37] E. Miersemann, *Verzweigungsprobleme für Variationsungleichungen*. Math. Nachr. **65** (1975), 187 – 209.

- [38] E. Miersemann, *Über nichtlineare Eigenwertaufgaben in konvexen Mengen*. Math. Nachr. **88** (1979), 191 – 205.
- [39] E. Miersemann, *Über positive Lösungen von Eigenwertgleichungen mit Anwendungen auf elliptische Gleichungen zweiter Ordnung und auf ein Beulproblem der Platte*. ZAMM **59** (1979), 189–194.
- [40] E. Miersemann, *Zur Lösungsverzweigung bei Variationsungleichungen mit einer Anwendung auf den geraden Knickstab mit begrenzter Durchbiegung*. Math. Nachr. **102** (1981), 7 – 15.
- [41] E. Miersemann, *Wetting barriers*. Calc. Var. **15** (2002), 237 – 256.
- [42] E. Miersemann, *Kapillarflächen*. Ber. Verh. Sächs. Akad. Wiss. Leipzig, Math.-Natur. Kl. **130** (2008), Heft 4, S. Hirzel, Leipzig, 2008.
- [43] E. Miersemann and H. D. Mittelmann, *A free boundary problem and stability for the circular plate*. Math. Meth. in the Appl. Sci. **9** (1987), 240–250.
- [44] E. Miersemann and H. D. Mittelmann, *A free boundary problem and stability for the rectangular plate*. Math. Meth. in the Appl. Sci. **12** (1990), 129–138.
- [45] J. J. Moreau, *Décomposition orthogonale dans un espace HILBERTien selon deux cônes mutuellement polaires*. C. R. Acad. Sci., Paris **255** (1962), 238–240.
- [46] J. F. Nash, *Equilibrium points in  $N$ -person games*. Proceedings Nat. Acad. Sciences, U.S.A., **36** (1950), 48-49.
- [47] R. Osserman, *A Survey of Minimal Surfaces*. Dover Publications (1986).
- [48] L. S. Pontryagin, V. G. Boltjanskij, R. V. Gamkrelidze und E. F. Miščenko, *The Mathematical Theory of Optimal Processes*. 2nd Edition, Moscow, 1969 (in Russian). Translations into German (1964) and English (1962), for example, exist from the first edition.
- [49] R. T. Rockafellar and R. J.-B. Wets, *Variational Analysis*. Springer, Grundlehren 317 (1998)
- [50] R. T. Rockafellar, *Convex Analysis*. Princeton University Press, 1970.



- [51] M. Roscher, Fortsetzung lokaler Nash-Gleichgewichte. Diplomarbeit. Department of Mathematics, Leipzig University, 1999.
- [52] H. Sagan, *Introduction to the Calculus of Variations*. Dover, New York, 1992.
- [53] L. Scheeffer, *Über die Bedeutung der Begriffe "Maximum und Minimum" in der Variationsrechnung*. Math. Annalen **26** (1886), 197–208.
- [54] P. Schiller, H.-J. Mögel and E. Miersemann, *Stability of liquid layers on solid materials*. J. math. fluid mech. **12** (2) (2010), 293–305.
- [55] A. Seierstad and K. Sydsæter, *Optimal Control Theory with Economic Applications*. North-Holland, Amsterdam, 1987.
- [56] J. Simons, *Minimal varieties in riemannian manifolds*. Ann. of Math(2) **88** (1968), 62–105.
- [57] M. Struwe, *Variational Methods*. Springer, 1980.
- [58] A. Takayama, *Mathematical Economics*. Cambridge University Press 1985.
- [59] J. L. Troutman, *Variational Calculus and Optimal Control; Optimization with Elementary Convexity*. Springer, 1996.
- [60] E. Zeidler, *Nonlinear Functional Analysis and its Applications. III Variational Methods and Optimizations*. Springer, 1985.

# Index

- adjoint function 172
- basic lemma 12
- beam
  - bending 124, 125
  - stability 158
- brachistochrone 13, 121
- Brouwer's fixed point theorem 184
- characteristic of a function 132
- capillary equation 26
- cone 42
  - tangent cone 43, 106
- convex
  - set 40, 90
  - functional 40
  - strictly 40
- conjugate point 117
- critical load
  - equation 15
  - summerhouse 16
  - variational inequality 17
  - optimal design 18
- differentiable
  - totally 47
  - Fréchet 106
  - Gâteaux 106
- Dirichlet integral 22
- Du Bois-Reymond lemma 111
- eigenvalue
  - equation 10, 73
  - variational inequality 11, 77
  - positive solutions 143
- Euler equation
  - ordinary differential equation 11
  - partial differential equation 22
- Euler's polygonal method 20
- extremal 111
- free boundary conditions 123
- game
  - noncooperative 79
  - oligopoly 80
- geodesic curve 14, 140
- Hilbert's invariant integral 167
- isoperimetric problems 31
- Jacobi equation 117
- Jacobi condition 117, 118
- Kuhn-Tucker
  - conditions 55, 69
  - theorem 67
- Lagrange multipliers
  - $\mathbb{R}^n$ , equations 50, 56
  - $\mathbb{R}^n$ , inequalities 51, 54
  - Hilbert space, equations 99
  - Hilbert space, variational inequalities 99
  - ordinary differential equations 136, 137, 138
- Legendre condition 115, 116, 120
- Legendre transformation 119
- liquid layers 29
- Mayer's variational problem 179
- minimal surface
  - rotationally symmetric 12
  - minimal surface equation 23

- minimum
  - global 39
  - strict global 39
  - local 39
  - strict local 40
  - weak 105, 110
  - strong 106, 111
- minimum-maximum principle 76
- Minkowski-Farkas lemma 95
- Moreau's decomposition lemma 97
- Nash equilibrium 10, 81
- N-body problem 122
- nonsmooth solutions 129
- necessary conditions
  - first order 47, 109
  - second order 49, 55, 115
- optimal control 21, 171
- optimal trajectory 21, 171
- Pontryagin's maximum principle 172
- projection 48, 96
- regular point
  - Lagrange multiplier method 54
  - optimal control 171
- regularity 112
- Riccati equation 119
- saddle point 19, 65
- separation of sets 91, 93
- Slater condition 68
- sufficient conditions
  - $\mathbb{R}^n$ , equations 61
  - $\mathbb{R}^n$ , inequalities 62
  - weak minimizers 149
  - strong minimizers 164
- transversality conditions 125, 126, 127, 128
- variations 107
  - needle variations 176, 180
- variational inequalities 48, 141, 142, 155, 158
- Weierstrass-Erdmann corner condition 130
- Weierstrass excess function 168