

Air Quality Decision Support System for *Portable Sources*



Spring 2004
Montana State University

Jack Dartman
Date: April, 2004



Summary

Air quality permits are issued for both stationary and *portable* sources of emissions. The Prototype Air Quality Decision Support System (AQDSS) discussed in this paper has limited its scope to portable sources to simplify the development process. Examples of portable sources are:

- Asphalt & Cement Concrete Batch Plants, and
- Crushing & Screening Plants.

Portable Sources of Air Pollution are Subject to Various State and Federal Permitting Requirements Dependant Upon: the quantity and nature of emissions, the date of manufacture of equipment, the proposed location(s) and dates of operation, the hours of operation, as well as other factors that the decision support system (DSS) must address.

An AQDSS for portable sources should accept air quality permit application data, and model the data to generate a recommendation. AQDSS permit recommendations are:

- Issue an Air Quality Permit (for a Portable Source),
- Issue with Permit Restrictions (Emission Limits, Hours of Operation Limits, Production Limits,),
- Application Incomplete - Request Additional Information,
- Do Not Issue Permit,
- Does Not Require Permit,
- Requires Operating Permit.

An objective of this project, secondary to satisfying the requirements of a Master of Science Degree, was to construct a prototype AQDSS that attempts to satisfy the needs (requirements) of the Montana Department of Environmental Quality (DEQ), Air Resources Management Bureau. With that perspective in mind, the AQDSS was intended to facilitate the issuance of air quality permits for portable sources, with the goal of improving DEQ response time and reducing engineer review time. The AQDSS should also, when fully completed, provide an opportunity for an air quality permit applicant to complete and submit an application online.

A working prototype can also provide a useful template to expand the DSS to other types of source categories, as well as facilitate communication between the DEQ and the regulated community.

Table of Contents

Summary	3
Table of Contents	5
Table of Figures	6
Tables	6
Project Description.....	7
Air Quality Standards and Permitting Requirements.....	9
Montana’s Permitting Criteria.....	9
New Source Performance Standards (NSPS).....	9
Emission Estimation Using Emission Factors	10
Ambient Air Quality Standards.....	10
National Ambient Air Quality Standards.....	11
State Implementation Plan	11
Federal and State Primary Ambient Air Quality Pollutant Standards.....	12
Project Implementation	13
Database	13
Description	13
ER Diagram – AQDSS.....	15
AQDSS Table Attributes.....	16
Schema – AQDSS	17
Database Tables.....	18
Table air_pol_control_equip	18
Table apce_stack	18
Table app_detail_status	19
Table emissionfactor	19
Table emissions	19
Table operating_sched.....	20
Table permit_applicant.....	20
Table process_equipment.....	20
Table eu_fuel.....	21
Table source_location	21
DSS Models	22
Air Quality Dispersion Model.....	22
Screen3 Model Input	23
Access to the AQDSS.....	26
AQDSS Site Navigation.....	27
AQDSS Permit Application – Applicant Information	28
AQDSS Permit Application – Emission Inventory.....	30
AQDSS Permit Application – Process Equipment	31
AQDSS Permit Application – Operating Schedule.....	32
AQDSS Permit Application – Air Pollution Control Equipment	33
AQDSS Permit Application – Stack Data.....	34
AQDSS Model Data Input	35
AQDSS Permit Application – Edit and Review.....	36

AQDSS Database Query	37
AQDSS Database Query	38
Air Quality Decision Support.....	39
DSS– Action.....	40
Alternative DSS Database Tools.....	41
phpMyAdmin	41
Conclusions	42
Lesson’s Learned.....	42
Features	42
Features to Add	42
Problems Encountered.....	42
Final Observations	43
Bibliography & Resources	44
References	44
Links.....	44
Air Quality Links	44
Glossary.....	45
Appendices.....	47
Selected PHP Scripts / HTML Forms	47
Screen3 Manual Excerpts.....	68

Table of Figures

Figure 1 – Time Averaged Gaussian Plume.....	22
Figure 2 – Gaussian Plume.....	22

Tables

Federal and State Ambient Air Quality Standards	12
Database Tables	18

Project Description

The prototype Air Quality Decision Support System for Portable Sources (AQDSS) was implemented to satisfy the project requirements for a Master of Science Degree. The DBMS (database management system) employed is MySQL, and the database will be demonstrated in the MySQL environment. Access to the database is provided using a web-based, graphical user interface that employs Apache server, and the scripting language PHP.

The practical use of the project when implemented would be as an air quality permit modeling and decision tool for portable sources. However, the system could easily be altered to support alternative air quality permitting source categories, such as compressor stations. MySQL database, PHP, and Apache server are widely used and accepted for internet business applications. In fact, these tools have been very influential in the adoption of open source software. Apache is by far the dominant HTTP (Hyper Text Transfer Protocol) server used on the internet. PHP is growing in popularity, and now appears to be the server-side scripting language of choice (PHP is a project of the Apache Software Foundation). What is even more noteworthy, the (software) cost to implement a solution such as described by this project is “zero.”

The modeling has two components. The first component is integral to the DSS. The second modeling component is an external air quality dispersion model that calculates ambient air impacts from emissions. When implemented, the user can set the DSS to call the model, and return with the modeled output. The modeled output would then be used in part of the decision logic for the first modeling component. The programming language used to author the external dispersion model, ‘SCREEN3’, is FORTRAN. SCREEN3 is a regulatory model provided by EPA.

The structure of this project is restated below for clarification.

Client-side: The local (client) side of the system is simply the user’s desktop or local machine running their web browser of choice. This is a simple and elegant method, and doesn’t require expensive tools, software, or hardware. It is also very secure and manageable.

Server-side: The database management system (MySQL), the scripting language (PHP), and the http server (Apache) reside on the server. The server can be a separate (remote) computer, a separate but local computer, or the same computer designated for local use and browsing.

MySQL has an API (Application Programming Interface) that allows PHP to communicate very efficiently with the DBMS. MySQL also has API’s for ODBC, C/C++, Java, Perl (DBI), Python, and .NET. MySQL does not have an API for FORTRAN, the programming language used to author the external dispersion model for this DSS, ‘SCREEN3’. MySQL developers have maintained two goals while expanding the features and capabilities of the MySQL DBMS: speed is the first, and the second is reliability and robustness. These qualities are very important for internet based applications, and it helps to explain the dramatic increase in use of MySQL in the

past several years. These same qualities are important to any internet based application such as the AQDSS prototype for this class project.

PHP works extremely well with MySQL, however PHP also works well with other DBMS, including Access, PostgreSQL, Oracle, DB2, to name only a few. PHP, whose growth can be attributed partly to the success of Apache, has increased its capabilities many times over. The PEAR group (PHP Extension and Application Repository) has promoted the standardization of new PHP features, which is making PHP even more useful and ubiquitous.

Air Quality Standards and Permitting Requirements

Portable sources of air pollution are subject to various state and federal permitting requirements dependant upon:

- Quantity and Nature of Emissions;
- Date of Manufacture of Equipment;
- Proposed Location(s) of Operation; and
- Dates of Operation.

Air quality permitting requirements for this source category are derived from:

- Montana Clean Air Act (Section 75, Chapter 2);
- Montana Air Quality Rules (ARM Chapter 17.8);
- Montana State Implementation Plan (SIP);
- Montana Ambient Air Quality Standards (ARM 17.8.Subchapter 2);
- National Ambient Air Quality Standards (NAAQS);
- New Source Performance Standards (NSPS); and
- Operating Permits (100 tons/year or greater of any regulated pollutant).

Montana's Permitting Criteria

Permit applications for construction and operation of air contaminant sources are required for all emission sources that meet or exceed the 'Potential to Emit' (PTE) permitting threshold for any regulated pollutant (Tons Per Year = Tons/Year = TPY = T/Y):

- 25 TPY of PM, PM10, SO_x, NO_x, PB, VOC, and CO (Montana requires a minor-source preconstruction permit);
- 25 TPY of all Hazardous Air Pollutants (HAP's) combined (Operating Permit);
- 10 TPY of Any individual HAP (Operating Permit); and
- 100 TPY of Any Regulated Pollutant (Operating Permit).

New Source Performance Standards (NSPS)

Emission sources subject to NSPS (40CFR Part 60) will also be required to meet the performance requirements specified by NSPS. NSPS is applicable if specific criteria are met:
Example: Date of Manufacture or Production Capacity.

- NSPS specifies that emissions for applicable sources cannot exceed specified requirements.
- NSPS also requires BACT – Best Available Control Technology, among other requirements.

Emission Estimation Using Emission Factors

Emission estimation calculations employed to determine permitting requirements, and to estimate ambient air impacts, typically use emission factors, emission data acquired from previous stack testing (source testing), or manufacturer data. Emission calculations for this source category look very similar to the examples that follow.

$$\text{Emission Factor} \times \begin{array}{c} \text{Production Rate} \\ \text{or} \\ \text{Corrected Stack Flow Rate} \\ \text{or} \\ \text{Fuel Consumption Rate} \end{array} \times \text{Hrs Operation}$$

Examples:

$$0.04 \text{ gr/dscf} \times 39388 \text{ dscf} \times 11\text{b}/7000\text{gr} \times 60 \text{ min/hr} = 13.5 \text{ lbs/hr}$$
$$13.5 \text{ lbs/hr} \times 8760 \text{ hrs/yr} \times 2000\text{lbs/ton} = 59.13 \text{ tons/yr (PM).}$$

$$0.024 \text{ lbs/hp-hr} \times 975 \text{ hp} = 23.4 \text{ lbs/hr}$$
$$23.4 \text{ lbs/hr} \times 8760 \text{ hrs/yr} \times 2000 \text{ lbs/yr} = 102.5 \text{ tons/yr (NOx).}$$

Ambient Air Quality Standards

Under the Clean Air Act of 1970, EPA Developed National Ambient Air Quality Standards (NAAQS) for criteria pollutants. Currently there are seven criteria pollutants:

- Particulate Matter (PM),
- Fine Particulate Matter (PM10),
- Lead (PB),
- Sulfur Dioxide (SO₂),
- Nitrogen Oxides (NO_x),
- Carbon Monoxide (CO), and
- Ozone (O₃).

The above standards were the first federal air quality guidelines promulgated to protect human health and environment in the United States. Subsequently, Montana and other states either established equivalent or more stringent standards for the above pollutants. In some instances states established standards for pollutants that were not criteria pollutants. Montana was one such state and established standards for the pollutants such as Flouride, Hydrogen Sulfide, Settleable Particulate, and Visibility. Montana also established a smoke management program.

National Ambient Air Quality Standards

- **Primary Standards** are designed to protect human health, including "sensitive" populations, such as people with asthma and emphysema, children, and senior citizens. (*Primary standards were designed for the immediate protection of public health, with an adequate margin of safety, regardless of cost.*)
- **Secondary standards** are designed to protect public welfare, including soils, water, crops, vegetation, buildings, property, animals, wildlife, weather, visibility, and other economic, aesthetic, and ecological values, as well as personal comfort and well-being. (*Secondary standards were established to protect the public from known or anticipated effects of air pollution.*)

State Implementation Plan

The State Implementation Plan, or 'SIP', is the management plan adopted by the state, and approved by the US EPA, to abate and monitor emissions from all air pollution sources located in areas that are designated as non-attainment for any of the criteria pollutants. An area is designated as a non-attainment area if either a monitored or modeled exceedance of an air quality standard occurs.

Portable sources of air pollution operate in non-attainment areas – *that is*, areas that have already exceeded health-based standards like the NAAQS. As incentive to protect the NAAQS, the US EPA can withhold highway transportation funding, and other federal funding, if a state fails to demonstrate progress towards protecting an ambient air quality standard.

Montana's SIP is organized by county. Each County with one or more non-attainment areas must also have control plans in the SIP to mitigate pollution and improve air quality for the specific ambient standards that have been exceeded. The counties that have non-attainment areas for one or more criteria pollutants may also have local air pollution control authorities, and may also have local air quality ordinances or county rules. Portable sources of air pollutants, such as the crushers, asphalt, and concrete plants in this source category, will usually need to operate in areas of non-attainment for specific periods.

Federal and State Primary Ambient Air Quality Pollutant Standards

Pollutant	Time Period	Federal	Montana
Carbon Monoxide	Hourly Average	35 ppm ^a	23 ppm ^a
	8-Hour Average	9 ppm ^a	9 ppm ^a
Fluoride in Forage	Monthly Average		50 mg/g ^b
	Grazing Season		35 mg/g ^b
Hydrogen Sulfide	Hourly Average		0.05 ppm ^a
Lead	90-Day Average		1.5 mg/m ^{3b} (rolling)
	Quarterly Average	1.5 mg/m ^{3b} (calendar)	
Nitrogen Dioxide	Hourly Average		0.30 ppm ^a
	Annual Average	0.053 mg/m ³	0.05 ppm ^b
Ozone	Hourly Average	0.12 ppm ^c	0.10 ppm ^a
PM-10 (existing)	24-Hour Average	150 mg/m ^{3 d,j}	150 mg/m ^{3 d,j}
	Annual Average	50 mg/m ^{3 e}	50 mg/m ^{3 e}
PM-10 (revised)	24-Hour Average	150 mg/m ^{3 f,j}	
	Annual Average	50 mg/m ^{3 e}	
PM-2.5	24-Hour Average	65 mg/m ^{3 g,j}	
	Annual Average	15 mg/m ^{3 h}	
Settleable Particulate	30-Day Average		10 g/m ^{2b}
Sulfur Dioxide	Hourly Average		0.50 ppm ⁱ
	3-Hour Average	0.50 ppm ^k	
	24-Hour Average	0.14 ppm ^{j,k}	0.10 ppm ^{aj}
	Annual Average	0.03 ppm ^k	0.02 ppm ^k
Visibility	Annual Average		3 X 10 ⁻⁵ /m ^k

a Federal violation when exceeded more than once per calendar year.

b Not to be exceeded (ever) for the averaging time period as described in the regulation.

c Not to be exceeded more than once per year averaged over 3-years.

d Violation occurs when the expected number of days per calendar year with a 24-hour average above this concentration is more than one.

e Violation occurs when the expected annual arithmetic mean concentration is above this concentration.

f To attain this standard, the 99th percentile of the distribution of the 24-hour concentrations for one year, averaged over three years, must not exceed this concentration at each monitor within an area.

g To attain this standard, the 98th percentile of the distribution of the 24-hour concentrations for one year, averaged over three years, must not exceed this concentration at each monitor within an area.

h To attain this standard, the 3-year average of the annual arithmetic mean of the 24-hour concentrations from a single or multiple population oriented monitors must not exceed this concentration.

i State violation when exceeded more than eighteen times in any 12 consecutive months.

j The standard is based upon a calendar day (midnight to midnight).

k Standard never to be exceeded during a calendar year.

Project Implementation

Database

The design of the database was kept as simple as possible; however, it is *not* a simple database. The AQDSS prototype has been restricted to a source category that is relatively uncomplicated in an effort to simplify the design and implementation. The data is a subset of the DEQ air permitting database tables. The basic structure implemented has ten tables. The basic goal for the database was to achieve third normal form (3NF) whenever practicable, and to satisfy the requirements of the DEQ. The original DEQ structure is not fully normalized, and does not satisfy third normal form. The database for this prototype is also not fully normalized, but does satisfy the requirements of the DEQ.

Description

The ER diagram, database schema, and the tables provide the clearest description. The diagram, schema, and tables follow.

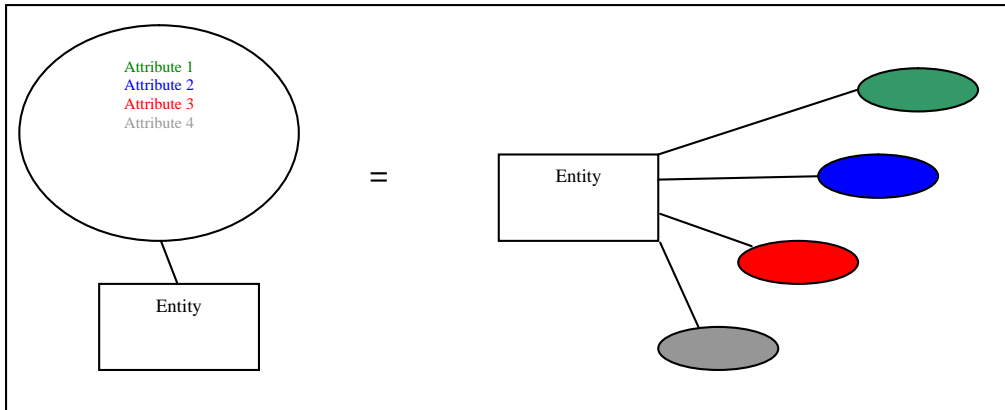

ER Diagram – AQDSS

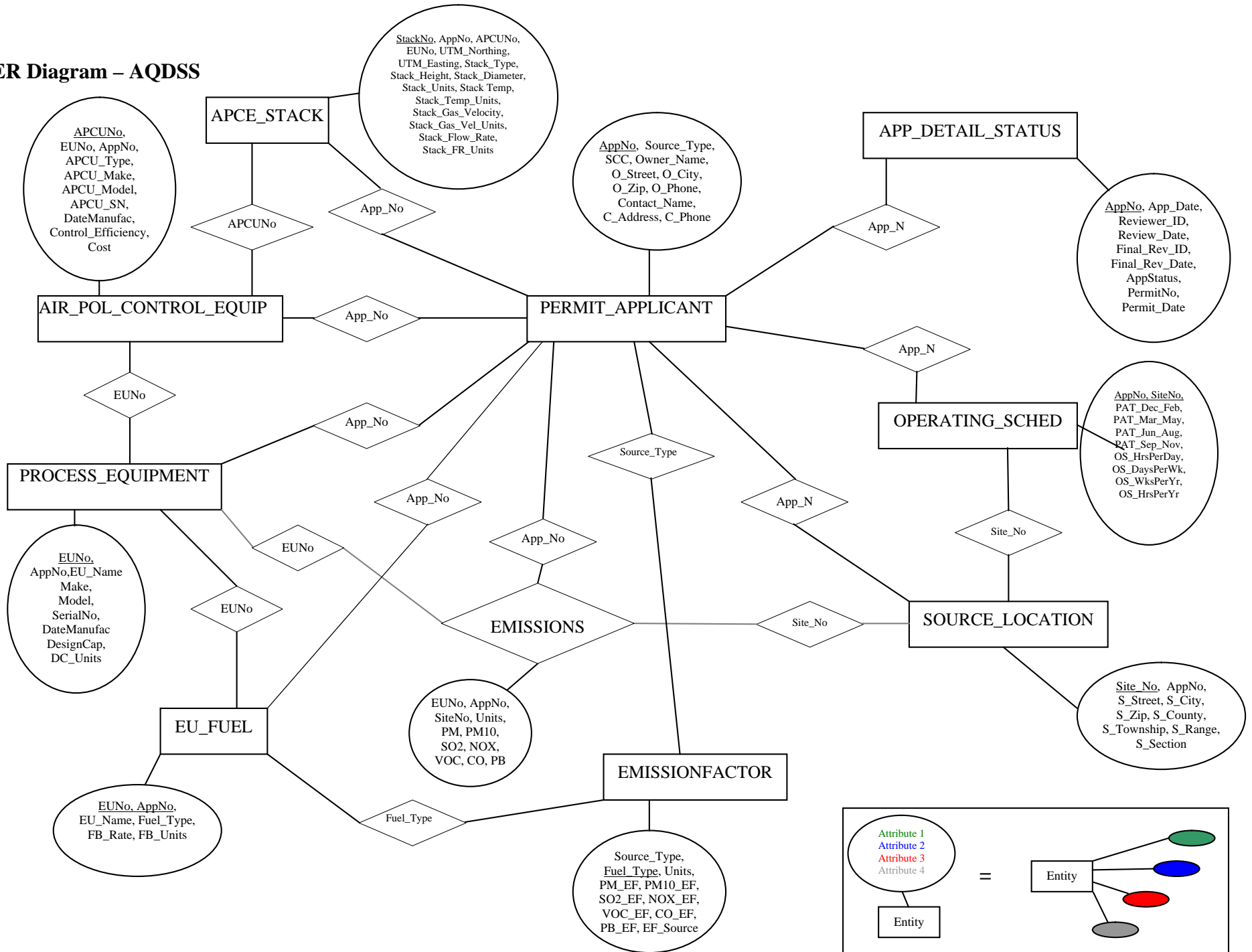

AQDSS Table Attributes

PERMIT_APPLICANT

AppNo, Source_Type, SCC, Owner_Name, O_Street, O_City, O_Zip, O_Phone Contact_NameC_AddressC_Phone

SOURCE_LOCATION

Site_No, AppNo, S_Street, S_City, S_Zip, S_County, S_Township, S_Range, S_Section

PROCESS_EQUIPMENT

EUNo, AppNo, EU_Name, Make, Model, SerialNo, Date, ManufacDesignCap, DC_Units

EU_FUEL

EUNo, AppNo, EU_Name, Fuel_Type, FB_Rate, FB_Units

AIR_POL_CONTROL_EQUIP

APCUNo, AppNo, EUNo, APCU_Type, APCU_Make, APCU_Model, APCU_SN, DateManufac, Control_Efficiency, Cost

APCE_STACK

StackNo, AppNo, APCUNo, EUNo, APCU_Type, UTM_Northing, UTM_Easting, Stack_Type, Stack_Height, Stack_Diameter, Stack_Units, Stack_Temp, Stack_Temp_Units, Stack_Gas_Velocity, Stack_Gas_Vel_Units, Stack_Flow_Rate, Stack_FR_Units

EMISSIONS

EUNo, AppNo, SiteNo, Units, PM, PM10, SO2, NOX, VOC, CO, PB

EMISSIONFACTOR

Source_Type, Fuel_Type, Units, PM_EF, PM10_EF, SO2_EF, NOX_EF, VOC_EF, CO_EF, PB_EF, EF_Source

OPERATING_SCHED

AppNo, SiteNo, PAT_Dec_Feb, PAT_Mar_May, PAT_Jun_Aug, PAT_Sep_Nov, OS_HrsPerDay, OS_DaysPerWk, OS_WksPerYr, OS_HrsPerYr

APP_DETAIL_STATUS

AppNo, App_Date, Reviewer_ID, Review_Date, Final_Rev_ID, Final_Rev_Date, AppStatus, PermitNo, Permit_Date

Schema – AQDSS

PERMIT_APPLICANT

AppNo	Source_Type	SCC	Owner_Name	O_Street	O_City	O_Zip	O_Phone
-------	-------------	-----	------------	----------	--------	-------	---------

Contact_Name	C_Address	C_Phone
--------------	-----------	---------

SOURCE_LOCATION

Site_No	App_No	S_Street	S_City	S_Zip	S_County	S_Township	S_Range	S_Section
---------	--------	----------	--------	-------	----------	------------	---------	-----------

PROCESS_EQUIPMENT

EUNo	AppNo	EU_Name	Make	Model	SerialNo	DateManufac	DesignCap	DC_Units
------	-------	---------	------	-------	----------	-------------	-----------	----------

EU_FUEL

EUNo	AppNo	EU_Name	Fuel_Type	FB_Rate	FB_Units
------	-------	---------	-----------	---------	----------

AIR_POL_CONTROL_EQUIP

APCUNo	EUNo	AppNo	APCU_Type	APCU_Make	APCU_Model	APCU_SN	DateManufac
--------	------	-------	-----------	-----------	------------	---------	-------------

Control_Efficiency	Cost
--------------------	------

APCE_STACK

StackNo	AppNo	APCUNo	EUNo	UTM_Northing	UTM_Easting	Stack_Type	Stack_Height
---------	-------	--------	------	--------------	-------------	------------	--------------

Stack_Diameter	Stack_Units	Stack_Temp	Stack_Temp_Units	Stack_Gas_Velocity
----------------	-------------	------------	------------------	--------------------

Stack_Gas_Vel_Units	Stack_Flow_Rate	Stack_FR_Units
---------------------	-----------------	----------------

EMISSIONS

EUNo	AppNo	SiteNo	Units	PM	PM10	SO2	NOX	VOC	CO	PB
------	-------	--------	-------	----	------	-----	-----	-----	----	----

EMISSIONFACTOR

Source_Type	Fuel_Type	Units	PM_EF	PM10_EF	SO2_EF	NOX_EF	VOC_EF
-------------	-----------	-------	-------	---------	--------	--------	--------

CO_EF	PB_EF	EF_Source
-------	-------	-----------

OPERATING_SCHED

AppNo	SiteNo	PAT_Dec_Feb	PAT_Mar_May	PAT_Jun_Aug	PAT_Sep_Nov	OS_HrsPerDay
-------	--------	-------------	-------------	-------------	-------------	--------------

OS_DaysPerWk	OS_WksPerYr	OS_HrsPerYr
--------------	-------------	-------------

APP_DETAIL_STATUS

AppNo	App_Date	Reviewer_ID	Review_Date	Final_Rev_ID	Final_Rev_Date
-------	----------	-------------	-------------	--------------	----------------

AppStatus	PermitNo	Permit_Date
-----------	----------	-------------

Database Tables

Table air_pol_control equip

Table comments : InnoDB free: 3072 kB

Field	Type	Null	Default
APCUNo	int(11)	No	
EUNo	int(11)	No	0
AppNo	int(11)	No	0
APCU_Type	varchar(20)	No	
APCU_Make	varchar(20)	No	
APCU_Model	varchar(20)	No	
APCU_SN	varchar(20)	No	
DateManufac	date	No	0000-00-00
Control_Efficiency	float	No	0
Cost	varchar(10)	No	

Table apce_stack

Table comments : InnoDB free: 3072 kB

Field	Type	Null	Default
StackNo	int(11)	No	
AppNo	int(11)	No	0
APCUNo	int(11)	No	0
EUNo	int(11)	No	0
UTM_Northing	varchar(20)	No	
UTM_Easting	varchar(20)	No	
Stack_Type	varchar(15)	No	
Stack_Height	float	No	0
Stack_Diameter	float	No	0
Stack_Units	varchar(15)	No	
Stack_Temp	float	No	0
Stack_Temp_Units	varchar(15)	No	
Stack_Gas_Velocity	float	No	0
Stack_Gas_Vel_Units	varchar(15)	No	
Stack_Flow_Rate	float	No	0
Stack_FR_Units	varchar(15)	No	

Table app_detail_status

Table comments : InnoDB free: 3072 kB

Field	Type	Null	Default
AppNo	int(11)	No	0
App_Date	date	No	0000-00-00
Reviewer_ID	varchar(15)	Yes	NULL
Review_Date	date	Yes	NULL
Final_Rev_ID	varchar(15)	Yes	NULL
Final_Rev_Date	date	Yes	NULL
AppStatus	varchar(30)	Yes	NULL
PermitNo	date	Yes	NULL
Permit_Date	date	Yes	NULL

Table emissionfactor

Table comments : InnoDB free: 3072 kB

Field	Type	Null	Default
Source_Type	varchar(15)	No	
Fuel_Type	varchar(15)	No	
Units	varchar(15)	No	
PM_EF	float	No	0
PM10_EF	float	No	0
SO2_EF	float	No	0
NOX_EF	float	No	0
VOC_EF	float	No	0
CO_EF	float	No	0
PB_EF	float	No	0
EF_Source	varchar(30)	No	

Table emissions

Table comments : InnoDB free: 3072 kB

Field	Type	Null	Default
EUNo	int(11)	No	0
AppNo	int(11)	No	0
SiteNo	int(11)	No	0
Units	varchar(15)	No	
PM	float	No	0
PM10	float	No	0
SO2	float	No	0
NOX	float	No	0
VOC	float	No	0
CO	float	No	0
PB	float	No	0

Table operating_sched

Table comments : InnoDB free: 3072 kB

Field	Type	Null	Default
AppNo	int(11)	No	0
SiteNo	int(11)	No	0
PAT_Dec_Feb	float	No	0
PAT_Mar_May	float	No	0
PAT_Jun_Aug	float	No	0
PAT_Sep_Nov	float	No	0
OS_HrsPerDay	int(11)	No	0
OS_DaysPerWk	int(11)	No	0
OS_WksPerYr	int(11)	No	0
OS_HrsPerYr	int(11)	No	0

Table permit_applicant

Table comments : InnoDB free: 3072 kB

Field	Type	Null	Default
AppNo	int(11)	No	
Source_Type	varchar(25)	No	
SCC	varchar(16)	No	
Owner_Name	varchar(30)	No	
O_Street	varchar(15)	No	
O_City	varchar(12)	No	
O_Zip	varchar(10)	No	
O_Phone	varchar(12)	No	
Contact_Name	varchar(30)	No	
C_Address	varchar(30)	No	
C_Phone	varchar(12)	No	

Table process_equipment

Table comments : InnoDB free: 3072 kB

Field	Type	Null	Default
EUNo	int(11)	No	
AppNo	int(11)	No	0
EU_Name	varchar(30)	No	
Make	varchar(20)	No	
Model	varchar(20)	No	
SerialNo	varchar(20)	No	
DateManufac	date	No	0000-00-00
DesignCap	int(11)	No	0
DC_Units	varchar(15)	No	

Table eu_fuel

Table comments : InnoDB free: 3072 kB

Field	Type	Null	Default
EUNo	int(11)	No	0
AppNo	int(11)	No	0
EU_Name	varchar(30)	No	
Fuel_Type	varchar(15)	No	
FB_Rate	float	No	0
FB_Units	varchar(15)	No	

Table source_location

Table comments : InnoDB free: 3072 kB

Field	Type	Null	Default
SiteNo	int(11)	No	
AppNo	int(11)	No	0
Source_Type	varchar(15)	No	
S_Street	varchar(15)	No	
S_City	varchar(12)	No	
S_Zip	varchar(10)	No	
S_County	varchar(30)	No	
S_Township	varchar(20)	No	
S_Range	varchar(20)	No	
S_Section	varchar(15)	No	

DSS Models

The prototype AQDSS incorporates two modeling functions:

- 1) The Basic DSS provides simple yet effective logic to provide the decision maker recommendations on permit Issuance.
- 2) The DSS will also call an external AQ dispersion model to determine estimated ambient impacts.

Air Quality Dispersion Model

Models use emission rates, stack data, terrain data, and meteorological data, to calculate predicted ground-level concentrations of emissions at various receptor points such as facility property boundaries. The simplest models are Gaussian plume models that make numerous simplifying assumptions at the expense of accuracy (SCREEN3). Even though the model output is less accurate, the use of conservative models result in emission limits that are lower, and therefore protective of the NAAQS.

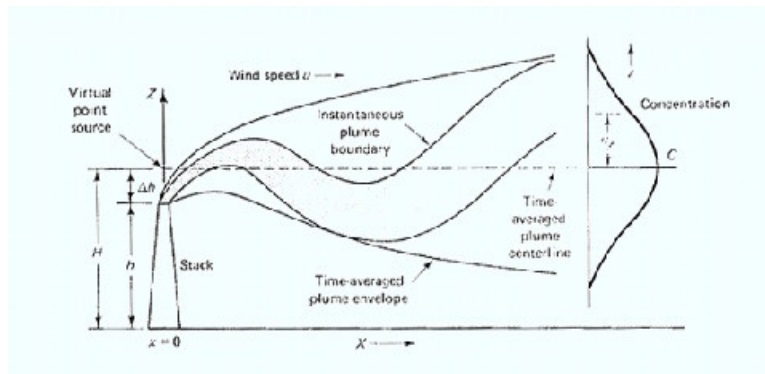

Figure 1 – Time Averaged Gaussian Plume (Turner)

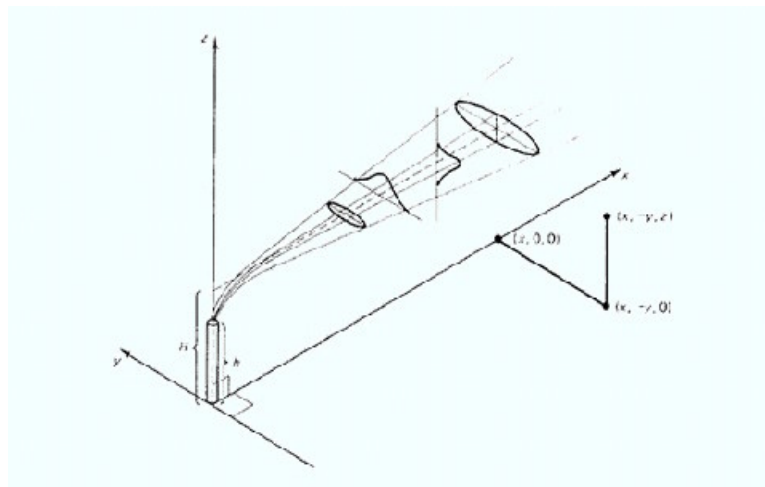

Figure 2 – Gaussian Plume (Turner)

Screen3 Model Input

- Title of Run
- Source Type [P, F, A, V] Point, Flare, Area, Volume
- Emission Rate [G/S] Grams/Second
- Stack Height [M] Meters
- Stack Inside Diameter [M]

- Stack Gas Exit Velocity[M/S] Meters/Second
- Alternatives
- 'vm='before value changes input to Meters³/Second
- 'vf='before value changes input to ACFM

- Stack Gas Exit Temp. [K] Kelvin
- Ambient Air Temp [K]
- Receptor Height Above Ground (Flagpole Receptor) [M]
- Urban / Rural Option [U or R]
- Consider Building Downwash? [Y or N] Yes or No
- Use Complex Terrain Screen for Terrain Above Stack Height? [Y or N]
- Use Simple Terrain Screen with Terrain Above Stack Base? [Y or N]

- Meteorology Choice: [1 or 2 or 3]
- 1 – Full Met (All stabilities and wind speeds)
- 2 – Single Stability Class
- 3 – Single Stability Class and Wind Speed

- if 2, enter stability A through F: [1=A, 2=B, ..., 6=F]
- if 3, enter stability, and then enter wind speed [M/S]

- Automated Distance Array [Y or N]
- Terrain Height above stack base [M]
- Min and Max Distances to Use [M]
- Continue Simple terrain automated calcs with new terrain height? [Y or N]
- Use Discrete Distances? [Y or N]
- Print Hard Copy [Y or N]

The Appendix includes a portion of the manual for SCREEN3, and provides additional information about model input values.

The decision support system identifies several criteria, and provides a recommendation to the decision maker (permit engineer) to either:

- issue an air quality permit (for a portable source),
- issue with permit restrictions (emission limits, hours of operation restrictions, production limits, performance requirements (grain loading), etc....),
- request additional information (application incomplete),
- do not issue permit,
- applicant does not require permit,
- applicant requires an operating permit.

The first and most significant decision criteria are the potential emissions (PE) of each of the regulated pollutants emitted by the portable source. After the potential emissions are determined and evaluated, the DSS can determine if additional requirements or restrictions are required. The remaining decision criteria are also important: whether the source will be located in a SIP non-attainment area, if the source is subject to NSPS, and requires a BACT analysis, if the application is complete, if the application fee has been submitted. These decision criteria are the core decision elements that have to be considered for inclusion in this prototype DSS. AQDSS Model Decision Logic is represented by the following:

```

if(!$NSPS){
  if($PE<25.0){
    $DSS=1; // Does Not Require a Permit
    $Done=True;}
  elseif($PE>=100){
    $DSS=6; // Requires an Operating Permit
    $Done=True;}
  else{
    if ($AppComp && $AppFee){
      if($SiteNo != ($C||$W||$K||$L||$T||$M||$B||$P)){
        $DSS=2; // Issue AQ Permit for Portable
        $Done=True;}
      else{
        $DSS=3; // Issue Permit with Restrictions
        $Done=True;}
      endif}
    elseif (!AppComp || !$AppFee);{
      $DSS=4; // Application Incomplete
      $Done=True;}
    endif}
    $DSS=5; // Do Not Issue Permit
    $Done=True;
  endif}
else{
  $DSS=3; $BACT=True; // Issue Permit with Restrictions
  $Done=True;
endif

```

User Interface

The user interface for this prototype AQDSS implies that the database was meant to be an internet application. This is indeed the case...a dynamic internet application. The user interface is best understood by scrutinizing the following screen shots which shows how to gain access to the DSS, as well as the DSS modeling functionality. Full access to the database can be achieved through a web browser (either locally or on-line).

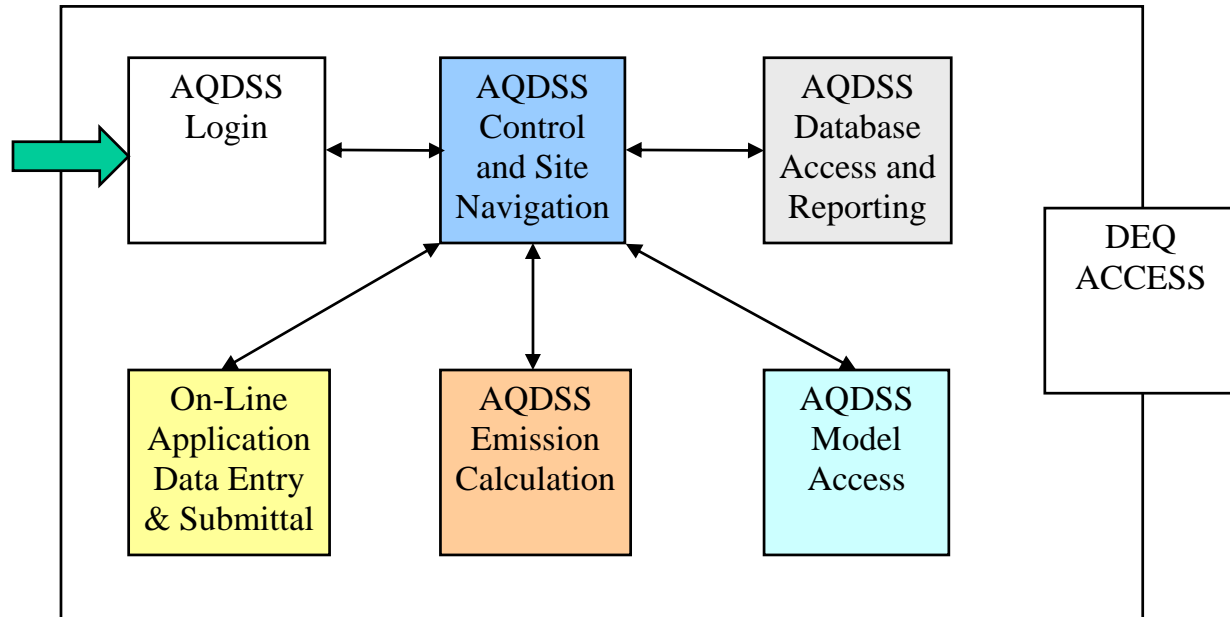

The current prototype has basic DSS functionality. However, the system does not provide emission calculation, sophisticated reporting, or permit generation. The AQDSS Should Allow AQ Permit Applicants to Submit an Application Online, and Facilitate Applicant Communication with the DEQ.

Access to the AQDDS

index - Microsoft Internet Explorer

File Edit View Favorites Tools Help

Back Forward Stop Home Search Favorites Media

Address <http://localhost/acdss/index.php> Go

Links Ioshida Access Customize Links Free Hotmail Keall-Mayer Windows Windows Media

 MONTANA Department of Environmental Quality

AIR QUALITY DECISION SUPPORT SYSTEM

USER NAME:

PASSWORD:

AIR & WAIST MANAGEMENT BUREAU



MIDEQ

Done Local intranet

AQDSS Site Navigation

The screenshot shows a web browser window titled "AQ Portable Permit Site Navigation - Microsoft Internet Explorer". The browser's address bar is empty, and the menu bar includes "File", "Edit", "View", "Favorites", "Tools", and "Help". The toolbar contains icons for Back, Forward, Stop, Home, Search, Favorites, Media, Print, and a user profile icon.

The main content area features a blue banner with the Montana Department of Environmental Quality logo and the text "MONTANA Department of Environmental Quality". Below the banner, the date and time "Sunday 2004-04-04 9:03" are displayed. The title "AIR QUALITY DECISION SUPPORT SYSTEM" is centered in a large, bold font. Below the title, the address "Air Resources Management Bureau, P.O. Box 200901, Helena, MT 59620-0901" and the phone number "Phone: 406-444-3490" are listed. A link for "Permitting Comments and Questions" is provided.

The "AIR QUALITY DSS SITE NAVIGATION" section contains a table of navigation options:

Start a New Air Quality Application for Portable Sources:	APPLY
Query the DSS Application Database:	QUERY
Screen3 Model Data Input:	MODEL
Application Edit / Review	APEDIT
Run Air Quality Decision Support System:	AQDSS

At the bottom, a "Return to DSS Home Page:" label is followed by a button labeled "AQDSS Home". A link for "Air Resources Management Bureau" and the department's logo are also present.

AQDSS Permit Application – Applicant Information

application_pg1 - Microsoft Internet Explorer

File Edit View Favorites Tools Help

Back Forward Stop Home Search Favorites Media Print Mail

[Permitting Comments and Questions](#)

MONTANA AIR QUALITY PERMIT APPLICATION FOR PORTABLE SOURCES

The application fee, the affidavit of publication for the required public notice, and the public notice, must be mailed to the above address. Instructions for filling out this form are contained in the Instructions and Suggested Format document available from the Department of Environmental Quality (department). Please contact the Air Resources Management Bureau if you have any questions regarding this permit application.

§ 1.0 GENERAL FACILITY INFORMATION AND SITE DESCRIPTION

Company Name:

Street:

City:

Zip:

Phone:

Contact Name:

Contact Location:

Contact Phone:

AQDSS Permit Application – Source Location

The screenshot shows a web browser window displaying the AQDSS Permit Application interface. The browser's address bar is empty, and the menu bar includes File, Edit, View, Favorites, Tools, and Help. The toolbar contains icons for Back, Forward, Stop, Home, Search, Favorites, Media, Print, and Help. The main content area features a banner for the Montana Department of Environmental Quality with a scenic background. Below the banner, the date and time are displayed as "Sunday 2004-04-04 13:27". The title "AIR QUALITY DECISION SUPPORT SYSTEM" is centered, followed by a link for "Permitting Comments and Questions". The section header "§ 2.0 GENERAL FACILITY INFORMATION AND SITE DESCRIPTION CONTINUED..." is followed by a form with the following fields:

Source Type:	Crusher
Source Location - Street:	P.O. Box 517
Source Location - City:	Columbia Falls
Source Location - Zip:	59912
Source Location - County:	Flathead
Source Location - Township:	30 N
Source Location - Range:	21 W
Source Location - Section:	21

A "Save" button is located below the form fields. At the bottom left, there is a "Return to DSS Home Page:" label and an "AQDSS Home" button. At the bottom center, there is a link for "Air Resources Management Bureau" and a logo for ARMB (Air Resources Management Bureau) featuring a stylized tree and the text "ARMB" and "Air Resources Management Bureau".

AQDSS Permit Application – Emission Inventory

The screenshot shows a web browser window displaying the AQDSS Permit Application Emission Inventory form. The browser's address bar is empty, and the menu bar includes File, Edit, View, Favorites, Tools, and Help. The toolbar contains icons for Back, Forward, Stop, Home, Search, Favorites, Media, Print, Mail, and a user profile icon. The main content area has a title "AIR QUALITY DECISION SUPPORT SYSTEM" and a link for "Permitting Comments and Questions". Below this is the section header "§ 3.0 EMISSION INVENTORY" and a instruction: "Enter the total emissions from all equipment. Emission Values should be in units of Tons Per Year (Tons/Year)." The form contains several input fields with the following labels and values: Units (1PY), Particulate Matter - PM (20.9), PM10 (Less Than or Equal To 10 Microns) (13.5), Sulfur Dioxide - SO2 (1.5), Nitrogen Oxides - NOX (94.7), Volatile Organic Hydrocarbons - VOC (6.9), Carbon Monoxide - CO (20.5), and Lead - Pb (0). A "Save" button is located below the Lead - Pb field. At the bottom left, there are two buttons: "AQDSS Home" and "AQDSS NAVIGATION". At the bottom center, there is a link for "Air Resources Management Bureau" and a logo for the Air Resources Management Bureau.

AIR QUALITY DECISION SUPPORT SYSTEM

[Permitting Comments and Questions](#)

§ 3.0 EMISSION INVENTORY

Enter the total emissions from all equipment. Emission Values should be in units of Tons Per Year (Tons/Year).

Units:

Particulate Matter - PM:

PM10 (Less Than or Equal To 10 Microns):

Sulfur Dioxide - SO2:

Nitrogen Oxides - NOX:

Volatile Organic Hydrocarbons - VOC:

Carbon Monoxide - CO:

Lead - Pb:

[Air Resources Management Bureau](#)



AQDSS Permit Application – Process Equipment

application_pg4 - Microsoft Internet Explorer

File Edit View Favorites Tools Help

Back Forward Stop Home Search Favorites Media Mail Print

Permitting Comments and Questions

§ 4.1 PROCESS EQUIPMENT - LISTING

Enter the requested information for each piece of equipment.

Equipment Name (Emitting Unit Identifier):	Generator
Make:	Cat
Model:	520 kw
Serial Number:	4444444
Date of Manufacture:	1980
Design Capacity:	520
Design Capacity Units:	KW
Average Process Rate:	500
Type of Material:	n/a
Fuel Type:	diesel
Fuel Burning Rate:	100
Fuel Burning Units:	lbs/h

Select 'Next' after all Equipment has been entered:

[Air Resources Management Bureau](#)

AQDSS Permit Application – Operating Schedule

Application_pgs/ Microsoft Internet Explorer

File Edit View Favorites Tools Help

Back Forward Stop Refresh Home Search Favorites Media Mail Print Print Preview

AIR QUALITY DECISION SUPPORT SYSTEM

[Permitting Comments and Questions](#)

§ 4.2 PROCESS EQUIPMENT - OPERATING SCHEDULE

Percent of the applicant's operation in each time frame. The percentages entered must add up to 100%

PAT - Percent Annual Throughput

PAT December - February:	<input type="text" value="10"/>
PAT March - May:	<input type="text" value="20"/>
PAT June - August:	<input type="text" value="50"/>
PAT September - November:	<input type="text" value="20"/>
Operating Hours Per Day:	<input type="text" value="12"/>
Operating Days Per Week:	<input type="text" value="6"/>
Operating Weeks Per Year:	<input type="text" value="52"/>
Operating Hours Per Year:	<input type="text" value="8760"/>

[Air Resources Management Bureau](#)



AQDSS Permit Application – Air Pollution Control Equipment

Application - p40 - Microsoft Internet Explorer

File Edit View Favorites Tools Help

Back Forward Stop Refresh Home Search Favorites Media Mail Print Send To Favorites

AIR QUALITY DECISION SUPPORT SYSTEM

[Permitting Comments and Questions](#)

§ 5.1 Air Pollution Control Equipment Information

APCE - Air Pollution Control Equipment

APCE Type:

APCE Make:

APCE Model:

APCE Serial Number:

Date of Manufacture:

Control Efficiency:

Cost:

[Air Resources Management Bureau](#)



AQDSS Permit Application – Stack Data

The screenshot shows a web browser window titled "Application - Microsoft Internet Explorer". The browser's address bar and menu bar are visible. The main content area displays the "AIR QUALITY DECISION SUPPORT SYSTEM" logo and a link for "Permitting Comments and Questions". Below this, the section is titled "§ 5.2 Air Pollution Control Equipment - Stack Data".

The form includes the following fields and a button:

- UTM - Universal Transverse Mercator
 - UTM Northing:
 - UTM Easting:
 - UTM Zone:
 - Elevation:
- Stack Type (Square, Round):
- Stack Height:
- Stack Diameter:
- Stack Units:
- Stack Temperature:
- Stack Temp. Units:
- Stack Gas Velocity:
- Stack Gas Velocity Units:
- Stack Flow Rate:
- Stack Flow Rate Units:

A "Save" button is located below the "Stack Flow Rate Units" field.

At the bottom left of the form, there are two buttons: "AQDSS Home" and "AQDSS NAVIGATION".

AQDSS Model Data Input

Application_pgo - Microsoft Internet Explorer

File Edit View Favorites Tools Help

Back Forward Stop Home Search Favorites Media

Source Type (Default - enter 'P'):	p
Emission Rate (Grams /Second):	1
Stack Height (Meters):	3
Stack Inside Diameter (Meters):	0.3
Stack Gas Exit Velocity (Meters/Second):	1
Stack Gas Exit Temperature (Kelvin):	350
Ambient Air Temp. in Kelvin (Default - enter '293'):	293
Receptor "Flagpole" Height Above Ground (Meters):	3
Urban / Rural Option (enter U or R):	r
Consider Building Downwash (enter Y or N):	r
Complex Terrain Screen above Stack Height (enter Y or N):	y
Simple Terrain Screen above Stack Base (enter Y or N):	y
Meteorology Choice (Default - enter 2):	2
Mel. Choice cont. - if 2 above, enter a value 1 through 6 (stability classes A through F (1=A, 2=B, ..., 6=F)):	4
Automated Distance Array (Default - enter 'Y'):	y
Terrain Height Above Stack Base (Meters):	0
Minimum Distance to Use (Meters):	500
Maximum Distance to Use (Meters):	1000
Continue Simple Terrain Automated Calcs. with New Terrain Height (Default - enter 'N'):	r
Use Discrete Distances (Default - enter 'N'):	r
Print: Hard Copy (Default - enter 'N'):	r

Save for Model Input

Run Screen3 Model

AQDSS Permit Application – Edit and Review

DSS Application Review / Edit - Microsoft Internet Explorer

File Edit View Favorites Tools Help

Back Forward Stop Refresh Home Search Favorites Media Print Mail New Tab

AIR QUALITY DECISION SUPPORT SYSTEM

[Permitting Comments and Questions](#)

AQDSS NAVIGATION

APPLICATION EDIT / REVIEW

Enter Application Number:

AppNo:

Owner_Name:

O_Street:

O_City:

O_Zip:

O_Phone:

Contact_Name:

C_Address:

C_Phone:

SiteNo:

AppNo: 0

AQDSS Database Query

The screenshot shows a web browser window titled "http://localhost/aqdss/free_query.php - Microsoft Internet Explorer". The browser's address bar and menu bar are visible. The main content area has a grey background and features the following elements:

- Header:** "AIR QUALITY DECISION SUPPORT SYSTEM" in large, bold, black letters.
- Link:** "[Permitting Comments and Questions](#)" in blue text.
- Text:** "Please Enter Your Query Below." centered on the page.
- Form:** A text input field containing the SQL query:

```
SELECT * FROM PERMIT_APPLICANT  
WHERE APPNO=1
```
- Buttons:** Two buttons below the form: "Submit the Query" and "Clear the Query".
- Navigation:** A button labeled "AQDSS" and a button labeled "AQDSS NAVIGATION".
- Footer:** "[Air Resources Management Bureau](#)" in blue text, followed by a logo of a plant growing from a blue arc, and "[Montana Department of Environmental Quality](#)" in blue text.

AQDSS Database Query

index - Microsoft Internet Explorer

File Edit View Favorites Tools Help

Back Search Favorites Media

MONTANA Department of Environmental Quality

AIR QUALITY DECISION SUPPORT SYSTEM

Free Query Results

[Permitting Comments and Questions](#)

Saving Your Query for Debugging Purposes
Your Query was: "SELECT * FROM PERMIT_APPLICANT WHERE APPNO=1"
Records Found: 1 rows

AppNo	Owner_Name	O_Street	O_City	O_Zip	O_Phone	Contact_Name	C_Address	C_Phone
1	Biff Winkle	Asphalt St.	Great Falls	59999	406	B. Winkle	Asphalt St	406

Back to Free Query

Back to DSS

Air Quality Decision Support

index - Microsoft Internet Explorer

File Edit View Favorites Tools Help

Back Forward Stop Home Search Favorites Media

AIR QUALITY DECISION SUPPORT SYSTEM

[Permitting Comments and Questions](#)

AQDSS NAVIGATION

Retrieve New (Fortables) Permit Applications:

There Are No New Permit Applications

Enter Permit Application Number:

Run SCREEN3 on Calculated Potential Emissions (Checked Box is Yes):

The SCREEN3 Model Will Not Be Run UNLESS the Box is Checked!

To Run the DSS on a Permit Application :

AQDSS Recommendation:

Generate AQDSS Permit Application Report (Check = Yes).

DSS- Action

The screenshot shows a web browser window titled "index - Microsoft Internet Explorer". The browser's address bar is empty, and the menu bar includes "File", "Edit", "View", "Favorites", "Tools", and "Help". The toolbar contains icons for Back, Forward, Stop, Home, Search, Favorites, Media, Print, Mail, and a user profile icon.

The main content area of the browser displays the "AIR QUALITY DECISION SUPPORT SYSTEM" header in a large, bold, serif font. Below the header is a blue hyperlink: [Permitting Comments and Questions](#).

Below the link is a horizontal line, followed by a button labeled "AQDSS NAVIGATION".

The next section contains the text "Retrieve New (Portables) Permit Applications" followed by a "Submit" button.

Below this is the text "There Are No New Permit Applications".

Further down is the text "Enter Permit Application Number:" followed by a text input field containing the number "1".

Below the input field is the text "Run SCREEN3 on Calculated Potential Emissions (Checked Ecx is Yes):" followed by an unchecked checkbox.

Below the checkbox is the text "The SCREEN3 Model Will Not Be Run UNLESS the Ecx is Checked".

Below this is the text "To Run the DSS on a Permit Application:" followed by a "Submit" button.

Below the button is the text "AQDSS Recommendation:".

Below that is the text "Application Incomplete".

At the bottom of the main content area is the text "Generate AQDSS Permit Application Report (Check = Yes):" followed by an unchecked checkbox.

Below the main content area is a horizontal line, followed by two buttons: "AQDSS Home" and "Start Application".

Alternative DSS Database Tools

phpMyAdmin

PhpMyAdmin allows DEQ staff to perform database maintenance, generate reports, add and delete information, as well as export data files.

The screenshot shows the phpMyAdmin interface in a Microsoft Internet Explorer browser window. The title bar reads "aqdss running on localhost - phpMyAdmin 2.4.0-rc2 - Microsoft Internet Explorer". The address bar shows "http://localhost/phpmyadmin/index.php". The main content area displays the "Database aqdss running on localhost" structure. A table lists 11 tables, each with 1 record and a size of 16.0 KB. The tables are: air_pol_control_equip, apce_stack, app_detail_status, aqdss_users, emissionfactor, emissions, eu_fuel, operating_sched, permit_applicant, process_equipment, and source_location. Below the table, there are links for "Check All / Uncheck All" and "With selected:". At the bottom, there are links for "Print view", "Data Dictionary", and "Create new table on database aqdss".

Table	Action	Records	Type	Size
<input type="checkbox"/> air_pol_control_equip	Browse Select Insert Properties Drop Empty	1	InnoDB	16.0 KB
<input type="checkbox"/> apce_stack	Browse Select Insert Properties Drop Empty	1	InnoDB	16.0 KB
<input type="checkbox"/> app_detail_status	Browse Select Insert Properties Drop Empty	1	InnoDB	16.0 KB
<input type="checkbox"/> aqdss_users	Browse Select Insert Properties Drop Empty	1	InnoDB	16.0 KB
<input type="checkbox"/> emissionfactor	Browse Select Insert Properties Drop Empty	1	InnoDB	16.0 KB
<input type="checkbox"/> emissions	Browse Select Insert Properties Drop Empty	1	InnoDB	16.0 KB
<input type="checkbox"/> eu_fuel	Browse Select Insert Properties Drop Empty	1	InnoDB	16.0 KB
<input type="checkbox"/> operating_sched	Browse Select Insert Properties Drop Empty	1	InnoDB	16.0 KB
<input type="checkbox"/> permit_applicant	Browse Select Insert Properties Drop Empty	1	InnoDB	16.0 KB
<input type="checkbox"/> process_equipment	Browse Select Insert Properties Drop Empty	1	InnoDB	16.0 KB
<input type="checkbox"/> source_location	Browse Select Insert Properties Drop Empty	1	InnoDB	16.0 KB
11 table(s)	Sum	11	-	176.0 KB

Check All / Uncheck All With selected: ▾

- [Print view](#)
- [Data Dictionary](#)
- [Create new table on database aqdss :](#)

Conclusions

Lesson's Learned

Happily, I have found that a novice can construct of a system such as presented in this report with some reasonable planning and some basic tools. It can even be fun with the right tools. PHP is a very powerful and flexible tool, and has sustained continued growth, ever increasing popularity, and even more sophistication (see <http://pear.php.net>). It is not unreasonable to assume that PHP will continue to be in our future.

Originally DSS screens were constructed based upon my understanding of the Decision Makers Needs. A more appropriate approach would have been a formalized development of requirements. Also, attempting to construct an emission calculation screen has been time consuming. Realistically, the amount of time necessary to fully complete the DSS with this capability, and resolve any bugs, will be nearly equivalent to the time already invested.

Features

Features to Add

- The AQDSS should have the ability to generate an 'Application Status' to an applicant, or a decision maker permit;
- The AQDSS should have the ability to function on more types of AQ source categories;
- The AQDSS should have the ability to generate permit requirements (Emission Limits; Operating, Reporting, and Testing Requirements) for inclusion in AQ Permits (PERMIT GENERATION);
- The AQDSS should have the ability to maintain emission data, generate canned reports;
- The AQDSS should have the ability to run more than one type of AQ dispersion model;
- The AQDSS should allow applicants to pay fees on-line.

Problems Encountered

With the sophistication and power of PHP, it truly does require an effort by the developer to acquire the necessary skills to become a proficient user of PHP...it helps that PHP resembles C. I have wished for a PHP compiler more than once. Macromedia's Dreamweaver tool is very handy for some tasks, however it is incomplete with respect to PHP.

The older air quality models have been written, and maintained, in Fortran. You must have access to a suitable Fortran compiler for the Windows environment, or you must use Linux. My original goal was to convert the most basic Screen III model to Java, which would provide an opportunity to develop a GUI for the model. Unfortunately that isn't an appropriate action with a regulatory model. For a modeled result to have value, it must originate from an EPA approved air quality model. Therefore efforts to update the model were temporarily discontinued in the fall of 2003.

The emission calculation component of this project has resisted completion. To develop methodology general enough for multiple source categories has extended the time necessary to complete. This capability, when completed, shall simplify dramatically any following development efforts to expand the DSS beyond its current scope.

Finally, during the course of this small project, the intended recipients of the system have experienced an organizational restructuring that complicates the process. Similarly, the technical staff that are intended to implement the system have gone through considerable staffing changes. The consequences of these changes impacted the progress on more than one occasion.

Final Observations

This project, while simple, offered insights into the substantial growth of Apache, PHP, and MySQL. These open-source tools have become dramatic success in the burgeoning internet market. Why? They are simple, fast, and cost effective. Another significant point is that these tools allow sophisticated use of the internet for much more than commerce.

I would not hesitate to use these technologies again, but I would also investigate and use competing tools such as Java and .Net based technologies. Specifically, for development efforts of significant size and scope, the Java and .Net technologies would seem to offer advantages. The ability to comprehensively test, the large code base, and the security advantages of these alternative tools would make them likely candidates for demanding environments.

Bibliography & Resources

References

Fundamentals of Database Systems, Third Edition; Ramez Elmasri, Shamkant B. Navathe; © 2000 Elmasri and Navathe; Addison-Wesley; ISBN 0-8053-1755-4.

MySQL; Paul DuBois; © 2000 New Riders Publishing; ISBN 0-7357-0921-1.

PHP Essentials; Julie Meloni; © 2000 Prima Publishing; ISBN 0-7615-2729-X.

PHP Functions, Essential Reference; Zak Greant, Graeme Merral, Torben Wilson, Brett Michlitsch; © 2002 New Riders Publishing; ISBN 0-7357-0970-X

PHP and MySQL Web Development, Second Edition; Luke Welling and Laura Thomson; © 2003 Sams Publishing; ISBN 0-672-32525-X.

SQL Fundamentals, Second Edition; John J. Patrick; © 2002 Prentice Hall PTR; ISBN 0-13-066947-4.

Workbook of Atmospheric Dispersion Estimates, Second Edition; D. Bruce Turner; © 1994 CRC Press; 1-56670-023-X.

Links

Apache HTTP Server: <http://www.apache.org/>

PHP Server Scripting Language: <http://www.php.net/>

PHP Manual: <http://www.phpbuilder.com/manual/>

PHPMyAdmin (Web-based MySQL Interface): <http://www.phpmyadmin.net>

PEAR (PHP Extension & Application Repository): <http://pear.php.net/>

MySQL Database: <http://www.mysql.com/>

MySQL DB Control Center (Admin. Interface): <http://www.mysql.com/downloads/mysqlcc.html>

Linux: <http://www.tldp.org/>

GNU: <http://www.gnu.org>

W3C: <http://www.w3.org/>

HTTP Examples: <http://www.w3schools.com/html/>

Air Quality Links

EPA Air Programs: <http://www.epa.gov/ebtpages/air.html>

EPA Dispersion Models: <http://www.epa.gov/scram001/tt22.htm#rec>

Air Resources Management Bureau: <http://www.deq.state.mt.us/pcd/awm/air/index.asp>

Dept. Environmental Quality: <http://www.deq.state.mt.us/index.asp>

Air Monitoring and Modeling: <http://www.deq.state.mt.us/ppa/mdm/air/index.asp>

Glossary

The majority of definitions pertaining to air quality and the dispersion model have been provided in the body of the document, however additional definitions pertaining to the model are provided in the appendix, which includes a portion of the manual for the SCREEN3 model. Air quality or permitting acronyms used throughout the document are defined where they are first introduced. Additional clarification for several relevant terms are provided below.

Air Pollution Control Equipment	Equipment that collects emissions from process equipment and removes one or more pollutants. Typical devices used with portable sources are 'Baghouses' and 'Scrubbers'.
Ambient Air	Outside Air; Not Indoor Air.
Decision Support System	System comprised of a database, model, and a graphical user interface.
Dispersion Model	Ambient Air Quality Model that predicts the highest concentration of pollutants from sources of air pollution at locations (receptor points) removed from the source.
Emissions	Air pollution, or air contaminants, resulting from the operation of process equipment.
Emission Factor	A value unique to a type of processing equipment, process, or fuel that may be used to estimate potential emissions from the operation of process equipment and portable sources.
Meteorological Data	Weather data typically acquired from a meteorological station which records temperature, wind speed, wind direction, and other pertinent information. Data used by dispersion models to predict ambient air impacts from portable sources and their process equipment.
Permit	A document issued to a portable source from a regulatory agency identifying acceptable practices and specific requirements to protect air quality while the source operates.
Pollutant	A specific type of emission constituent, typically Particulate Matter, Fine Particulate Matter, Oxides of Nitrogen, Oxides of Sulfur, Carbon Monoxide, Carbon Dioxide, or Lead.
Portable Sources	A type of source that moves from one location of operation to another location of operation dependant on the source of aggregate and the particular job. For this application portable sources refer to Crushing and Screening Plants, Asphalt Plants, and Concrete Batch Plants.
Potential Emissions	Emissions Estimated by using process rate data, the hours of operation, fuel type, air pollution control type, emission limits, existing source testing (stack testing) data, or other published data.
Process Equipment	Equipment used to crush, screen, convey, or process aggregate, produce asphalt, produce concrete, or generate

	power at a portable source of air pollution.
Receptor Point	A location, usually a specific coordinate or distance from the source of emissions, where the dispersion model estimates the concentration of pollution. The estimated concentration is compared to ambient air quality standards to assure that human health and welfare is protected.
Stack	An exhaust flue that process equipment or pollution control equipment uses to discharge the air pollutants (emissions).

Appendices

Selected PHP Scripts / HTML Forms

```
<?php
/*****
* Name: Jack Dartman
* Assign: AQDSS
* Date: 2003
* Program: DSS Application
* Description: FileName="Connection_php_mysql.htm"
*****/
#FileName="Connection_php_mysql.htm"
# Type="MYSQL"
# HTTP="true"
$hostname_aqdss_connect = "*****";
$databse_aqdss_connect = "aqdss";
$username_aqdss_connect = "*****";
$password_aqdss_connect = "*****";
$aqdss_connect = mysql_pconnect($hostname_aqdss_connect, $username_aqdss_connect,
$password_aqdss_connect) or die(mysql_error());
?>
```

```

<?php require_once('Connections/aqdss_connect.php'); ?>
<?php
/*****
* Name: Jack Dartman
* Assign: AQDSS
* Date: 2003
* Program: DSS Application
* Description: Free Text Query of DSS Database
*****/
mysql_select_db($database_aqdss_connect, $aqdss_connect);
?>

<body bgcolor="#CCCCCC" text="#000000" link="#0000FF" vlink="#6699FF"
alink="#FFFFFF">
<p align="center"></p>

<p align="center">
<!-- #BeginDate format:fIS1m -->Saturday 2004-04-03 17:36<!-- #EndDate -->
</p>
<h2 align="center">AIR QUALITY DECISION SUPPORT SYSTEM</h2>
<span style='font-family:"Arial Narrow";'>
<div align="center"><a href="mailto:dklemp@state.mt.us">Permitting Comments and
Questions</a> </div>
</span>
<hr><span style='font-family:"Arial Narrow";'>
<p align="center"><font color="#000000">Please Enter Your Query Below.</font></p>
<DIV align="center">
<form method="post" action="free_result.php">
<textarea type="TEXT" name="textarea" cols=60 rows="8"></textarea><BR><BR>
<input type="submit" name="submit" value="Submit the Query">
&nbsp;
&nbsp;
<input type="reset" name="reset" value="Clear the Query">
</form>
</DIV></span>
<hr>
<form align="left" name="form2" method="post" action="dss_nav.php">
<input type="submit" name="Submit" value="AQDSS">
</form>
<form name="form3" method="post" action="site_nav.php">
<input type="submit" name="Submit3" value="AQDSS NAVIGATION">
</form>

<p align="center"><a href="http://www.deq.state.mt.us/pcd/arm/index.asp" title="ARMB">Air
Resources Management Bureau</a></p>

```



```

<p align="center"><a href="/aqdss.php"></a></p>
<p align="center"><a href="http://www.deq.state.mt.us/" title="MTDEQ">Montana
Department of Environmental Quality</a> </p>
<p>&nbsp;</p>
</p>
</body>
</html>

```

+++++

```

<?php require_once('Connections/aqdss_connect.php'); ?>
<?php
/*****
* Name: Jack Dartman
* Assign: AQDSS
* Date: 2003
* Program: DSS Application
* Description: Free Result - Query of DSS Database
*****/
mysql_select_db($database_aqdss_connect, $aqdss_connect);
?>
<html>
<head>
<title>index</title>
<meta http-equiv="Content-Type" content="text/html; charset=iso-8859-1">
</head>

<body bgcolor="#CCCCCC" text="#000000" link="#0000FF" vlink="#6699FF"
alink="#FFFFFF">
<p align="center"></p>
<p>&nbsp;</p>
<h1 align="center">AIR QUALITY DECISION SUPPORT SYSTEM</h1>
<h2 align="center" >Free Query Results</h2>
<div align="center"><a href="mailto:dklemp@state.mt.us">Permitting Comments and
Questions</a> </div>
<hr>
<p>&nbsp;</p>
<?PHP
    $qstring = stripslashes($HTTP_POST_VARS["textarea"]);
    echo("Saving Your Query for Debugging Purposes<BR>\n");
    echo("Your Query was: <B>\\"$qstring\"</B><BR>\n");
    mysql_select_db($database_aqdss_connect, $aqdss_connect);
    $result = mysql_query($qstring, $aqdss_connect);
    if($result)
    {

```

```

        $nrows = mysql_num_rows($result);
        $nfields = mysql_num_fields($result);
    }
    printf("Records Found: <B>%d rows</B>\n", $nrows);
    if(!$result)
    {
        echo("There May be a Mistake in Your SQL Query, Try Again<BR>\n");
    }
?>
<BR>
<BR>
<TABLE BORDER align="center">
  <?PHP
    if($result)
    {
        echo("\n<TR BGCOLOR=\"white\">");
        for($i = 0; $i < $nfields; $i ++ )
        {
            $fname = mysql_fieldname($result, $i);
            echo("<TH>$fname</TH>");
        }
        echo("</TR>");
        $color = "#CCCCCC";
        for($i = 0; $i < $nrows; $i ++ )
        {
            if(($i % 2) == 0)
            {
                echo("\n<TR>");
            }
            else
            {
                echo("\n<TR BGCOLOR = $color>");
            }
            $rowarr = mysql_fetch_row($result);
            for($j = 0; $j < $nfields; $j ++ )
            {
                $val = $rowarr[$j];
                if($val == "")
                {
                    $val = "&nbsp;";
                }
                echo("<TD>$val</TD>");
            }
            echo("</TR>");
        }
    }
  }

```

```

        if($result)
        {
            mysql_free_result($result);
        }
    ?>
</TABLE>
<p>&nbsp;</p>
<form align="left" name="index" method="post" action="free_query.php">
  <input type="submit" name="index" value="Back to Free Query">
</form>
<form align="left" name="form2" method="post" action="dss_nav.php">
  <input type="submit" name="Submit" value="Back to DSS">
</form>
<p>&nbsp;</p>
<p align="center"><a href="http://www.deq.state.mt.us/pcd/arm/index.asp" title="ARMB">Air
  Resources Management Bureau</a></p>
<p align="center"><a href="/aqdss.php"></a></p>
<p align="center"><a href="http://www.deq.state.mt.us/" title="MTDEQ">Montana
  Department of Environmental Quality</a> </p>
<p>&nbsp;</p>
</body>
</html>

```

```

<?php require_once('Connections/aqdss_connect.php'); ?>
<!--*****-->
* Name: Jack Dartman
* Assign: AQDSS
* Date: 2003
* Program: DSS Application
* Description: DSS Navigation Page
*****-->
<html>
<head>
<title>AQ Portable Permit Site Navigation</title>
<meta http-equiv="Content-Type" content="text/html; charset=iso-8859-1">
</head>
<body bgcolor="#CCCCCC" text="#000000" link="#0000FF" vlink="#6699FF"
alink="#FFFFFF">
<p align="center"></p>
<p align="center">
<!-- #BeginDate format:fIS1m -->Sunday 2004-04-04 9:03<!-- #EndDate -->
</p>
<h2 align="center">AIR QUALITY DECISION SUPPORT SYSTEM</h2>
<hr>
<span style='font-family:"Arial Narrow";'>
<h4 align="center">Air Resources Management Bureau, P.O. Box 200901, Helena, MT 59620-
0901</h4>
<h4 align="center">Phone: 406-444-3490</h4></span>
<span style='font-family:"Arial Narrow";'>
<div align="center"><a href="mailto:dklemp@state.mt.us">Permitting Comments and
Questions</a> </div></span>
<hr>
<p align="center"><b><span style='font-family:"Arial Narrow";'> AIR QUALITY DSS
SITE NAVIGATION</span></b></p>
<!-- Navigation Table -->
<div align="center">
<table width="75%" border="1">
<tr> <form name="form3" method="post" action="application_pg1.php">
<td><div align="center">Start a New Air Quality Application for Portable
Sources:</div></td>
<td> <div align="center">
<input type="submit" name="Submit4" value="APPLY ">
</div></td>
</form></tr>
<tr> <form name="form3" method="post" action="free_query.php">
<td><div align="center">Query the DSS Application Database: </div></td>
<td> <div align="center">
<input type="submit" name="Submit3" value="QUERY">

```

```

        </div></td>
</form></tr>
<tr> <form name="form3" method="post" action="application_pg8.php">
    <td><div align="center">Screen3 Model Data Input:</div></td>
    <td> <div align="center">
        <input type="submit" name="Submit3" value="MODEL">
    </div></td>
</form></tr>
<tr> <form name="form3" method="post" action="app_review.php">
    <td><div align="center">Application Edit / Review</div></td>
    <td> <div align="center">
        <input type="submit" name="Submit4" value="APEDIT">
    </div></td>
</form></tr>
<tr> <form name="form3" method="post" action="dss_nav.php">
    <td><div align="center">Run Air Quality Decision Support System:</div></td>
    <td> <div align="center">
        <input type="submit" name="Submit3" value="AQDSS">
    </div></td>
</form></tr>
<!--<tr>
    <td>&nbsp;</td>
    <td>&nbsp;</td>
</tr -->
</table>
</div>
<p><span style='font-family:"Arial Narrow";'>
<p>&nbsp;</p>
<hr>
    <form name="form3" method="post" action="index.php">
Return to DSS Home Page: <input type="submit" name="Submit4" value="AQDSS Home">
</form>
<p align="center"><a href="http://www.deq.state.mt.us/pcd/arm/index.asp" title="ARMB">Air
Resources Management Bureau</a></p>
<p align="center"><a href="/aqdss.php"></a></p>
<p align="center"><a href="http://www.deq.state.mt.us/" title="MTDEQ">Montana
Department of Environmental Quality</a> </p>
<p>&nbsp;</p>
<p>&nbsp;</p>
<p align="center">&nbsp;</p>
    <p>&nbsp;</p>
<p>&nbsp;</p>
<p align="center">&nbsp;</p>
<p align="center"></p>
</span></p></body></html>

```

```

<?php require_once('Connections/aqdss_connect.php'); ?>
<?php
/*****
* Name: Jack Dartman
* Assign: AQDSS
* Date: 2003
* Program: DSS Application
* Description: This script is for manipulating AQDSS.
*****/

function GetSQLValueString($theValue, $theType, $theDefinedValue = "",
$theNotDefinedValue = "")
{
    $theValue = (!get_magic_quotes_gpc()) ? addslashes($theValue) : $theValue;

    switch ($theType) {
        case "text":
            $theValue = ($theValue != "") ? "'" . $theValue . "'" : "NULL";
            break;
        case "long":
        case "int":
            $theValue = ($theValue != "") ? intval($theValue) : "NULL";
            break;
        case "double":
            $theValue = ($theValue != "") ? "'" . doubleval($theValue) . "'" : "NULL";
            break;
        case "date":
            $theValue = ($theValue != "") ? "'" . $theValue . "'" : "NULL";
            break;
        case "defined":
            $theValue = ($theValue != "") ? $theDefinedValue : $theNotDefinedValue;
            break;
    }
    return $theValue;
}

$editFormAction = $HTTP_SERVER_VARS['PHP_SELF'];
if (isset($HTTP_SERVER_VARS['QUERY_STRING'])) {
    $editFormAction .= "?" . $HTTP_SERVER_VARS['QUERY_STRING'];
}

if ((isset($HTTP_POST_VARS["MM_insert"])) && ($HTTP_POST_VARS["MM_insert"] ==
"form1")) {

```

```
$insertSQL = sprintf("INSERT INTO permit_applicant (Owner_Name, O_Street, O_City,
O_Zip, O_Phone, Contact_Name, C_Address, C_Phone) VALUES (%s, %s, %s, %s, %s, %s,
%s, %s)",
```

```
    GetSQLValueString($HTTP_POST_VARS['Owner_Name'], "text"),
    GetSQLValueString($HTTP_POST_VARS['O_Street'], "text"),
    GetSQLValueString($HTTP_POST_VARS['O_City'], "text"),
    GetSQLValueString($HTTP_POST_VARS['O_Zip'], "text"),
    GetSQLValueString($HTTP_POST_VARS['O_Phone'], "text"),
    GetSQLValueString($HTTP_POST_VARS['Contact_Name'], "text"),
    GetSQLValueString($HTTP_POST_VARS['C_Address'], "text"),
    GetSQLValueString($HTTP_POST_VARS['C_Phone'], "text"));
```

```
mysql_select_db($database_aqdss_connect, $aqdss_connect);
$result1 = mysql_query($insertSQL, $aqdss_connect) or die(mysql_error());
```

```
$insertGoTo = "application_pg2.php";
if (isset($HTTP_SERVER_VARS['QUERY_STRING'])) {
    $insertGoTo .= (strpos($insertGoTo, '?')) ? "&" : "?";
    $insertGoTo .= $HTTP_SERVER_VARS['QUERY_STRING'];
}
header(sprintf("Location: %s", $insertGoTo));
}
?>
```

```
<html>
<head>
<title>application_pg1</title>
<meta http-equiv="Content-Type" content="text/html; charset=iso-8859-1">

</head>
```

```
<body bgcolor="#CCCCCC" text="#000000" link="#0000FF" vlink="#6699FF"
alink="#FFFFFF">
<p align="center"></p>
```

```
<p align="center">
<!-- #BeginDate format:fIS1m -->Saturday 2004-04-03 17:18<!-- #EndDate -->
</p>
<h2 align="center">AIR QUALITY DECISION SUPPORT SYSTEM</h2>
<hr>
<span style='font-family:"Arial Narrow";'>
<h4 align="center">Air Resources Management Bureau, P.O. Box 200901, Helena, MT 59620-
0901</h4>
<h4 align="center">Phone: 406-444-3490</h4></span>
<span style='font-family:"Arial Narrow";'>
<div align="center"><a href="mailto:dklemp@state.mt.us">Permitting Comments and
```

Questions

MONTANA AIR QUALITY PERMIT APPLICATION FOR PORTABLE SOURCES

The application fee, the affidavit of publication for the required public notice, and the public notice, must be mailed to the above address. Instructions for filling out this form are contained in the Instructions and Suggested Format document available from the Department of Environmental Quality (department). Please contact the Air Resources Management Bureau if you have any questions regarding this permit application.

§ 1.0 GENERAL FACILITY INFORMATION AND SITE DESCRIPTION

Form Action:

Company Name:	<input name="Owner_Name" size="32" type="text" value=""/>
Street:	<input name="O_Street" size="32" type="text" value=""/>
City:	<input name="O_City" size="32" type="text" value=""/>
Zip:	<input name="O_Zip" size="32" type="text" value=""/>
Phone:	<input name="O_Phone" size="32" type="text" value=""/>
Contact Name:	<input name="Contact_Name" size="32" type="text" value=""/>

```

    <td nowrap align="right">Contact Location:</td>
    <td><input type="text" name="C_Address" value="" size="32"></td>
</tr>
<tr valign="baseline">
    <td nowrap align="right">Contact Phone:</td>
    <td><input type="text" name="C_Phone" value="" size="32"></td>
</tr>
<tr valign="baseline">
    <td nowrap align="right">&nbsp;</td>
    <td><input type="submit" value=" Save " ></td>
</tr>
</table>
<input type="hidden" name="MM_insert" value="form1">
</form>
</span>
<p>&nbsp;</p>
<hr><span style='font-family:"Arial Narrow";'>
<form name="form3" method="post" action="index.php">
    <input type="submit" name="Submit4" value="AQDSS Home">
</form>
<form name="form3" method="post" action="site_nav.php">
    <input type="submit" name="Submit3" value="AQDSS NAVIGATION">
</form>
<p align="center"><a href="http://www.deq.state.mt.us/pcd/arm/index.asp" title="ARMB">Air
Resources Management Bureau</a></p>
<p align="center"><a href="/aqdss.php"></a></p>
</span>
</body>
</html>

```

```
<?php
```

```
/******  
* Name: Jack Dartman  
* Assign: AQDSS  
* Date: 2003  
* Program: MySqlConnection  
* Description: This script is for connecting to MySQL  
Portions of this script were copied from  
existing scripts that were performing the same function.  
*****/
```

```
class MySqlConnection
```

```
{
```

```
    var $isOpen;  
    var $hostname;  
    var $database;  
    var $username;  
    var $password;  
    var $timeout;  
    var $connectionId;
```

```
function MySqlConnection($ConnectionString, $Timeout, $Host, $DB, $UID, $Pwd)
```

```
{
```

```
    $this->isOpen = false;  
    $this->timeout = $Timeout;  
  
    if( $Host ) {  
        $this->hostname = $Host;  
    }  
    elseif( ereg("host=(^[^;]+);", $ConnectionString, $ret) ) {  
        $this->hostname = $ret[1];  
    }  
  
    if( $DB ) {  
        $this->database = $DB;  
    }  
    elseif( ereg("db=(^[^;]+);", $ConnectionString, $ret) ) {  
        $this->database = $ret[1];  
    }  
  
    if( $UID ) {  
        $this->username = $UID;  
    }  
    elseif( ereg("uid=(^[^;]+);", $ConnectionString, $ret) ) {
```

```

        $this->username = $ret[1];
    }

    if( $Pwd ) {
        $this->password = $Pwd;
    }
    elseif( ereg("pwd=(^[^;]+);", $ConnectionString, $ret) ) {
        $this->password = $ret[1];
    }
}

function Open()
{
    // if ($this->connectionId = mysql_connect($this->hostname, $this->username,
    $this->password) or die(mysql_error()))
    if ($this->connectionId = mysql_connect($this->hostname, $this->username, $this-
    >password))
    {
        $this->isOpen = ($this->database == "") ? true : mysql_select_db($this-
    >database, $this->connectionId);
    }
    else
    {
        // this error information gets added in test open

        // $error_message = mysql_error() ;

        // if ( $error_message == "" ){
        //     $error_message = "Unable to Establish Connection to " .
    $this->hostname . " for user " . $this->username ;
        //}

        // echo("<ERRORS><ERROR><DESCRIPTION>" . $error_message .
    "</DESCRIPTION></ERROR></ERRORS>");

        // $this->isOpen = false;
    }

}

function TestOpen()
{
    return ($this->isOpen) ? "<TEST status=true></TEST>" : $this-
    >HandleException();
}

```

```

function Close()
{
    if ($this->connectionId && $this->isOpen)
    {
        if (mysql_close($this->connectionId))
        {
            $this->isOpen = false;
            $this->connectionId = 0;
        }
    }
}

function GetTables()
{
    $xmlOutput = "";
    $result = mysql_list_tables($this->database, $this->connectionId);

    if ($result)
    {
        $xmlOutput = "<RESULTSET><FIELDS>";

        // Columns are referenced by index, so Schema and
        // Catalog must be specified even though they are not supported
        $xmlOutput .=
"<FIELD><NAME>TABLE_CATALOG</NAME></FIELD>";           // column 0 (zero-
based)
        $xmlOutput .=
"<FIELD><NAME>TABLE_SCHEMA</NAME></FIELD>";           // column 1
        $xmlOutput .=
"<FIELD><NAME>TABLE_NAME</NAME></FIELD>";           // column 2

        $xmlOutput .= "</FIELDS><ROWS>";
        $tableCount = mysql_num_rows($result);

        for ($i=0; $i < $tableCount; $i++)
        {
            $xmlOutput .= "<ROW><VALUE/><VALUE/><VALUE>";
            $xmlOutput .= mysql_tablename ($result, $i);
            $xmlOutput .= "</VALUE></ROW>";
        }

        $xmlOutput .= "</ROWS></RESULTSET>";
    }

    return $xmlOutput;
}

```

```

    }

    function GetViews()
    {
        // not supported
        return
"<RESULTSET><FIELDS></FIELDS><ROWS></ROWS></RESULTSET>";
    }

    function GetProcedures()
    {
        // not supported
        return
"<RESULTSET><FIELDS></FIELDS><ROWS></ROWS></RESULTSET>";
    }

    function GetColumnsOfTable($TableName)
    {
        $xmlOutput = "";
        $query = "DESCRIBE $TableName";
        // $result = mysql_query($query) or die("Invalid query: $query");
        $result = mysql_query($query) or die("<ERRORS><ERROR Identification=\" .
mysql_errno() .
        "\><DESCRIPTION>" . mysql_errno() . " " . mysql_error() .
"</DESCRIPTION><ERROR></ERRORS>");

        if ($result)
        {
            $xmlOutput = "<RESULTSET><FIELDS>";

            // Columns are referenced by index, so Schema and
            // Catalog must be specified even though they are not supported
            $xmlOutput .=
"<FIELD><NAME>TABLE_CATALOG</NAME></FIELD>";           // column 0 (zero-
based)
            $xmlOutput .=
"<FIELD><NAME>TABLE_SCHEMA</NAME></FIELD>";           // column 1
            $xmlOutput .=
"<FIELD><NAME>TABLE_NAME</NAME></FIELD>";             // column 2
            $xmlOutput .=
"<FIELD><NAME>COLUMN_NAME</NAME></FIELD>";
            $xmlOutput .= "<FIELD><NAME>DATA_TYPE</NAME></FIELD>";
            $xmlOutput .=
"<FIELD><NAME>IS_NULLABLE</NAME></FIELD>";

```

```

        $xmlOutput .=
"<FIELD><NAME>COLUMN_SIZE</NAME></FIELD>";

        $xmlOutput .= "</FIELDS><ROWS>";

// The fields returned from DESCRIBE are: Field, Type, Null, Key,
Default, Extra
while ($row = mysql_fetch_array($result, MYSQL_ASSOC))
{
    $xmlOutput .= "<ROW><VALUE/><VALUE/><VALUE/>";

    // Separate type from size. Format is: type(size)
    if (ereg("(.*?)\((.*)\)", $row["Type"], $ret))
    {
        $type = $ret[1];
        $size = $ret[2];
    }
    else
    {
        $type = $row["Type"];
        $size = "";
    }

    // MySQL sets nullable to "YES" or "", so we need to set "NO"
    $null = $row["Null"];
    if ($null == "")
        $null = "NO";

    $xmlOutput .= "<VALUE>" . $row["Field"] . "</VALUE>";
    $xmlOutput .= "<VALUE>" . $type . "</VALUE>";
    $xmlOutput .= "<VALUE>" . $null . "</VALUE>";
    $xmlOutput .= "<VALUE>" . $size . "</VALUE></ROW>";
}
mysql_free_result($result);

$xmlOutput .= "</ROWS></RESULTSET>";
}

return $xmlOutput;
}

function GetParametersOfProcedure($ProcedureName, $SchemaName, $CatalogName)
{
    // not supported
    return
"<RESULTSET><FIELDS></FIELDS><ROWS></ROWS></RESULTSET>";
}

```

```

}

function ExecuteSQL($aStatement, $MaxRows)
{
    if ( get_magic_quotes_gpc() )
    {
        $aStatement = stripslashes( $aStatement ) ;
    }

    $xmlOutput = "";
    // $result = mysql_query($aStatement) or die("Invalid query: $aStatement");
    // the error must be in the correct XML format to get picked up by the Error parser
in DW
    // added by DRN 1-29-02.
    $result = mysql_query($aStatement) or die("<ERRORS><ERROR
Identification=\"\" . mysql_errno() .
        \"><DESCRIPTION>\" . mysql_errno() . \" \" . mysql_error() .
\"</DESCRIPTION></ERROR></ERRORS>");

    if ($result)
    {
        $xmlOutput = "<RESULTSET><FIELDS>";

        $fieldCount = mysql_num_fields($result);
        for ($i=0; $i < $fieldCount; $i++)
        {
            $meta = mysql_fetch_field($result);
            if ($meta)
            {
                $xmlOutput .= "<FIELD";
                $xmlOutput .= " type=\"\" . $meta->type;
                $xmlOutput .= "\" max_length=\"\" . $meta->max_length;
                $xmlOutput .= "\" table=\"\" . $meta->table;
                $xmlOutput .= "\" not_null=\"\" . $meta-
>not_null;
                $xmlOutput .= "\" numeric=\"\" . $meta-
>numeric;
                $xmlOutput .= "\" unsigned=\"\" . $meta-
>unsigned;
                $xmlOutput .= "\" zerofill=\"\" . $meta-
>zerofill;
                $xmlOutput .= "\" primary_key=\"\" . $meta->primary_key;
                $xmlOutput .= "\" multiple_key=\"\" . $meta-
>multiple_key;
                $xmlOutput .= "\" unique_key=\"\" . $meta->unique_key;

```

```

        $xmlOutput .= "\"><NAME>"
$meta->name;
        $xmlOutput .= "</NAME></FIELD>";
    }
}

$xmlOutput .= "</FIELDS><ROWS>";
$row = mysql_fetch_assoc($result);

for ($i=0; $row && ($i < $MaxRows); $i++)
{
    $xmlOutput .= "<ROW>";

    foreach ($row as $key => $value) /* what is $key???? */
    {
        $xmlOutput .= "<VALUE>";
        $xmlOutput .= htmlspecialchars($value);
        $xmlOutput .= "</VALUE>";
    }

    $xmlOutput .= "</ROW>";
    $row = mysql_fetch_assoc($result);
}

mysql_free_result($result);

$xmlOutput .= "</ROWS></RESULTSET>";
}

return $xmlOutput;
}

function GetProviderTypes()
{
    // not supported?
    return
"<RESULTSET><FIELDS></FIELDS><ROWS></ROWS></RESULTSET>";
}

function ExecuteSP($aProcStatement, $TimeOut, $Parameters)
{
    // not supported
    return
"<RESULTSET><FIELDS></FIELDS><ROWS></ROWS></RESULTSET>";
}

```



```

function ReturnsResultSet($ProcedureName)
{
    // not supported
    return "<RETURNSRESULTSET status=false></RETURNSRESULTSET>";
}

function SupportsProcedure()
{
    return "<SUPPORTSPROCEDURE status=false></SUPPORTSPROCEDURE>";
}

function HandleException()
{
    return "<ERRORS><ERROR Identification=\"\" . mysql_errno() .
        \"\"><DESCRIPTION>. mysql_errno() . \" \" . mysql_error() .
    "</DESCRIPTION></ERROR></ERRORS>";
}

function GetDatabaseList()
{
    $xmlOutput =
"<RESULTSET><FIELDS><FIELD><NAME>NAME</NAME></FIELD></FIELDS><ROW
S>";
    $dbList = mysql_list_dbs($this->connectionId);

    while ($row = mysql_fetch_object($dbList))
    {
        $xmlOutput .= "<ROW><VALUE>" . $row->Database .
"</VALUE></ROW>";
    }

    $xmlOutput .= "</ROWS></RESULTSET>";

    return $xmlOutput;
}

function GetPrimaryKeysOfTable($TableName)
{
    $xmlOutput = "";
    $query = "DESCRIBE $TableName";
    // $result = mysql_query($query) or die("Invalid query: $query");
    $result = mysql_query($query) or die("<ERRORS><ERROR Identification=\"\" .
mysql_errno() .
    \"\"><DESCRIPTION>. mysql_errno() . \" \" . mysql_error() .
"</DESCRIPTION></ERROR></ERRORS>");
}

```

```

if ($result)
{
    $xmlOutput = "<RESULTSET><FIELDS>";

    // Columns are referenced by index, so Schema and
    // Catalog must be specified even though they are not supported
    $xmlOutput .=
"<FIELD><NAME>TABLE_CATALOG</NAME></FIELD>";           // column 0 (zero-
based)
    $xmlOutput .=
"<FIELD><NAME>TABLE_SCHEMA</NAME></FIELD>";           // column 1
    $xmlOutput .=
"<FIELD><NAME>TABLE_NAME</NAME></FIELD>";           // column 2
    $xmlOutput .=
"<FIELD><NAME>COLUMN_NAME</NAME></FIELD>";
    $xmlOutput .= "<FIELD><NAME>DATA_TYPE</NAME></FIELD>";
    $xmlOutput .=
"<FIELD><NAME>IS_NULLABLE</NAME></FIELD>";
    $xmlOutput .=
"<FIELD><NAME>COLUMN_SIZE</NAME></FIELD>";

    $xmlOutput .= "</FIELDS><ROWS>";

    // The fields returned from DESCRIBE are: Field, Type, Null, Key,
Default, Extra
while ($row = mysql_fetch_array($result, MYSQL_ASSOC))
{
    if (strtoupper($row["Key"]) == "PRI"){
        $xmlOutput .= "<ROW><VALUE/><VALUE/><VALUE/>";

        // Separate type from size. Format is: type(size)
        if (ereg("(.*)(.*)", $row["Type"], $ret))
        {
            $type = $ret[1];
            $size = $ret[2];
        }
        else
        {
            $type = $row["Type"];
            $size = "";
        }

        // MySQL sets nullable to "YES" or "", so we need to set "NO"
        $null = $row["Null"];
        if ($null == "")

```

```

        $null = "NO";

        $xmlOutput .= "<VALUE>" . $row["Field"] . "</VALUE>";
        $xmlOutput .= "<VALUE>" . $type      . "</VALUE>";
        $xmlOutput .= "<VALUE>" . $null     . "</VALUE>";
        $xmlOutput .= "<VALUE>" . $size    . "</VALUE></ROW>";
    }
}
mysql_free_result($result);

$xmlOutput .= "</ROWS></RESULTSET>";
}
return $xmlOutput;
}

} // class MySqlConnection
?>

```

Screen3 Manual Excerpts

To Download Model: <http://www.epa.gov/scram001/tt22.htm#rec>

2.4 Point Source Example

When running SCREEN for a point source, or for flare releases and area sources discussed below, the user is first asked to provide a one line title (up to 79 characters) that will appear on the output file. The user will then be asked to identify the source type, and should enter 'P' or 'p' for a point source (the model will identify either upper or lower case letters and will repeat the prompt until a valid response is given).

For a point source, the user will be asked to provide the following inputs:

Point Source Inputs

Emission rate (g/s)

Stack height (m)

Stack inside diameter (m)

Stack gas exit velocity (m/s) or
flow rate (ACFM or m³/s)

Stack gas temperature (K)

Ambient temperature (K) (use default of 293K if not known)

Receptor height above ground (may be used to define flagpole receptors) (m)

Urban/rural option (U = urban, R = rural)

The SCREEN model uses free format to read the numerical input data, with the exception of the exit velocity/flow rate option. The default choice for this input is stack gas exit velocity, which SCREEN will read as free format. However, if the user precedes the input with the characters VF= in columns 1-3, then SCREEN will interpret the input as flow rate in actual cubic feet per minute (ACFM). Alternatively, if the user inputs the characters VM= in columns 1-3, then SCREEN will interpret the input as flow rate in m³/s. The user can input either upper or lower case characters for VF and VM. The flow rate values are then converted to exit velocity in m/s for use in the plume rise equations, based on the diameter of the stack.

SCREEN allows for the selection of urban or rural dispersion coefficients. The urban dispersion option is selected by entering a 'U' (lower or upper case) in column 1, while the rural dispersion option is selected by entering an 'R' (upper or lower case) in column 1. For compatibility with the previous version of the model, SCREEN also allows for an input of '1' to select the urban option, or a '2' to select the rural option. Determination of the applicability of urban or rural dispersion is based upon land use or population density. For determination by land use, (1) circumscribe a 3km radius circle, A_o, about the source using the meteorological land use typing scheme and (2) if land use types I1, I2, C1, R2, and R3 account for 50 percent or more of A_o, select the urban option, otherwise use the rural option. Using the population density

criteria, (1) compute the average population density, "p", per square kilometer with A_0 as defined above and (2) if "p" is greater than 750 people/km², use the urban option, otherwise select the rural option. Of the two methods, the land use procedure is considered more definitive. This guidance is extracted from Section 8.2.8 of the "Guideline On Air Quality Models (Revised)" and Supplement A (EPA, 1987a).

Figure 1 presents the order of options within the SCREEN model for point sources and is annotated with the corresponding sections from the screening procedures document. In order to obtain results from SCREEN corresponding to the procedures in Step 4 of Section 4.2, the user should select the full meteorology option, the automated distance array option, and, if applicable for the source, the simple elevated terrain option. The simple elevated terrain option would be used if the terrain rises above the stack base elevation but is less than the height of the physical stack. These, as well as the other options in Figure 1, are explained in more detail below. A flagpole receptor is defined as any receptor which is located above local ground level, e.g., to represent the roof or balcony of a building.

2.4.1 Building Downwash Option

Following the basic input of source characteristics SCREEN will first ask if building downwash is to be considered, and if so, asks for the building height, minimum horizontal dimension, and maximum horizontal dimension in meters. The downwash screening procedure assumes that the building can be approximated by a simple rectangular box. Wake effects are included in any calculations made using the automated distance array or discrete distance options (described below). Cavity calculations are made for two building orientations - first with the minimum horizontal building dimension alongwind, and second with the maximum horizontal dimension alongwind. The cavity calculations are summarized at the end of the distance-dependent calculations. Refer to Section 3.6 for more details on the building downwash cavity and wake screening procedure.

2.4.2 Complex Terrain Option

The complex terrain option of SCREEN allows the user to estimate impacts for cases where terrain elevations exceed stack height. If the user elects this option, then SCREEN will calculate and print out a final stable plume height and distance to final rise for the VALLEY model 24-hour screening technique. This technique assumes stability class F (E for urban) and a stack height wind speed of 2.5 m/s. For complex terrain, maximum impacts are expected to occur for plume impaction on the elevated terrain under stable conditions. The user is therefore instructed to enter minimum distances and terrain heights for which impaction is likely, given the plume height calculated, and taking into account complex terrain closer than the distance to final rise. If the plume is at or below the terrain height for the distance entered, then SCREEN will make a 24-hour concentration estimate using the VALLEY screening technique. If the terrain is above stack height but below plume centerline height for the distance entered, then SCREEN will make a VALLEY 24-hour estimate (assuming E or F and 2.5 m/s), and also estimate the maximum concentration across a full range of meteorological conditions using simple terrain procedures with terrain "chopped off" at physical stack height. The higher of the two estimates is selected as controlling for that distance and terrain height (both estimates are printed out for

comparison). The simple terrain estimate is adjusted to represent a 24-hour average by multiplying by a factor of 0.4, while the VALLEY 24-hour estimate incorporates the 0.25 factor used in the VALLEY model. Calculations continue for each terrain height/distance combination entered until a terrain height of zero is entered. The user will then have the option to continue with simple terrain calculations or to exit the program. It should be noted that SCREEN will not consider building downwash effects in either the VALLEY or the simple terrain component of the complex terrain screening procedure, even if the building downwash option is selected. SCREEN also uses a receptor height above ground of 0.0m (i.e. no flagpole receptors) in the complex terrain option even if a non-zero value is entered. The original receptor height is saved for later calculations. Refer to Section 3 for more details on the complex terrain screening procedure.

2.4.3 Simple Elevated or Flat Terrain Option

The user is given the option in SCREEN of modeling either simple elevated terrain, where terrain heights exceed stack base but are below stack height, or simple flat terrain, where terrain heights are assumed not to exceed stack base elevation. If the user elects not to use the option for simple terrain screening with terrain above stack base, then flat terrain is assumed and the terrain height is assigned a value of zero. If the simple elevated terrain option is used, SCREEN will prompt the user to enter a terrain height above stack base. If terrain heights above physical stack height are entered by the user for this option, they are chopped off at the physical stack height.

The simple elevated terrain screening procedure assumes that the plume elevation above sea level is not affected by the elevated terrain. Concentration estimates are made by reducing the calculated plume height by the user-supplied terrain height above stack base. Neither the plume height nor terrain height are allowed to go below zero. The user can model simple elevated terrain using either or both of the distance options described below, i.e., the automated distance array or the discrete distance option. When the simple elevated terrain calculations for each distance option are completed, the user will have the option of continuing simple terrain calculations for that option with a new terrain height. (For flat terrain the user will not be given the option to continue with a new terrain height). For conservatism and to discourage the user from modeling terrain heights that decrease with distance, the new terrain height for the automated distances cannot be lower than the previous height for that run. The user is still given considerable flexibility to model the effects of elevated terrain below stack height across a wide range of situations.

For relatively uniform elevated terrain, or as a "first cut" conservative estimate of terrain effects, the user should input the maximum terrain elevation (above stack base) within 50 km of the source, and exercise the automated distance array option out to 50 km. For isolated terrain features a separate calculation can be made using the discrete distance option for the distance to the terrain feature, with the terrain height input as the maximum height of the feature above stack base. Where terrain heights vary with distance from the source, then the SCREEN model can be run on each of several concentric rings using the minimum and maximum distance inputs of the automated distance option to define each ring, and using the maximum terrain elevation above stack base within each ring for terrain height input. As noted above, the terrain heights are not

allowed to decrease with distance in SCREEN. If terrain decreasing with distance (in all directions) can be justified for a particular source, then the distance rings would have to be modeled using separate SCREEN runs, and the results combined. The overall maximum concentration would then be the controlling value. The optimum ring sizes will depend on how the terrain heights vary with distance, but as a "first cut" it is suggested that ring sizes of about 5 km be used (i.e., 0-5km, 5-10km, etc.). The application of SCREEN to evaluating the effects of elevated terrain should be done in consultation with the permitting agency.

2.4.4 Choice of Meteorology

For simple elevated or flat terrain screening, the user will be given the option of selecting from three choices of meteorology: (1) full meteorology (all stability classes and wind speeds); (2) specifying a single stability class; or (3) specifying a single stability class and wind speed. Generally, the full meteorology option should be selected. The other two options were originally included for testing purposes only, but may be useful when particular meteorological conditions are of concern. Refer to Section 3 for more details on the determination of worst case meteorological conditions by SCREEN.

2.4.5 Automated Distance Array Option

The automated distance array option of SCREEN gives the user the option of using a pre-selected array of 50 distances ranging from 100m out to 50 km. Increments of 100m are used out to 3,000m, with 500m increments from 3,000m to 10 km, 5 km increments from 10 km to 30 km, and 10 km increments out to 50 km. When using the automated distance array, SCREEN prompts the user for a minimum and maximum distance to use, which should be input in free format, i.e., separated by a comma or a space. SCREEN then calculates the maximum concentration across a range of meteorological conditions for the minimum distance given (≥ 1 meter), and then for each distance in the array larger than the minimum and less than or equal to the maximum. Thus, the user can input the minimum site boundary distance as the minimum distance for calculation and obtain a concentration estimate at the site boundary and beyond, while ignoring distances less than the site boundary.

If the automated distance array is used, then the SCREEN model will use an iteration routine to determine the maximum value and associated distance to the nearest meter. If the minimum and maximum distances entered do not encompass the true maximum concentration, then the maximum value calculated by SCREEN may not be the true maximum. Therefore, it is recommended that the maximum distance be set sufficiently large initially to ensure that the maximum concentration is found. This distance will depend on the source, and some "trial and error" may be necessary, however, the user can input a distance of 50,000m to examine the entire array. The iteration routine stops after 50 iterations and prints out a message if the maximum is not found. Also, since there may be several local maxima in the concentration distribution associated with different wind speeds, it is possible that SCREEN will not identify the overall maximum in its iteration. This is not likely to be a frequent occurrence, but will be more likely for stability classes C and D due to the larger number of wind speeds examined.

2.4.6 Discrete Distance Option

The discrete distance option of SCREEN allows the user to input specific distances. Any number of distances (≥ 1 meter) can be input by the user and the maximum concentration for each distance will be calculated. The user will always be given this option whether or not the automated distance array option is used. The option is terminated by entering a distance of zero (0). SCREEN will accept distances out to 100 km for long-range transport estimates with the discrete distance option. However, for distances greater than 50 km, SCREEN sets the minimum 10 meter wind speed at 2 m/s to avoid unrealistic transport times.

2.4.7 Fumigation Option

Once the distance-dependent calculations are completed, SCREEN will give the user the option of estimating maximum concentrations and distance to the maximum associated with inversion break-up fumigation, and shoreline fumigation. The option for fumigation calculations is applicable only for rural inland sites with stack heights greater than or equal to 10 meters (within 3,000m onshore from a large body of water.) The fumigation algorithm also ignores any potential effects of elevated terrain.

Once all calculations are completed, SCREEN summarizes the maximum concentrations for each of the calculation procedures considered. Before execution is stopped, whether it is after complex terrain calculations are completed or at the end of the simple terrain calculations, the user is given the option of printing a hardcopy of the results. Whether or not a hardcopy is printed, the results of the session, including all input data and concentration estimates, are stored in a file called SCREEN.OUT. This file is opened by the model each time it is run. If a file named SCREEN.OUT already exists, then its contents will be overwritten and lost. Thus, if you wish to save results of a particular run, then change the name of the output file using the DOS RENAME command, e.g., type 'REN SCREEN.OUT SAMPLE1.OUT', or print the file using the option at the end of the program. If SCREEN.OUT is later printed using the DOS PRINT command, the FORTRAN carriage controls will not be observed. (Instructions are included in Section 4 for simple modifications to the SCREEN code that allow the user to specify an output filename for each run.)

Figure 2 shows an example using the complex terrain screen only. Figure 3 shows an example for an urban point source which uses the building downwash option. In the DWASH column of the output, 'NO' indicates that no downwash is included, 'HS' means that Huber-Snyder downwash is included, 'SS' means that Schulman-Scire downwash is included, and 'NA' means that downwash is not applicable since the downwind distance is less than $3L_b$. A blank in the DWASH column means that no calculation was made for that distance because the concentration was so small.

Figure 4 presents a flow chart of all the inputs and various options of SCREEN for point sources. Also illustrated are all of the outputs from SCREEN. If a cell on the flow chart does not contain the words "Enter" or "Print out", then it is an internal test or process of the program, and is included to show the flow of the program.

2.5 Flare Release Example

By answering 'F' or 'f' to the question on source type the user selects the flare release option. This option is similar to the point source described above except for the inputs needed to calculate plume rise. The inputs for flare releases are as follows:

Flare Release Inputs

Emission rate (g/s)
Flare stack height (m)
Total heat release rate (cal/s)
Receptor height above ground (m)
Urban/rural option (U = urban, R = rural)

The SCREEN model calculates plume rise for flares based on an effective buoyancy flux parameter. An ambient temperature of 293K is assumed in this calculation and therefore none is input by the user. It is assumed that 55 percent of the total heat is lost due to radiation. Plume rise is calculated from the top of the flame, assuming that the flame is bent 45 degrees from the vertical. SCREEN calculates and prints out the effective release height for the flare. SCREEN provides the same options for flares as described earlier for point sources, including building downwash, complex and/or simple terrain, fumigation, and the automated and/or discrete distances. The order of these options and the user prompts are the same as described for the point source example.

While building downwash is included as an option for flare releases, it should be noted that SCREEN assumes an effective stack gas exit velocity (v_s) of 20 m/s and an effective stack gas exit temperature (T_s) of 1,273K, and calculates an effective stack diameter based on the heat release rate. These effective stack parameters are somewhat arbitrary, but the resulting buoyancy flux estimate is expected to give reasonable final plume rise estimates for flares. However, since building downwash estimates depend on transitional momentum plume rise and transitional buoyant plume rise calculations, the selection of effective stack parameters could influence the estimates. Therefore, building downwash estimates should be used with extra caution for flare releases. If more realistic stack parameters can be determined, then the estimate could alternatively be made with the point source option of SCREEN. In doing so, care should be taken to account for the vertical height of the flame in specifying the release height (see Section 3). Figure 5 shows an example for a flare release, and Figure 6 shows a flow chart of the flare release inputs, options, and output.

2.6 Area Source Example

The third source type option in SCREEN is for area sources, which is selected by entering 'A' or 'a' for source type. The area source algorithm in SCREEN is based on a numerical integration approach, and allows for the area source to be approximated by a rectangular area. The inputs requested for area sources are as follows:

Area Source Inputs

Emission rate [$\text{g}/(\text{s}\cdot\text{m}^2)$]

Source release height (m)

Length of larger side of the rectangular area (m)

Length of smaller side of the rectangular area (m)

Receptor height above ground (m)

Urban/rural option (U = urban, R = rural)

Wind direction search option (if no, specify
desired angle)

Note that the emission rate for area sources is input as an emission rate per unit area in units of $\text{g}/(\text{s}\cdot\text{m}^2)$. These units are consistent with the ISCST model.

Since the concentration at a particular distance downwind from a rectangular area is dependent on the orientation of the area relative to the wind direction, the SCREEN model provides the user with two options for treating wind direction. The first option, which should be used for most applications of SCREEN and is the regulatory default, is for the model to search through a range of wind directions to find the maximum concentration. The range of directions used in the search is determined from a set of look-up tables based on the aspect ratio of the area source, the stability category, and the downwind distance. The SCREEN model also provides the user an option to specify a wind direction orientation relative to the long axis of the rectangular area. The second option may be used to estimate the concentration at a particular receptor location relative to the area. The output table for area sources includes the wind direction associated with the maximum concentration at each distance.

The user has the same options for handling distances and the same choices of meteorology as described above for point sources, but no complex terrain, elevated simple terrain, building downwash, or fumigation calculations are made for area sources. Distances are measured from the center of the rectangular area. Since the numerical integration algorithm can estimate concentrations within the area source, the user can enter any value for the minimum distance. Figure 7 shows an example of SCREEN for an area source, using both the automated and discrete distance options. Figure 8 provides a flow chart of inputs, options, and outputs for area sources.

2.7 Volume Source Example

The fourth source type option in SCREEN is for volume sources, which is selected by entering 'V' or 'v' for source type. The volume source algorithm is based on a virtual point source approach, and may be used for non-buoyant sources whose emissions occupy some initial volume. The inputs requested for volume sources are as follows:

Volume Source Inputs

Emission rate (g/s)
 Source release height (m)
 Initial lateral dimension of volume (m)
 Initial vertical dimension of volume (m)
 Receptor height above ground (m)
 Urban/rural option (U = urban, R = rural)

The user must determine the initial dimensions of the volume source plume before exercising the SCREEN model volume source. Table 1 provides guidance on determining these inputs. Since the volume source algorithm cannot estimate concentrations within the volume source, the model will give a concentration of zero for distances (measured from the center of the volume) of less than $2.15 s_{y0}$. Figure 9 shows an example of SCREEN for a volume source, and Figure 10 provides a flow chart of inputs, options, and outputs for volume sources.

TABLE 1.
 SUMMARY OF SUGGESTED PROCEDURES FOR ESTIMATING
 INITIAL LATERAL DIMENSIONS (s_{y0}) AND
 INITIAL VERTICAL DIMENSIONS (s_{z0}) FOR VOLUME SOURCES

Description of Source	Initial Dimension
(a) Initial Lateral Dimensions (s_{y0})	
Single Volume Source	s_{y0} = length of side divided by 4.3
(b) Initial Vertical Dimensions (s_{z0})	
Surface-Based Source ($h_e \sim 0$)	s_{z0} = vertical dimension of source divided by 2.15
Elevated Source ($h_e > 0$) on or Adjacent to a Building	s_{z0} = building height divided by 2.15
Elevated Source ($h_e > 0$) not on or Adjacent to a Building	s_{z0} = vertical dimension of source divided by 4.3

3. TECHNICAL DESCRIPTION

Most of the techniques used in the SCREEN model are based on assumptions and methods common to other EPA dispersion models. For the sake of brevity, lengthy technical descriptions that are available elsewhere are not duplicated here. This discussion will concentrate on how those methods are incorporated into SCREEN and on describing those techniques that are unique to SCREEN.

3.1 Basic Concepts of Dispersion Modeling

SCREEN uses a Gaussian plume model that incorporates source-related factors and meteorological factors to estimate pollutant concentration from continuous sources. It is assumed that the pollutant does not undergo any chemical reactions, and that no other removal processes, such as wet or dry deposition, act on the plume during its transport from the source. The Gaussian model equations and the interactions of the source-related and meteorological factors are described in Volume II of the ISC user's guide (EPA, 1995b), and in the Workbook of Atmospheric Dispersion Estimates (Turner, 1970).

The basic equation for determining ground-level concentrations under the plume centerline is:

$$\begin{aligned}
 X = & Q / (2 p u_s s_y s_z) \{ \exp[-1/2((z_r - h_e) / s_z)^2] \\
 & + \exp[-1/2((z_r + h_e) / s_z)^2] \\
 & + \sum_{N=1}^k [\exp[-1/2((z_r - h_e - 2Nz_i) / s_z)^2] \\
 & + \exp[-1/2((z_r + h_e - 2Nz_i) / s_z)^2] \\
 & + \exp[-1/2((z_r - h_e + 2Nz_i) / s_z)^2] \\
 & + \exp[-1/2((z_r + h_e + 2Nz_i) / s_z)^2]] \} \quad (1)
 \end{aligned}$$

where:

- X = concentration (g/m³)
- Q = emission rate (g/s)
- p = 3.141593
- u_s = stack height wind speed (m/s)
- s_y = lateral dispersion parameter (m)
- s_z = vertical dispersion parameter (m)
- z_r = receptor height above ground (m)
- h_e = plume centerline height (m)

z_i = mixing height (m)

k = summation limit for multiple reflections of plume off of the ground and elevated inversion, usually ≤ 4 .

Note that for stable conditions and/or mixing heights greater than or equal to 10,000m, unlimited mixing is assumed and the summation term is assumed to be zero.

Equation 1 is used to model the plume impacts from point sources, flare releases, and volume releases in SCREEN. The SCREEN volume source option uses a virtual point source approach, as described in Volume II (Section 1.2.2) of the ISC model user's guide (EPA, 1995b). The user inputs the initial lateral and vertical dimensions of the volume source, as described in Section 2.7 above.

The SCREEN model uses a numerical integration algorithm for modeling impacts from area sources, as described in Volume II (Section 1.2.3) of the ISC model user's guide (EPA, 1995b). The area source is assumed to be a rectangular shape, and the model can be used to estimate concentrations within the area.

3.2 Worst Case Meteorological Conditions

SCREEN examines a range of stability classes and wind speeds to identify the "worst case" meteorological conditions, i.e., the combination of wind speed and stability that results in the maximum ground level concentrations. The wind speed and stability class combinations used by SCREEN are given in Table 2. The 10-meter wind speeds given in Table 2 are adjusted to stack height by SCREEN using the wind profile power law exponents given in Table 3-1 of the screening procedures document. For release heights of less than 10 meters, the wind speeds listed in Table 2 are used without adjustment. For distances greater than 50 km (available with the discrete distance option), SCREEN sets 2 m/s as the lower limit for the 10-meter wind speed to avoid unrealistic transport times. Table 2 includes some cases that may not be considered standard stability class/wind speed combinations, namely E with winds less than 2 m/s, and F with winds greater than 3 m/s. The combinations of E and winds of 1 - 1.5 m/s are often excluded because the algorithm developed by Turner (1964) to determine stability class from routine National Weather Service (NWS) observations excludes cases of E stability for wind speeds less than 4 knots (2 m/s). These combinations are included in SCREEN because they are valid combinations that could appear in a data set using on-site meteorological data with another stability class method. A wind speed of 6 knots (the highest speed for F stability in Turner's scheme) measured at a typical NWS anemometer height of 20 feet (6.1 meters) corresponds to a 10 meter wind speed of 4 m/s under F stability. Therefore the combination of F and 4 m/s has been included.

Table 2. Wind Speed and Stability Class Combinations Used by the SCREEN Model													
Stability Class	10-m Wind Speed (m/s)												
	1	1.5	2	2.5	3	3.5	4	4.5	5	8	10	15	20
A	*	*	*	*	*								
B	*	*	*	*	*	*	*	*	*				
C	*	*	*	*	*	*	*	*	*	*	*		
D	*	*	*	*	*	*	*	*	*	*	*	*	*
E	*	*	*	*	*	*	*	*	*				
F	*	*	*	*	*	*	*						

The user has three choices of meteorological data to examine. The first choice, which should be used in most applications, is to use "Full Meteorology" which examines all six stability classes (five for urban sources) and their associated wind speeds. Using full meteorology with the automated distance array (described in Section 2), SCREEN prints out the maximum concentration for each distance, and the overall maximum and associated distance. The overall maximum concentration from SCREEN represents the controlling 1-hour value corresponding to the result from Procedures (a) - (c) in Step 4 of Section 4.2. Full meteorology is used instead of the A, C, and E or F subset used by the hand calculations because SCREEN provides maximum concentrations as a function of distance, and stability classes A, C and E or F may not be controlling for all distances. The use of A, C, and E or F may also not give the maximum concentration when building downwash is considered. The second choice is to input a single stability class (1 = A, 2 = B, ..., 6 = F). SCREEN will examine a range of wind speeds for that stability class only. Using this option the user is able to determine the maximum concentrations associated with each of the individual procedures, (a) - (c), in Step 4 of Section 4.2. The third choice is to specify a single stability class and wind speed. The last two choices were originally put into SCREEN to facilitate testing only, but they may be useful if particular meteorological conditions are of concern. However, they are not recommended for routine uses of SCREEN.

The mixing height used in SCREEN for neutral and unstable conditions (classes A-D) is based on an estimate of the mechanically driven mixing height. The mechanical mixing height, z_m (m), is calculated (Randerson, 1984) as

$$z_m = 0.3 u^*/f \quad (2)$$

where: u^* = friction velocity (m/s)

f = Coriolis parameter ($9.374 \times 10^{-5} \text{ s}^{-1}$ at 40° latitude)

Using a log-linear profile of the wind speed, and assuming a surface roughness length of about 0.3m, u^* is estimated from the 10-meter wind speed, u_{10} , as

$$u^* = 0.1 u_{10} \quad (3)$$

Substituting for u^* in Equation 2 we have

$$z_m = 320 u_{10}. \quad (4)$$

The mechanical mixing height is taken to be the minimum daytime mixing height. To be conservative for limited mixing calculations, if the value of z_m from Equation 3 is less than the plume height, h_e , then the mixing height used in calculating the concentration is set equal to $h_e + 1$. For stable conditions, the mixing height is set equal to 10,000m to represent unlimited mixing.

3.3 Plume Rise for Point Sources

The use of the methods of Briggs to estimate plume rise are discussed in detail in Section 1.1.4 of Volume II of the ISC user's guide (EPA, 1995b). These methods are also incorporated in the SCREEN model.

Stack tip downwash is estimated following Briggs (1973, p.4) for all sources except those employing the Schulman-Scire downwash algorithm. Buoyancy flux for non-flare point sources is calculated from

$$F_b = g v_s d_s^2 (T_s - T_a) / (4 T_s), \quad (5)$$

which is described in Section 4 of the screening procedures document and is equivalent to Briggs' (1975, p. 63) Equation 12.

Buoyancy flux for flare releases is estimated from

$$F_b = 1.66 \times 10^{-5} \times H, \quad (6)$$

where H is the total heat release rate of the flare (cal/s). This formula was derived from Equation 4.20 of Briggs (1969), assuming $T_a = 293\text{K}$, $p = 1205 \text{ g/m}$, $c_p = 0.24$

cal/gK, and that the sensible heat release rate, $Q_H = (0.45) H$. The sensible heat rate is based on the assumption that 55 percent of the total heat released is lost due to radiation (Leahey and Davies, 1984). The buoyancy flux for flares is calculated in SCREEN by assuming effective stack parameters of $v_s = 20$ m/s, $T_s = 1,273$ K, and solving for an effective stack diameter, $d_s = 9.88 \times 10^{-4}(Q_H)^{0.5}$.

The momentum flux, which is used in estimating plume rise for building downwash effects, is calculated from,

$$F_m = v_s^2 d_s^2 T_a / (4T_s). \quad (7)$$

The ISC user's guide (EPA, 1995b) describes the equations used to estimate buoyant plume rise and momentum plume rise for both unstable/neutral and stable conditions. Also described are transitional plume rise and how to estimate the distance to final rise. Final plume rise is used in SCREEN for all cases with the exception of the complex terrain screening procedure and for building downwash effects.

The buoyant line source plume rise formulas that are used for the Schulman-Scire downwash scheme are described in Section 1.1.4.11 of Volume II of the ISC user's guide (EPA, 1995b). These formulas apply to sources where $h_s \leq H_b + 0.5L_b$. For sources subject to downwash but not meeting this criterion, the downwash algorithms of Huber and Snyder (EPA, 1995b) are used, which employ the Briggs plume rise formulas referenced above.

3.4 Dispersion Parameters

The formulas used for calculating vertical (s_z) and lateral (s_y) dispersion parameters for rural and urban sites are described in Section 1.1.5 of Volume II of the ISC user's guide (EPA, 1995b).

3.5 Buoyancy Induced Dispersion

Throughout the SCREEN model, with the exception of the Schulman-Scire downwash algorithm, the dispersion parameters, s_y and s_z , are adjusted to account for the effects of buoyancy induced dispersion as follows:

$$s_{ye} = (s_y^2 + (\Delta h/3.5)^2)^{0.5} \quad (8)$$

$$s_{ze} = (s_z^2 + (\Delta h/3.5)^2)^{0.5}$$

where Δh is the distance-dependent plume rise. (Note that for inversion break-up and shoreline fumigation, distances are always beyond the distance to final rise, and therefore $\Delta h =$ final plume rise).

3.6 Building Downwash

3.6.1 Cavity Recirculation Region

The cavity calculations are a revision of the procedure described in the Regional Workshops on Air Quality Modeling Summary Report, Appendix C (EPA, 1983), and are based largely on results published by Hosker (1984).

If non-zero building dimensions are input to SCREEN for either point or flare releases, then cavity calculations will be made as follows. The cavity height, h_c (m), is estimated based on the following equation from Hosker (1984):

$$h_c = h_b (1.0 + 1.6 \exp(-1.3L/h_b)), \quad (9)$$

where: h_b = building height (m)
 L = alongwind dimension of the building (m).

Using the plume height based on momentum rise at two building heights downwind, including stack tip downwash, a critical (i.e., minimum) stack height wind speed is calculated that will just put the plume into the cavity (defined by plume centerline height = cavity height). The critical wind speed is then adjusted from stack height to 10-meter using a power law with an exponent of 0.2 to represent neutral conditions (no attempt is made to differentiate between urban or rural sites or different stability classes). If the critical wind speed (adjusted to 10-meters) is less than or equal to 20 m/s, then a cavity concentration is calculated, otherwise the cavity concentration is assumed to be zero. Concentrations within the cavity, X_c , are estimated by the following approximation (Hosker, 1974):

$$X_c = Q / (1.5 A_p u) \quad (10)$$

where: Q = emission rate (g/s)
 $A_p = H_b \cdot W$ = cross-sectional area of the building normal to the wind (m²)
 W = crosswind dimension of the building (m)
 u = wind speed (m/s).

For u , a value of one-half the stack height critical wind speed is used, but not greater than 10 m/s and not less than 1 m/s. Thus, the calculation of X_c is linked to the determination of a critical wind speed. The concentration, X_c , is assumed to be uniform within the cavity.

The cavity length, x_r , measured from the lee side of the building, is estimated by the following (Hosker, 1984):

(1) for short buildings ($L/h_b \leq 2$),

$$x_r = \frac{(A)(W)}{1.0 + B(W/h_b)} \quad (11)$$

(2) for long buildings ($L/h_b \geq 2$),

$$x_r = \frac{1.75 (W)}{1.0 + 0.25(W/h_b)} \quad (12)$$

where: h_b = building height (m)
 L = alongwind building dimension (m)
 W = crosswind building dimension (m)
 $A = -2.0 + 3.7 (L/h_b)^{-1/3}$, and
 $B = -0.15 + 0.305 (L/h_b)^{-1/3}$.

The equations above for cavity height, concentration and cavity length are all sensitive to building orientation through the terms L , W and A_p . Therefore, the entire cavity procedure is performed for two orientations, first with the minimum horizontal dimension alongwind and second with the maximum horizontal dimension alongwind. For screening purposes, this is thought to give reasonable bounds on the cavity estimates. The first case will maximize the cavity height, and therefore minimize the critical wind speed. However, the A_p term will also be larger and will tend to reduce concentrations. The highest concentration that potentially effects ambient air should be used as the controlling value for the cavity procedure.

3.6.2 Wake Region

The calculations for the building wake region are based on the ISC model (EPA, 1995b). The wake effects are divided into two regions, one referred to as the "near wake" extending from $3L_b$ to $10L_b$ (L_b is the lesser of the building height, h_b , and maximum projected width), and the other as the "far wake" for distances greater than $10L_b$. For the SCREEN model, the maximum projected width is calculated from the input minimum and maximum horizontal dimensions as $(L^2 + W^2)^{0.5}$. The remainder of the building wake calculations in SCREEN are based on the ISC user's guide (EPA, 1995b).

It should be noted that, unlike the cavity calculation, the comparison of plume height (due to momentum rise at two building heights) to wake height to determine if wake effects apply does not include stack tip downwash. This is done for consistency with the ISC model.

3.7 Fumigation

3.7.1 Inversion Break-up Fumigation

The inversion break-up screening calculations are based on procedures described in the Workbook of Atmospheric Dispersion Estimates (Turner, 1970). The distance to maximum fumigation is based on an estimate of the time required for the mixing layer to develop from the top of the stack to the top of the plume, using Equation 5.5 of Turner (1970):

$$x_{\max} = u t_m = (u p_a c_p / R) (\partial T / \partial z) (h_i - h_s) [(h_i + h_s) / 2] \quad (13)$$

where

- x_{\max} = downwind distance to maximum concentration (m)
- t_m = time required for mixing layer to develop from top of stack to top of plume (s)
- u = wind speed (2.5 m/s assumed)
- p_a = ambient air density (1205 g/m³ at 20°C)
- c_p = specific heat of the air at constant pressure (0.24 cal/gK)
- R = net rate of sensible heating of an air column by solar radiation (about 67 cal/m²/s)
- $\partial T / \partial z$ = vertical potential temperature gradient (assume 0.035 K/m for F stability)
- h_i = height of the top of the plume (m) = $h_e + 2s_{ze}$ (h_e is the plume centerline height)
- h_s = physical stack height (m).
- s_{ze} = vertical dispersion parameter incorporating buoyancy induced dispersion (m)

The values of u and $\partial T / \partial z$ are based on assumed conditions of stability class F and stack height wind speed of 2.5 m/s for the stable layer above the inversion. The value of h_i incorporates the effect of buoyancy induced dispersion on s_z , however, elevated terrain effects are ignored. The equation above is solved by iteration, starting from an initial guess of $x_{\max} = 5,000\text{m}$.

The maximum ground-level concentration due to inversion break-up fumigation, X_f , is calculated from Equation 5.2 of Turner (1970).

$$X_f = Q / [(2p)^{0.5} u (s_{ye} + h_e / 8) (h_e + 2s_{ze})] \quad (14)$$

where Q is the emission rate (g/s), and other terms are defined above. The dispersion parameters, s_{ye} and s_{ze} , incorporate the effects of buoyancy induced dispersion. If the distance to the maximum fumigation is less than 2000m, then SCREEN sets $X_f = 0$ since for such short distances the fumigation concentration is not likely to exceed

the unstable/limited mixing concentration estimated by the simple terrain screening procedure.

3.7.2 Shoreline Fumigation

For rural sources within 3000m of a large body of water, maximum shoreline fumigation concentrations can be estimated by SCREEN. A stable onshore flow is assumed with stability class F ($\partial T/\partial z = 0.035 \text{ K/m}$) and stack height wind speed of 2.5 m/s. Similar to the inversion break-up fumigation case, the maximum ground-level shoreline fumigation concentration is assumed to occur where the top of the stable plume intersects the top of the well-mixed thermal internal boundary layer (TIBL).

An evaluation of coastal fumigation models (EPA, 1987b) has shown that the TIBL height as a function of distance inland is well-represented in rural areas with relatively flat terrain by an equation of the form:

$$h_T = A [x]^{0.5} \quad (15)$$

where:

- h_T = height of the TIBL (m)
- A = TIBL factor containing physics needed for TIBL parameterization (including heat flux) ($\text{m}^{1/2}$)
- x = inland distance from shoreline (m).

Studies (e.g. Misra and Onlock, 1982) have shown that the TIBL factor, A , ranges from about 2 to 6. For screening purposes, A is conservatively set equal to 6, since this will minimize the distance to plume/TIBL intersection, and therefore tend to maximize the concentration estimate.

As with the inversion break-up case, the distance to maximum ground-level concentration is determined by iteration. The equation used for the shoreline fumigation case is:

$$x_{\max} = [(h_e + 2s_{ze})/6]^2 - x_s \quad (16)$$

where:

- x_{\max} = downwind distance to maximum concentration (m)
- x_s = shortest distance from source to shoreline (m)
- h_e = plume centerline height (m)
- s_{ze} = vertical dispersion parameter incorporating buoyancy induced dispersion (m)

Plume height is based on the assumed F stability and 2.5 m/s wind speed, and the dispersion parameter (s_{ze}) incorporates the effects of buoyancy induced dispersion. If x_{\max} is less than 200m, then no shoreline fumigation calculation is made, since the

plume may still be influenced by transitional rise and its interaction with the TIBL is more difficult to model.

The maximum ground-level concentration due to shoreline fumigation, X_f , is also calculated from Turner's (1970) Equation 5.2:

$$X_f = Q / [(2p)^{0.5} u (s_{ye} + h_e/8)(h_e + 2s_{ze})] \quad (14)$$

with s_{ye} and s_{ze} incorporating the effects of buoyancy induced dispersion.

Even though the calculation of x_{max} above accounts for the distance from the source to the shoreline in x_s , extra caution should be used in interpreting results as the value of x_s increases. The use of $A=6$ in Equations 15 and 16 may not be conservative in these cases since there will be an increased chance that the plume will be calculated as being below the TIBL height, and therefore no fumigation concentration estimated. Whereas a smaller value of A could put the plume above the TIBL with a potentially high fumigation concentration. Also, this screening procedure considers only TIBLs that begin formation at the shoreline, and neglects TIBLs that begin to form offshore.

3.8 Complex Terrain 24-hour Screen

The SCREEN model also contains the option to calculate maximum 24-hour concentrations for terrain elevations above stack height. A final plume height and distance to final rise are calculated based on the VALLEY model screening technique (Burt, 1977) assuming conditions of F stability (E for urban) and a stack height wind speed of 2.5 m/s. Stack tip downwash is incorporated in the plume rise calculation.

The user then inputs a terrain height and a distance (m) for the nearest terrain feature likely to experience plume impaction, taking into account complex terrain closer than the distance to final rise. If the plume height is at or below the terrain height for the distance entered, then SCREEN will make a 24-hour average concentration estimate using the VALLEY screening technique. If the terrain is above stack height but below plume centerline height, then SCREEN will make a VALLEY 24-hour estimate (assuming F or E and 2.5 m/s), and also estimate the maximum concentration across a full range of meteorological conditions using simple terrain procedures with terrain "chopped off" at physical stack height, and select the higher estimate. Calculations continue until a terrain height of zero is entered. For the VALLEY model concentration SCREEN will calculate a sector-averaged ground-level concentration with the plume centerline height (h_e) as the larger of 10.0m or the difference between plume height and terrain height. The equation used is

$$X = \frac{2.032 Q}{s_{ze} u x} \exp [-0.5(h_e/s_{ze})^2]. \quad (17)$$

Note that for screening purposes, concentrations are not attenuated for terrain heights above plume height. The dispersion parameter, s_{ze} , incorporates the effects of buoyancy induced dispersion (BID). For the simple terrain calculation SCREEN examines concentrations for the full range of meteorological conditions and selects the highest ground level concentration. Plume heights are reduced by the chopped off terrain height for the simple terrain calculation. To adjust the concentrations to 24-hour averages, the VALLEY screening value is multiplied by 0.25, as done in the VALLEY model, and the simple terrain value is multiplied by the 0.4 factor used in Step 5 of Section 4.2.