

See discussions, stats, and author profiles for this publication at: <https://www.researchgate.net/publication/242749515>

Molecular Investigation of Leber's Hereditary Optic Neuropathy Common Mutations in Suspected Patients

Article *in* Iranian Journal of Public Health · August 2004

CITATION

1

READS

20

6 authors, including:



[Laris Andonian](#)

Tehran University of Medical Sciences

10 PUBLICATIONS 21 CITATIONS

[SEE PROFILE](#)



[Mansoureh Togha](#)

Tehran University of Medical Sciences

64 PUBLICATIONS 338 CITATIONS

[SEE PROFILE](#)

Molecular Investigation of Leber's Hereditary Optic Neuropathy Common Mutations in Suspected Patients

HR Soleimanpour^{1,*}, DD Farhud^{1,2}, SK Bidooki³, L Andonian¹, M Togha⁴, M Khanlari⁵

¹ *Dept. of Human Genetics, School of Public Health, Tehran University of Medical Sciences, Iran*

² *Genetic Clinic, Vallie Asr Sq, Tehran, Iran*

³ *Dept. of Genetics, Tarbiat Modares University, Tehran, Iran*

⁴ *Dept. of Neurology, Sina Hospital, Tehran University of Medical Sciences, Iran*

⁵ *Dept. of Retina, Farabi Hospital, Tehran University of Medical Sciences, Iran*

Abstract

LHON is a mitochondrial neurodegenerative disorder often manifesting itself in the second or third decade of life, and hence resulting in progressive central vision loss usually in a short period of 2-8 weeks within which different degrees of blindness may occur. Etiologically, more than twenty missense mutations have been reported for LHON, amongst which the three mutations of G11778A, G3460A and T14484C, affecting NADH dehydrogenase complex activity, are recognized as primary mutations. The three primary mutations account for 90% of LHON patients, emphasizing the importance of molecular investigation of these mutations for differential diagnosis of LHON. Using PCR-RFLP, this research resulted in the detection of two LHON families carrying the G11778A mutation in homoplasmy and described the clinical and molecular features of the disease in the patients.

Keywords: *LHON, G11778A, G3460A, T14484C, NADH, PCR-RFLP, Iran*

Introduction

Leber's Hereditary Optic Neuropathy (LHON), the first disease to be associated with mtDNA point mutation, is a maternally inherited form of bilateral optic atrophy (1). It is characterized by a reduction in central vision acuity (central and cecentral scotoma) and color vision loss, first in one eye and then in the other, progressing to a usually painless, complete or near complete loss of sight within a few months. The mean age of the onset is in the mid-20, but can range from children under the age of 10 years to adults in their 70's (2, 3). The fundoscopic appearance in the acute stage of LHON is diagnostic but may not easily be seen. Early change in this stage is a pseudoedema of the Nerve Fiber Layer (NFL) and hyperemia of the optic disk; the disk subsequently flattens and becomes pale during the atrophic stage. The peripapillary nerve fiber layer disappears, initially in the papillomacular bundle (4). The charac-

teristic feature of LHON is a peripapillary microangiopathy, first described by Theodor Leber (1871), which involves tortuous vessels in the central retina and telangiectatic capillaries showing no leakage or staining in the Fluorescein Angiography (5). The optic neuropathy in LHON families shows incomplete penetrance. More prevalent in males, LHON is believed to initiate visual loss in 80-90% of the carriers while only 8-32% of females demonstrate a loss of vision attributable to LHON (6). Reportedly, LHON comprises 3% of the occurrence of blindness in young men (7). Etiologically, 23 missense mutations have been reported for LHON, amongst which the three mutations of G11778A (ND4/R340H), G3460A (ND1/A52T) and T14484C (ND6/M64V), affecting NADH dehydrogenase complex activities, have been recognized as primary mutations and the others are being considered as secondary mutations (1, 8-10). The three primary

mutations account for 90% of LHON patients, emphasizing the importance of molecular investigation of these mutations for differential diagnosis of LHON (11). This research, with its practical goal of establishing the molecular diagnosis of LHON and characterizing the specific pattern of this disease in Iran, resulted in the detection of two LHON families carrying the G11778A mutation in homoplasmy.

Materials and Methods

Blood samples from patients suspected to have LHON were sent by ophthalmologists of different hospitals of Tehran, especially Farabi Hospital. Samples from normal subjects and from patients with other neurological diseases were used as controls. To provide DNA samples, total DNA was extracted from the peripheral blood samples using phenol-chloroform method as outlined in Molecular Cloning. To investigate the occurrence of the G11778A, G3460A and T14484C mutations in the suspected patients, we used PCR-RFLP (12, 13). As regards the G11778A mutation, we designed a forward primer at nucleotide position 11646-11662 (5'-TCGTAACAGCCATTGTC) and a reverse primer at nucleotide position 11841-11860 (5'-GACGTTAGCGACGCTTCGTA).

The amplification process (Polymerase Chain Reaction) yielded a 214-bp product, which then was treated with *Mae* III restriction enzyme for one hour in 50°C. *Mae* III cleaved the 214-bp PCR product to two smaller fragments of 132 and 82 bp in those who carried the mutation. 1.5% agarose gel was used for electrophoresis of digested products and was stained with ethidium bromide. In order to detect the G3460A mutation, we constructed a forward primer at nucleotide position 3232-3248 (5'-TAAGATGGGAGAGCCCG) and a reverse primer at nucleotide position 4233-4250 (5'-GGAATGCTGGAGATTGTA), and then amplified the 1081-bp long sequence flanked by the respected primers. *Acy* I was used as the restriction enzyme cutting the 1081-bp PCR

product to smaller fragments of 792 and 226 bp, subject to no mutation occurrence, in the condition of 12 h treatment in 37°C. For the T14484C mutation detection, a forward mismatched primer was designed at nucleotide position 14463-14483 (5'-TAGTATATCCAA-AGACACAGA; mismatched at bold underlined nucleotide) by which a restriction (GATC) for restriction enzyme *Mbo* I would be created. The sequence for reverse primer was at nucleotide position 14519-14538 (5'-TTTGGGGGATAT-ATGGG). In the presence of the wild-type sequence at nucleotide position 14484, the mismatched primer creating a *Mbo* I restriction site, had the 75-bp PCR product excised into 54 and 21 nucleotide bands after treatment with *Mbo* I. The 14484 T-to-C mutations destroy the *Mbo* I site, and the 75 nucleotide product would remain uncut.

Results

This research with its practical goal of establishing the molecular diagnosis of LHON resulted in the detection of two LHON families comprising of 9 patients. The first family contained two affected maternal cousins (Fig. 1). In this family, the proband was a 23 year-old man with one younger and two older brothers. None of his first-degree relatives showed the acute symptoms of LHON. But, in line with the maternal inheritance of LHON, his 32-year-old maternal cousin with 8-member family also suffered from the clinical complications of LHON. The manifestation of clinical symptom of LHON in the proband was progressive. He first complained of blurring of the sight of his left eye and felt no problem in his right eye. Then, the visual acuity of his left and right eyes were 20/200 and 20/25 respectively. Relative Afferent Pupillary Defect (RAPD) was negative and slit examination showed nothing worthy of consideration. IOP for both eyes was 10 mmHg. In fundoscopic image of left eye, hyperemia, peripapillary telangiectasia and NFL swelling were evident and these symptoms could be seen in

the right eye but with milder features (Fig. 2). Fluorescein angiography of both eyes showed no leakage or staining in blood vessels of proband's fundus, indicating no damage in their walls (Fig. 3). The proband's Hemphry visual field for left eye showed cecocentral scotoma, developed progressively up to the point that the proband's left eye sight decreased to the level of finger count after two weeks (Fig. 4). Six months after the onset of LHON, another perimetry examination was taken for the proband and it revealed a slight recovery in left eye vision. Fundoscopic images of proband's maternal cousin who was in the atrophic phase of LHON, showed temporal pallor of optic disks as well as vascular degeneration of the area (Fig. 5). The same features held good for the fundoscopic images of proband's mother while those of his brothers showed no special features

(Fig. 6). PCR-RFLP analysis of this proband revealed that he carried the G11778A in homoplasmy. This analysis showed the same result for his three brothers, mothers and maternal cousin (Fig. 7). The second family included three affected brothers and their sister as well as one maternal uncle and two half-maternal uncles of them (Fig. 8). Maternal inheritance of the disorder is evident in the pedigree. In this pedigree, it seems that the marriage of a man with two carrier sisters transmitted the disorder to their descendents. PCR-RFLP analysis of this family demonstrated the occurrence of G11778A mutation in homoplasmy in all of the members who were maternally related to each other (Fig. 9). PCR-RFLP analysis for the occurrence of the G3460A and T14484C mutations was negative for all the tested patients (Fig. 10).

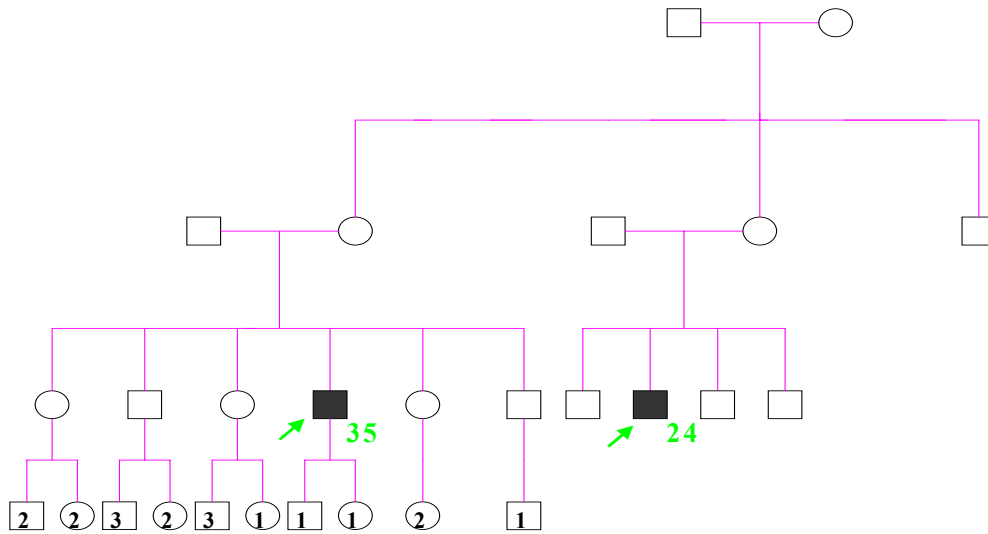

Fig. 1: The family tree of two maternal cousins suffered from LHON caused by G 11778 A mutations.

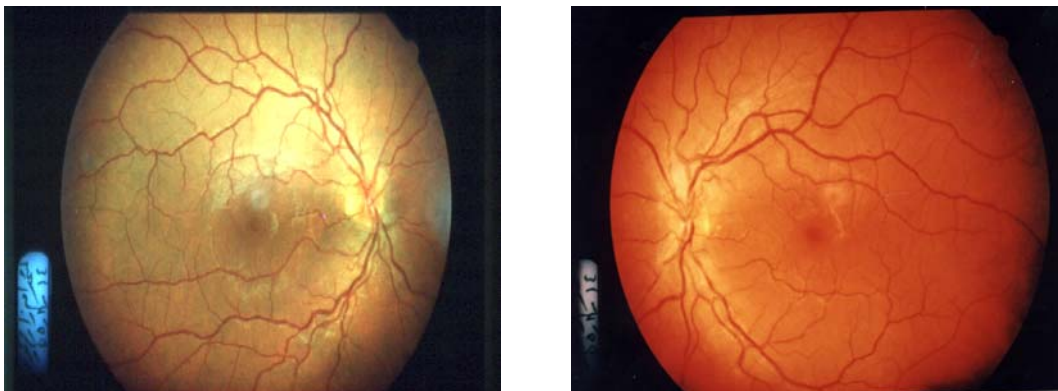

Fig. 2: Fundoscopic images of the LHON proband in its acute phase

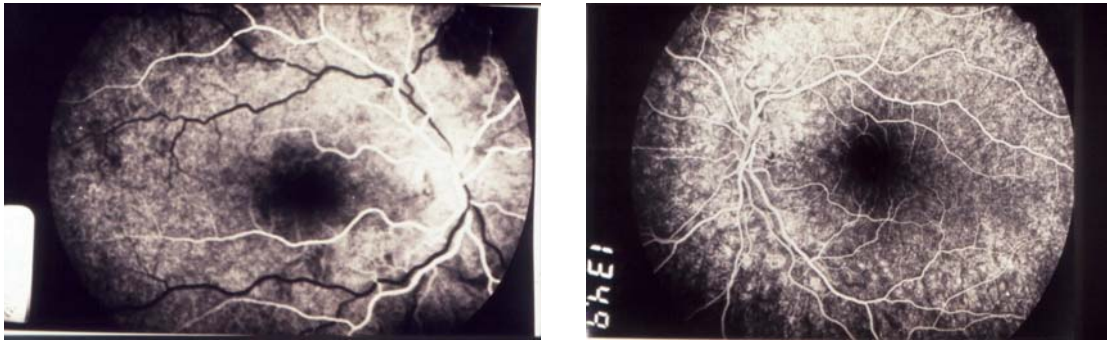

Fig. 3: Angiographic images of the proband. No leakage of fluorescence is observable in the images

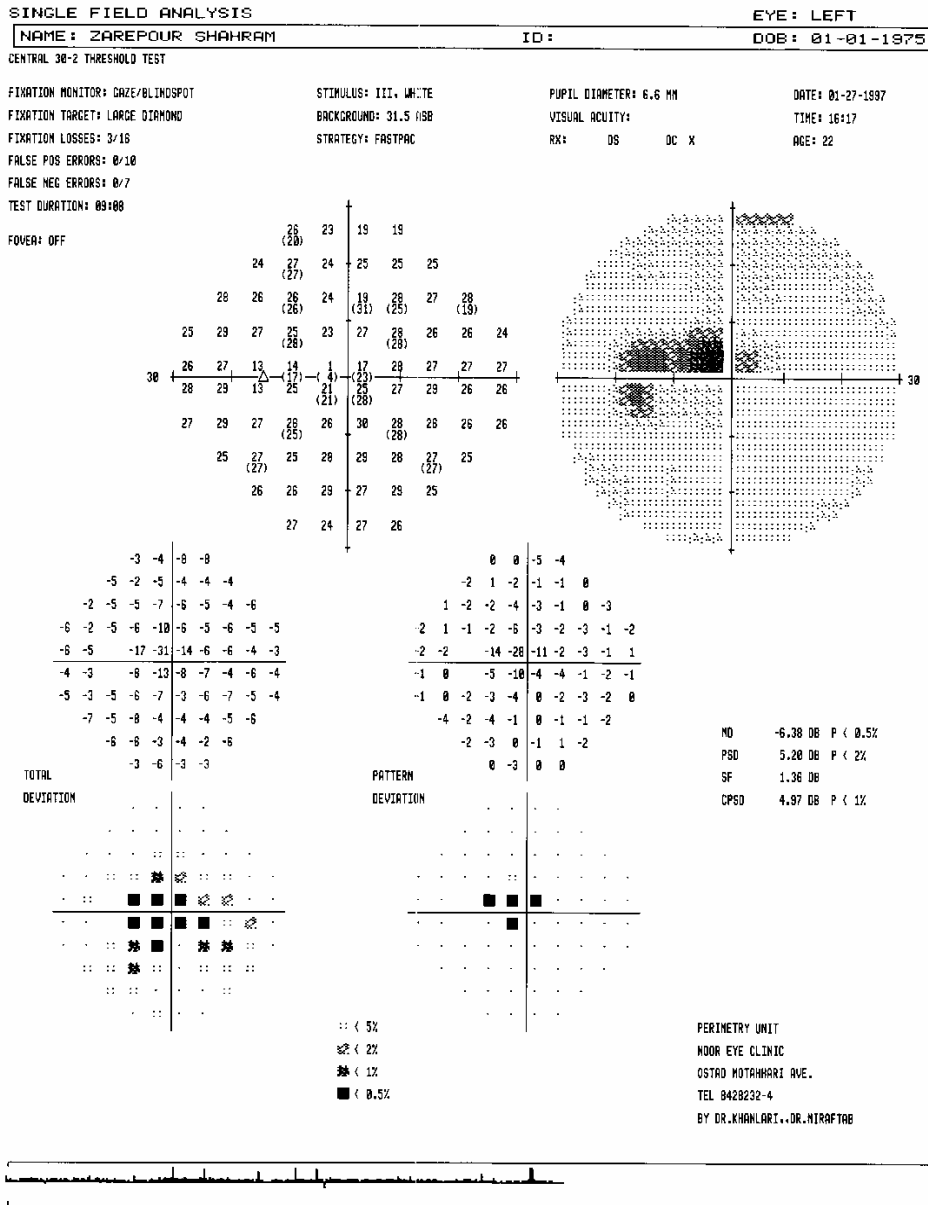

Fig. 4: The first perimetry of the proband showing cecocentral scotoma in left eye

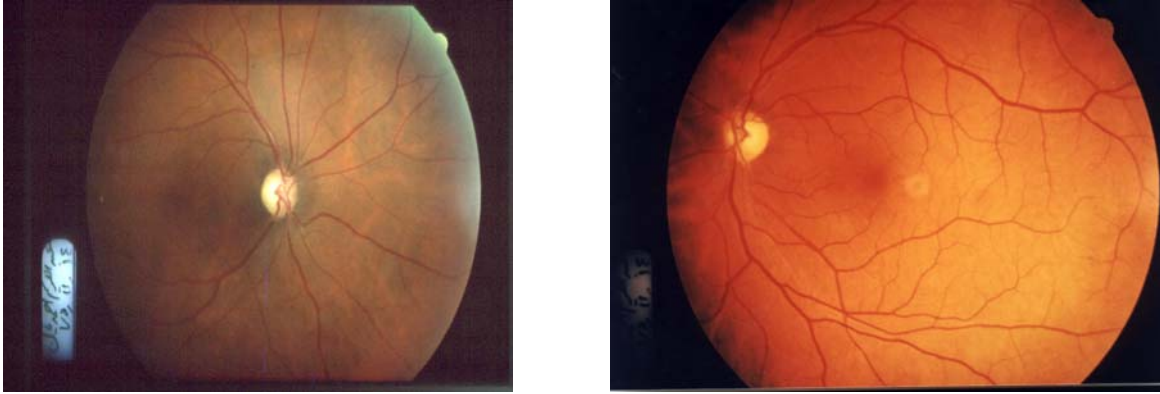

Fig. 5: Fundoscopic images of the proband's maternal cousin himself suffering from LHON

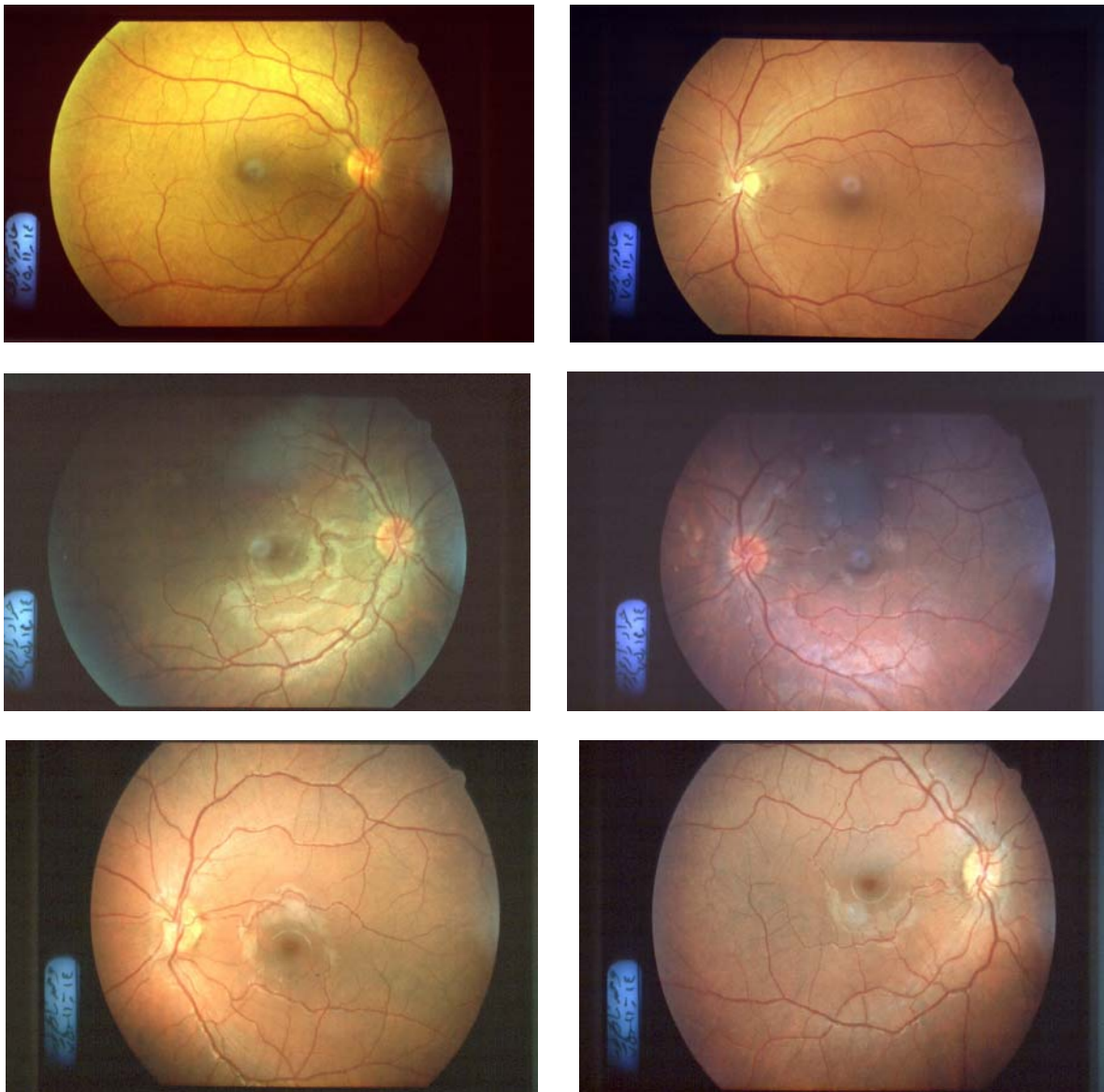

Fig. 6: Fundoscopic images of the proband's mother and brothers

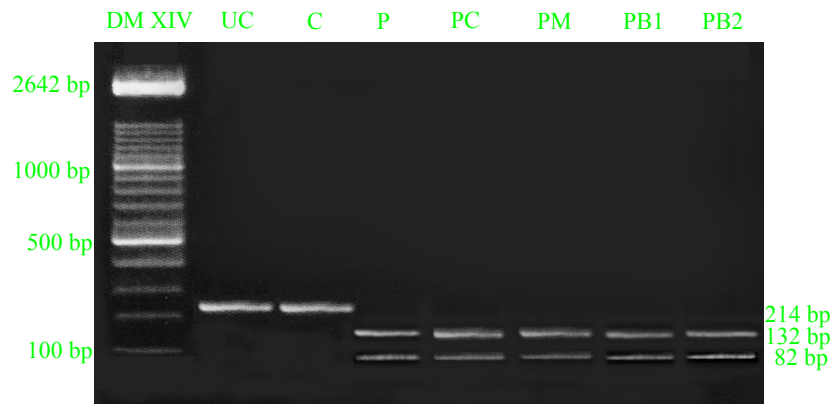

Fig. 7: PCR-RFLP analysis of the G11778A mutation for the first family. Electrophoresis has been done using 1.5% agarose gel stained with ethidium bromide. UC: Uncut DNA, C: Control, P: Proband, PC: Proband's cousin, PM: Proband's mother, PB: Proband's brothers.

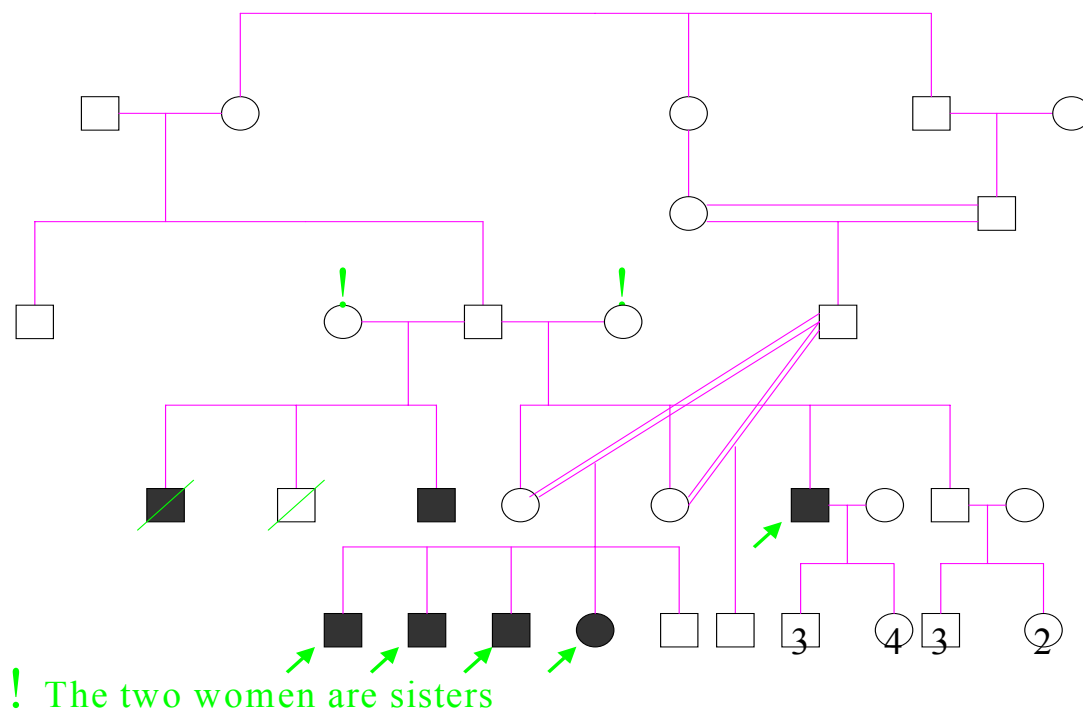

Fig. 8: LHON pedigree of three brothers, their sister, maternal uncle and two half maternal uncles with G 11778 A mutation

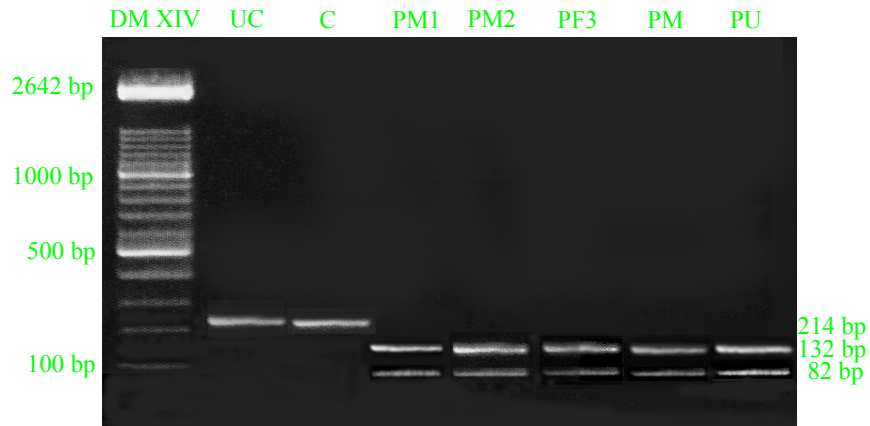

Fig. 9: PCR-RFLP analysis of the G11778A mutation for the second family. Electrophoresis has been done using 1.5% agarose gel stained with Ethidium Bromide. UC: Uncut DNA, C: Control, PM1 and PM2: Two affected brothers, PF3: The affected sister, PM: The mother of family, PU: Proband's uncle

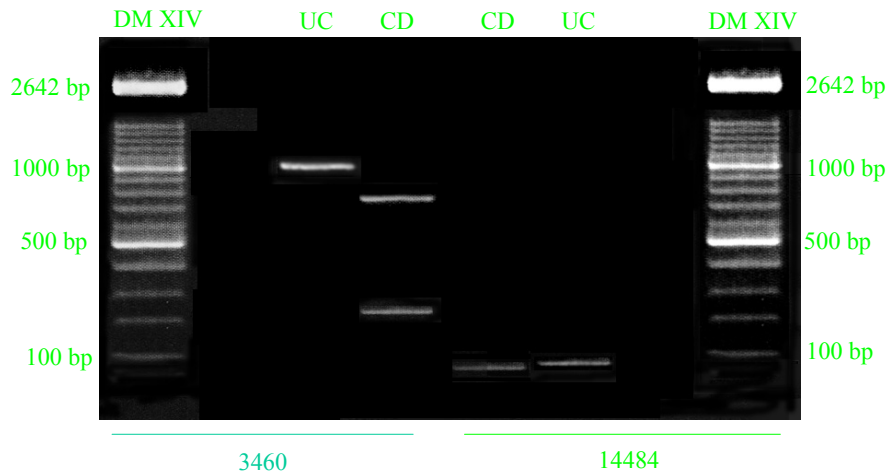

Fig. 10: PCR-RFLP analysis of G3460A and T14484C mutations. UC: Uncut DNA, CD: Control DNA

Discussion

According to this investigation, it seems that the pattern of LHON occurrence in Iran conforms to its worldwide characteristics. In this pattern, LHON has incomplete penetrance and the majority of LHON patients carry the G11778A mutation (14). Furthermore, the Male/Female Ratio of LHON occurrence is 5 to 1 (Male Predominance).

In the small sample of this research, calculation of LHON penetrance, caused by G11778A,

produced the values of 44% and 6% for males and females, respectively; moreover, the total penetrance was calculated to be 24%. The respected values were half of the corresponding values in European population (15).

Male/Female ratio proved to be 80%, which was equal to this value in European population and at the same time inside the extremes of this value in Asian population (58-90%).

The reason for incomplete penetrance and male predominance of LHON has been a matter of

controversy among the pioneers of this discipline and they have posed some hypotheses including the role of additional x-linked visual loss susceptibility locus, impaired mitochondrial respiratory chain activity, mtDNA heteroplasmy, environmental factors and autoimmunity (2). Assuming that the primary defect of LHON mutations is an inhibition of the electron transport chain, and then the pathophysiological basis of the disease might either be chronic energy deficiency or increased ROS generation due to the redirection of electrons from complex I and CoQ₁₀ to molecular oxygen. If increased ROS production and oxidative stress have a role in LHON, then this might contribute to the pathology of LHON in two ways. It is possible that chronic oxidative stress to the retinal ganglion cells and optic nerve might damage the mtDNA and degrade mitochondrial function to such an extent that ultimately the neuronal mtPTP is activated and the cells undergo a wave of programmed cell death. Such a model is attractive because it explains how a chronic disease could result in a sudden onset of symptoms with a precipitous course (11). Alternatively, the increased mitochondrial production of ROS might inactivate the vasodilator NO, resulting in chronic vasoconstriction, ischemia, and death of the retinal ganglion cells. A common set of preclinical findings in LHON families includes microangiopathy, retinal vessel telangiectasias, and tortuous vessels, consistent with LHON being due to a retinal vasculopathy. NO is a natural vasodilator, and it is acutely sensitive to inactivation by ROS (10). If the LHON mutations inhibit the electron transport chain and increase mitochondrial ROS production, then it is possible that these ROS chronically deplete the retinal vascular NO, causing vasoconstriction and ultimately resulting in the spasmodic constriction of the retinal blood vessels, depriving the retinal ganglia cells of oxygen and nutrients. This would lead to ischemia and neuronal death. Thus sudden onset of vision loss would be envisioned as a form of a retinal stroke. While it will be diffi-

cult to define the pathophysiology of mitochondrial ophthalmologic disease in human studies, it is likely that more progress will be made using mouse models for mitochondrial disease. If LHON is the result of increased oxidative stress, then mice lacking mitochondrial antioxidant defenses should be more prone to ophthalmologic decline.

Acknowledgments

This study was supported partly by Iran TWAS chapter based at ISMO in Tehran.

References

1. Wallace DC, Singh G, Lott MT (1988). Mitochondrial DNA mutation associated with Leber's hereditary optic neuropathy, *Science*, 242(4884): 1427-30.
2. Chalmers RM, Schapira AH (1999). Clinical, biochemical and molecular genetic features of Leber's hereditary optic neuropathy, *Biochim Biophys Acta*, 1410(2): 147-58.
3. Man PY, Turnbull DM, Chinnery PF (2002). Leber hereditary optic neuropathy. *J Med Genet*, 39(3): 162-9.
4. Howell N (1998). Leber hereditary optic neuropathy: respiratory chain dysfunction and degeneration of the optic nerve. *Vision Res*, 38(10): 1495-504.
5. Carelli V, Ross-Cisneros FN, Sadun AA (2002). Optic nerve degeneration and mitochondrial dysfunction: genetic and acquired optic neuropathies. *Neurochemistry International*, 40: 573-584.
6. Emory Genetics Laboratory (2002) Leber's Hereditary Optic Neuropathy (LHON). Available at: <http://www.emory.edu/WHSC/GENETICS/CSLAB/dna/lebers.htm>
7. Graeber MB, Ulrich M (1998). Recent developments in the molecular genetics of mitochondrial disorders. *Journal of the Neurological Sciences*, 153: 251-63.

8. Howell N, Bindoff LA, McCullough DA (1991). Leber hereditary optic neuropathy: identification of the same mitochondrial ND1 mutation in six pedigrees. *Am J Hum Genet*, 49: 939-50.
9. [Huoponen K, Vilkki J, Aula P \(1991\). A new mtDNA mutation associated with Leber hereditary optic neuroretinopathy. *Am J Hum Genet*, 48: 1147-53.](#)
10. [Mackey D, Howell N \(1992\). A variant of Leber hereditary optic neuropathy characterized by recovery of vision and by an unusual mitochondrial genetic etiology. *Am J Hum Genet*, 51: 1218-28.](#)
11. Scriver CR, Beaudet AL, Sly WS, Valle D (2001). *The metabolic and molecular bases of inherited disease*. 8th ed., McGraw-Hill, New York.
12. Bidooki SK (1997). *Ph.D. Thesis: Investigation of abnormal DNA in Human Diseases*, The University of Newcastle upon Tyne.
13. [McPherson, MJ, Hames BD, Taylor GR \(1998\). *PCR 2: A practical approach*, Oxford University Press Inc, New York.](#)
14. [Mashima Y, Hiida Y, Oguchi Y \(1993\). High frequency of mutations at position 11778 in mitochondrial ND4 gene in Japanese families with Leber's hereditary optic neuropathy. *Hum Genet*, 92: 101-2.](#)
15. [Wallace DC, Brown MD, Lott MT \(1999\). Mitochondrial DNA variation in human evolution and disease. *Gene Sep*, 238\(1\): 211-30.](#)