

基于邻居信息交换的组播快速切换算法^{*}

张 晖¹⁺, 张宏科²

¹(中国电子技术标准化研究所,北京 100007)

²(北京交通大学 电子信息工程学院,北京 100044)

Multicast Fast Handover Algorithm Based on Neighbor Information Exchange

ZHANG Hui¹⁺, ZHANG Hong-Ke²

¹(China Electronics Standardization Institute, Beijing 100007, China)

²(School of Electronics and Information Engineering, Beijing Jiaotong University, Beijing 100044, China)

+ Corresponding author: E-mail: zh506@sohu.com, http://www.cesi.ac.cn

Zhang H, Zhang HK. Multicast fast handover algorithm based on neighbor information exchange. *Journal of Software*, 2008,19(10):2648-2658. <http://www.jos.org.cn/1000-9825/19/2648.htm>

Abstract: The handover latency and the packet loss rate are important criterions that determine if the mobile multicast algorithm could adapt to real-time multicast appliances. This paper proposes a multicast fast handover algorithm based on neighbor hood information exchange (M-FMIPv6/NIE). Before L2 trigger event occurs, M-FMIPv6/NIE can configure new care-of-address (nCoA) and request new access routers (AR) to join multicast tree. The performance analysis and simulation results indicate that, the multicast service disruption time of M-FMIPv6/NIE is less than that of existing multicast fast handover algorithms and it has good performance in buffer size and packet loss rate.

Key words: mobile multicast; fast handover; L2 trigger; movement model

摘 要: 切换延迟和丢包率是决定移动组播算法是否能够满足实时性组播应用要求的重要指标.提出了一种基于邻居信息交换的组播快速切换算法 M-FMIPv6/NIE.在二层触发器事件发生之前,通过邻居接入路由器之间定时的信息交换,可以提前进行新转交地址的配置和请求加入组播树等操作.性能分析和仿真结果表明,M-FMIPv6/NIE 的组播服务中断时间小于现有的组播快速切换算法,并且在缓存数量和丢包率等方面也具有较佳的性能.

关键词: 移动组播;快速切换;二层触发器;移动模型

中图法分类号: TP393 文献标识码: A

1 Introduction

Now, the most basic mobile handover method in the wireless IPv6 network is to directly use MIPv6^[1] protocol, but its high handover delay and high packet loss rate is not applicable to the real time applications due to its

* Supported by the National Natural Science Foundation of China under Grant Nos.60473001, 60573001 (国家自然科学基金)

Received 2006-10-26; Accepted 2007-06-29

sensitivity to time. For this feature, some solutions for optimizing handover performance are proposed, including Fast Handovers for Mobile IPv6 (FMIPv6)^[2] and Hierarchical Mobile IPv6 (HMIPv6)^[3] protocol, they have become the standards for IETF unicast mobile management. As the extensions of the unicast protocol, the Seamless Multicast Handover in a Hierarchical Mobile IPv6 environment (M-HMIPv6)^[4] and the multicast fast handover protocol for Mobile IPv6 in the fast handovers environment (M-FMIPv6)^[5] are proposed. Although these extensions reduce the multicast service disruption time of mobile node (MN) to some extent during handover process, they have some problems and are difficult to be adapted for practical requirement. Based on the analysis on existing problems, this paper proposes a novel multicast mobility management mechanism, named as *Multicast Fast Handover Algorithm based on Neighbor Hood Information Exchange* (M-FMIPv6/NIE). This is a modification and extension of the FMIPv6 protocol. Before L2 trigger event happens, M-FMIPv6/NIE can configure nCoA and request new ARs to join multicast tree, so it radically reduces multicast service disruption time. During the handover process, M-FMIPv6/NIE also uses the tunnel and buffering mechanism to reduce multicast packet loss as much as possible. The performance analysis with movement model and simulation results indicate that compared with the existing algorithms, the M-FMIPv6/NIE has better performance in the aspect of the multicast service disruption time and multicast packet loss rate.

2 Existing Fast Mobile Multicast Solutions and Their Problems

Some studies aim at the multicast fast handover process in mobile network, most of which are modification and multicast extensions to unicast fast handover and do not depend on multicast routing protocol.

M-HMIPv6^[4] extends the notion of Mobility Anchor Points (MAP) in HMIPv6 to the multicast MAP (M-MAP). M-HMIPv6 specifies that after handover, MN uses the tunnel to send MLD Membership Report message to their M-MAP node, and its on-link CoA is used as source address of the message, so M-MAP can send multicast traffic to MN through the tunnel. The main problems of M-HMIPv6 are the following: after MN's handover is accomplished, it begins to transfer multicast traffic through the tunnel from M-MAP node. In addition, after the L2 handover is accomplished, MN also needs to execute configuration of nCoA, which will consume too much time.

Although FMIPv6 deals with unicast case, it can be used for fast handover of multicast session after simple extension. Similar to FMIPv6, M-FMIPv6^[5] uses L2 trigger to obtain the event of imminent handover, and can anticipate the new subnet prefix information from the link layer address of new access point. It could configure the new foreign care-of-address in advance. Before MN attaches new subnet, by exchanging multicast information between previous access router (PAR) and new access router (NAR), M-FMIPv6 could enable NAR to know the current multicast state of MN and join the corresponding multicast tree in advance. Through this process, after fast handover is accomplished, MN could receive multicast data flow from NAR.

Reference [6] proposes FMIPv6 multicast handover extension mechanism based on flow tunneling and buffering (M-FMIPv6/FTB), it is an improvement based on M-FMIPv6. Through twofold mode, it can realize seamless multicast handover. Firstly, before MN actually moves to new subnet, NAR can receive the interested multicast flow from PAR through the tunnel. Because the tunneled multicast packets have been encapsulated by NAR before forwarding to the wireless link, it eliminates the additional load caused by packet encapsulation on the wireless interface of NAR and MN. Secondly, during the period that MN loses connection because of link layer handover, NAR buffers the multicast data flow which have been received through the tunnel. Once MN attaches new access point and notifies NAR through FNA message, the buffered data packets are immediately forwarded to MN by NAR.

Based on the FMIPv6 algorithm, Ref.[7] proposes fast multicast handoff based on hierarchical mobile

multicast architecture (FHMM). For the multicast maintenance overhead caused by frequent handover, FHMM manages multicast with the hierarchical management mode and shields the location changes of the members inside the domain to exterior. It guarantees the backbone stability of multicast distribution tree and reduces the overhead of multicast protocol. Through proper multicast extension of FMIPv6 protocol, FHMM enables the network to process multicast before the node actually moves to new subnet.

The mechanisms proposed by Ref.[5–7] are the multicast extensions based on FMIPv6 and follow the main signaling flow of FMIPv6 protocol. So these mechanisms have small handover delay theoretically, but in essence, they inherit the shortcoming of that FMIPv6 heavily depends on the L2 trigger and mobile anticipation^[8].

Just through the specific L2 trigger event, FMIPv6 protocol could know the link layer handover information and subnet prefix information of NAR from PAR in advance. FMIPv6 uses the pre-configured address method to effectively reduce the delay for nCoA configuration and duplicate address detection (DAD), so it greatly improves the whole performance of handover. However, there are some difficulties in timely utilization of the link layer handover information, namely it is an unresolved problem to understand the timing when the link layer informs FMIPv6 protocol to begin handover. As the link-specific event, L2 trigger depends on the used link layer technology. Due to the unpredictable channel condition, the time when L2 trigger is generated can be different even for the same link layer interface. In addition, L2 triggers are not specified by the standards organizations at all.

When beginning handover, it is possible that MN loses connection with PAR suddenly because of link signal quality degradation and will lead to anticipation failure. At this time, the MN has to revert to normal MIPv6 or reactive FMIPv6 handover and will suffer more packet loss and handover latency. The root cause of the above problems in FMIPv6 is that the generation timing of L2 trigger event cannot be accurately identified. After the network layer receives L2 trigger event, it can not be guaranteed that MN can be connected to PAR long enough to be able to send and receive all FMIPv6 messages, so it leads to anticipation failure or disruption of the protocol execution.

In multicast case, once anticipation fails, MN is compelled to initiate the multicast join request after attaching new subnet. Since the disruption from multicast routing protocol convergence may last many seconds, the multicast service disruption time will be unpredictably increased. So the key to realizing multicast fast handover is that MN can notify NAR to join the corresponding multicast group as early as possible before handover.

3 Multicast Fast Handover Algorithm Based on Neighbor Hood Information Exchange

M-FMIPv6/NIE is based on the mobile multicast remote subscription algorithm, meanwhile, through proper improvement and multicast extension to FMIPv6 protocol, it enables new AR to request joining multicast group before L2 trigger event and actual handover.

3.1 Neighbor hood information exchange protocol

First, this paper proposes the Neighbor Hood Information Exchange Protocol (NIEP), which is used to regularly exchange information relative to handover among ARs adjacent to current AR of MN. The geographical neighbor hood relation between ARs can be configured by the administrator during the network deployment phase and is saved into a corresponding neighbor list. The information exchange content includes: (1) link layer information, used to discover wireless access network feature of other AR. Generally it includes link layer ID (L2ID) of the wireless base station (BS) connecting to this AR, type of wireless access technology, and BS working frequency etc; (2) network layer information, including AR's network layer address, its prefix, network load, etc, these information is similar to the information obtained by candidate access router discovery (CARD) protocol^[9]; (3) multicast information, including whether this AR supports multicast, all multicast group information it saved if

it supports multicast. Each information content has different update period according to actual requirements, e.g. because the network topology is relatively stable, update interval of link layer and network layer information can be longer; for multicast information, because the joining and leaving of multicast group members may be frequent, its update interval should be set to be smaller.

3.2 M-FMIPv6/NIE protocol operation

Figure 1 indicates the signaling operation in M-FMIPv6/NIE algorithm, the MAO in the bracket of the message indicates *Multicast Address Option* included in this message. *Multicast Address Option* contained in the IPv6 *Mobility Header* is defined similar to that for M-FMIPv6^[5]. When MN receives multicast traffic from PAR in the current subnet, PAR uses the NIEP protocol to exchange neighbor hood information with multiple geographically adjacent ARs. PAR will save the information about adjacent ARs obtained through NIEP protocol into a corresponding list.

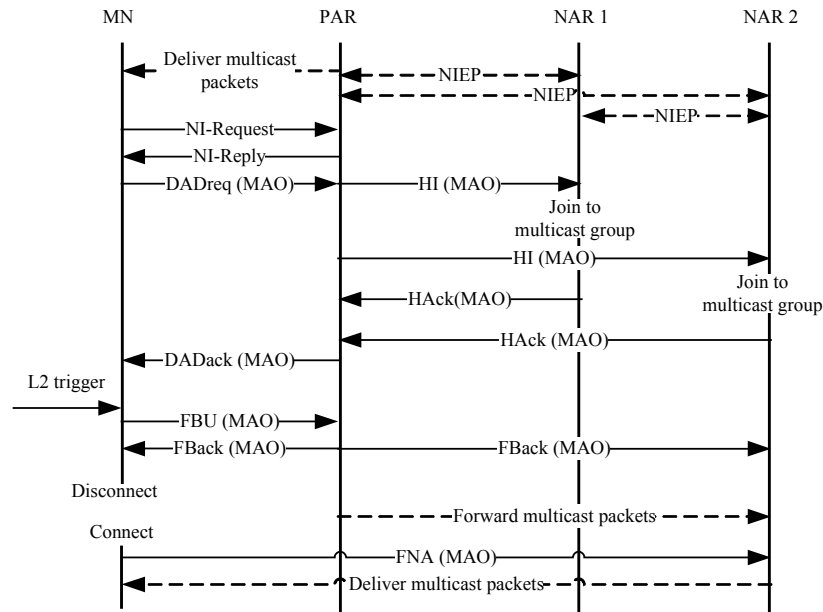

Fig.1 M-FMIPv6/NIE protocol operation

MN will send neighbor hood information request (NI-Request) message to PAR at proper time to request the information about adjacent ARs. Through the reply information in neighbor hood information reply (NI-Reply) message, MN can know the link layer information and network layer information of its every adjacent AR, and multicast information of this AR. Based on it, MN can generate different anticipated nCoAs and send them to PAR through duplicate address detection request (DADreq) message. DADreq message also carries with *Multicast Address Option* which denotes the interested multicast service of MN. After receiving DADreq message, for each different adjacent subnet, PAR will encapsulate the nCoA and *Multicast Address Option* of the corresponding subnet into HI message and forward it to the corresponding adjacent AR. This adjacent AR will execute DAD process to verify whether nCoA is valid. Meanwhile, according to *Multicast Address Option* in the HI message, AR will initiate multicast join request to the multicast upstream router. After executing above operation, each candidate AR replies to PAR with HAck message to confirm the availability of nCoA and the completion of multicast join operation. PAR will use the DAD acknowledgement (DADack) message to confirm the configuration process of nCoA and completion of the multicast join process to MN.

Through NI-Request and NI-Reply message, MN gets the information about multiple candidate ARs possibly to attach to. In the subsequent DADreq message, MN initiates the configuration request for nCoA to each candidate AR. Meanwhile, each HI message includes *Multicast Address Option*, which will notify each candidate AR to join multicast group and establish corresponding multicast state in advance.

Because the time-consuming nCoA configuration process and the multicast join process have been completed in advance, the job that waits for MN to do will be very simple after receiving the L2 trigger event. It only needs to send the FBU message including *Multicast Address Option* to inform PAR that it will initiate handover and require PAR to buffer the received corresponding multicast data flow. When PAR is buffering multicast data flow, it sends FBack message with *Multicast Address Option* to inform MN that buffering is successful and to inform NAR that NAR can send tunnel join request to PAR. The detailed buffering and tunneling process will be described in the Section 4.3.

After completing link layer handover and attaching to new subnet, MN instantly sends FNA message with *Multicast Address Option* to NAR, which will inform NAR of MN's reaching and request NAR to forward the buffered multicast data flow and the data received from PAR to MN. Once NAR completes the operation of joining multicast tree requested by MN before handover, it can forward new multicast data flow to this MN. Till now MN has completed all multicast handover process.

Although other ARs adjacent to PAR have joined the multicast distribution tree, MN does not actually move to the subnets of these ARs. If the multicast group which is requested to join by MN does not have other receivers in this AR, to avoid maintaining multicast group state for a long time unnecessarily, a timer can be set to prune it from the multicast tree. Although M-FMIPv6/NIE has more signaling load than other multicast fast handover algorithms, because these signaling messages execute in the wired part of network, it will not have great influence on the network performance. Compared with its performance improvement in the great reduction of multicast service disruption time, the increased signaling load in the network is acceptable.

To reduce signaling load and multicast maintenance overhead, the movement forecast model could be combined with M-FMIPv6/NIE. By forecasting NAR which MN will attach to, M-FMIPv6/NIE will send HI message with MAO option to this AR instead of all adjacent ARs. Due to the limitation of the paper length, we would not introduce it further.

4 Handover Performance Analysis of M-FMIPv6/NIE

4.1 Movement model based on residence time

Reference [10] has presented a kind of two-dimensional hexagonal random walk model in Personal Communication Services (PCS) system. Based on this, considering the characteristic that one subnet in mobile network environment is usually overlaid with some wireless access points (AP), we present a modified two-dimensional layered mesh random walk model which could adapt to mobile network to calculate probability density function (PDF) of subnet residence time.

Figure 2 shows a 4-layer subnet model. The AP area at the center of subnet is called layer 0. The AP areas which are enclosed by a dashed line form different layers. The layers are called layer 1, layer 2 and layer 3 from inside to outside. We assume that MN resides in an AP area for a period and moves to one of its four neighbors with equal probability. We divide AP areas in a subnet into several different types. An AP area type is of the form $\langle x, y \rangle$, where x indicates that this AP area is in layer x and y indicates that it is the $y+1^{\text{st}}$ type in layer x . The AP areas which have the same type will have the same traffic flow pattern because they are at the symmetrical positions on the mesh subnet. In the two-dimensional layered mesh random walk model, the number of layers in a subnet is presented by

n , the transient state (x,y) presents that MN is in one of the AP areas of type $\langle x,y \rangle$, the state $(n,0)$ is absorbing state which presents that MN moves out of the subnet from state $(n-1,j)$, where $0 \leq j < n-1$. In the random walk model we presented, the number of all states is $S=(n^2-n)/2+2$, where $n \geq 1$. The transition matrix of this random walk model is $S \times S$ matrix which could be denoted by $P=(p_{(x_1,y_1)(x_2,y_2)})$ where $p_{(x_1,y_1)(x_2,y_2)}$ represents the probability that MN moves from state (x_1,y_1) to state (x_2,y_2) in one step. Figure 3 shows a state diagram of the random walk model for 4-layer subnet and its 8×8 state transition matrix is as follows

$$P = \begin{pmatrix} 0 & 1 & 0 & 0 & 0 & 0 & 0 & 0 \\ 1/4 & 0 & 1/4 & 1/2 & 0 & 0 & 0 & 0 \\ 0 & 1/4 & 0 & 0 & 1/4 & 1/4 & 1/4 & 0 \\ 0 & 1/2 & 0 & 0 & 0 & 1/4 & 1/4 & 0 \\ 0 & 0 & 1/4 & 0 & 0 & 0 & 0 & 3/4 \\ 0 & 0 & 1/4 & 1/4 & 0 & 0 & 0 & 1/2 \\ 0 & 0 & 1/4 & 1/4 & 0 & 0 & 0 & 1/2 \\ 0 & 0 & 0 & 0 & 0 & 0 & 0 & 1 \end{pmatrix} \quad (1)$$

We could use Chapman-Kolmogorov equation to compute the K steps transition matrix that MN moves from an AP area type to another.

$$P^{(k)} = \begin{cases} P, & k=1 \\ P \times P^{(k-1)}, & k>1 \end{cases} \quad (2)$$

Each element $p_{(x_1,y_1)(x_2,y_2)}^{(k)}$ in the K steps transition matrix is the probability that MN moves from state (x_1,y_1) to state (x_2,y_2) with exact k steps random walk.

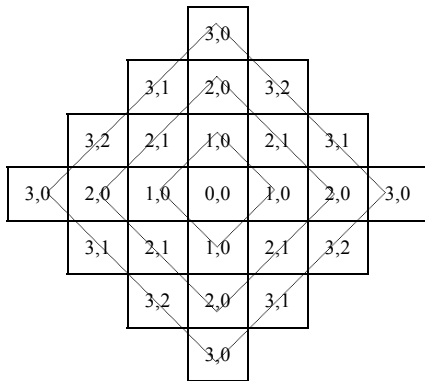

Fig.2 Four layers subnet model

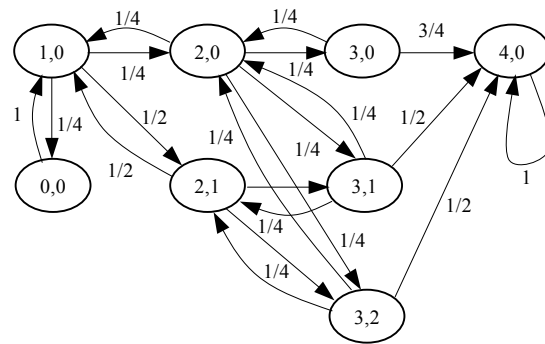

Fig.3 State diagram

Definition 1. We define $p_{k,(x,y)(n-1,j)(n,0)}$ as the probability that MN initially resides at $\langle x,y \rangle$ AP area, in the case of moving into $\langle n-1,j \rangle$ AP area at exactly $(k-1)^{st}$ step, and moves out of the subnet at exactly the k^{st} step.

Let t_s denote the subnet residence time of MN and t_p denote the AP area residence time of MN. They are both independently and identically distributed random variables. Similar to Refs.[4,5], this paper regards the subnet residence time of MN t_s as a threshold. Once the subnet residence time exceeds the threshold, MN will move out of the subnet. Then

$$p_{k,(x,y)(n-1,j)(n,0)} = \begin{cases} P(t_1 > t_s), & k=1 \\ P\left(\sum_{i=1}^k t_i > t_s \mid \sum_{i=1}^{k-1} t_i < t_s\right), & k>1 \end{cases} \quad (3)$$

and by

$$P\left(\sum_{i=1}^{k-1} t_i < t_s < \sum_{i=1}^k t_i\right) = P\left(\sum_{i=1}^k t_i < t_s\right) - P\left(\sum_{i=1}^{k-1} t_i < t_s\right) \tag{4}$$

The following equation could be deduced:

$$P_{k,(x,y)(n-1,j)(n,0)} = \begin{cases} P_{(x,y)(n,0)}, & k = 1 \\ P_{(x,y)(n,0)} - P_{(x,y)(n,0)}^{(k-1)}, & k > 1 \end{cases} \tag{5}$$

Assume that $f_s(t)$ and $f_p(t)$ are the density function of t_s and t_p , respectively. We could derive the subnet residence time distribution from the AP area residence time distribution. Suppose that MN has visited k AP areas in a subnet and MN resides at i^{th} AP area for a period t_i . Then its residence time in the subnet at present is $t_s^k = t_1 + t_2 + \dots + t_k$. The probability density function of t_s^k could be denoted by $f_s^{(k)}(t)$. The Laplace transform for $f_s^{(k)}(t)$ is as follows

$$f_s^{(k)*}(s) = E(e^{-st_s}) = \prod_{j=1}^k E(e^{-st_j}) = [f_p^*(s)]^k \tag{6}$$

where $f_p^*(s)$ is the Laplace transform of $f_p(t)$.

Let $q_{(n-1,j)}$ be the probability that MN moves into the subnet through $\langle n-1,j \rangle$ type AP area at the first step. For a n -layer subnet, the subnet residence time density function is

$$f_s(t) = \sum_{k=1}^{\infty} \sum_{y=0}^{n-2} \sum_{j=0}^{n-2} q_{(n-1,y)} P_{k,(n-1,y)(n-1,j)(n,0)} f_s^{(k)}(t) \tag{7}$$

Laplace transform for the above equation, we have

$$f_s^*(s) = \sum_{k=1}^{\infty} \sum_{y=0}^{n-2} \sum_{j=0}^{n-2} q_{(n-1,y)} P_{k,(n-1,y)(n-1,j)(n,0)} [f_p^*(s)]^k \tag{8}$$

Since

$$\frac{df_s^*(s)}{ds} = \frac{d}{ds} \int_0^{\infty} e^{-st} f_s(t) dt = (-1) \int_0^{\infty} e^{-st} t f_s(t) dt \tag{9}$$

We can get expected subnet residence time as follows:

$$E[t_s] = (-1) \frac{df_s^*(s)}{ds} \Big|_{s=0} = - \sum_{k=1}^{\infty} \sum_{y=0}^{n-2} \sum_{j=0}^{n-2} q_{(n-1,y)} P_{k,(n-1,y)(n-1,j)(n,0)} k [f_p^*(0)]^{k-1} \frac{df_p^*(s)}{ds} \Big|_{s=0} \tag{10}$$

4.2 Function expression of handover performance

Definition 2. The Session-to-AP-Mobility-Ratio is the average number of sessions to MN per unit time, divided by the average number of times that MN passes through AP areas per unit time. It is denoted by ρ .

Definition 3. The Session-to-Subnet-Mobility-Ratio is the average number of sessions to MN per unit time, divided by the average number of times that MN passes through subnets per unit time. It is denoted by ω .

Exponential distribution is a special case of Gamma. Most mobile models use exponential distribution for its simplicity. In this paper, we suppose that the AP area residence time of MN has Gamma distribution with mean $E(t_p) = 1/\lambda_p$ and variance ν . The main reason that the Gamma distribution is selected in this paper is that Gamma distribution does not have a specific distribution shape. It could fit to an arbitrary distribution by setting appropriate parameters^[10]. Additionally, the Gamma distribution has a simple Laplace Transform format which simplifies the calculation. The Laplace Transform of a Gamma random variable is expressed as

$$f_p^*(s) = \left(\frac{\gamma \lambda_p}{s + \gamma \lambda_p} \right)^\gamma, \text{ where } \gamma = \frac{1}{\nu \lambda_p^2} \tag{11}$$

The expression of expected subnet residence time could be derived from substituting Eq.(11) into Eq.(10).

Suppose that the expected value of a session time is $E(t_c) = 1/\lambda_c$, then the Session-to-AP-Mobility-Ratio

$\rho = E(t_p)/E(t_c)$. The probability that MN traverses K AP areas in a session time could be derived from Ref.[12]

$$\alpha_p(K) = \begin{cases} 1 - \frac{1}{\rho}[1 - f_p^*(\lambda_c)], & K = 0 \\ \frac{1}{\rho}[1 - f_p^*(\lambda_c)]^2 [f_p^*(\lambda_c)]^{K-1}, & K > 0 \end{cases} \quad (12)$$

Then MN moves across the following average numbers of AP areas in a session time

$$E(N_p) = \sum_{K=0}^{\infty} K \alpha_p(K) \quad (13)$$

By Definition 3, the Session-to-Subnet-Mobility-Ratio is $\omega = E(t_s)/E(t_c)$. Similar to the above analysis, the probability that MN traverses K subnets in a session time could be derived from Ref.[11] as follows

$$\alpha_s(K) = \begin{cases} 1 - \frac{1}{\omega}[1 - f_s^*(\lambda_c)], & K = 0 \\ \frac{1}{\omega}[1 - f_s^*(\lambda_c)]^2 [f_s^*(\lambda_c)]^{K-1}, & K > 0 \end{cases} \quad (14)$$

Then MN moves across the following average numbers of subnets in a session time

$$E(N_s) = \sum_{K=0}^{\infty} K \alpha_s(K) \quad (15)$$

4.3 Handover latency of M-FMIPv6/NIE

In this section, we analyze the handover latency of M-FMIPv6/NIE algorithm. For simplicity, Fig.4 presents only the part relative to multicast service disruption time, i.e. the part starts with FBU message delivery. In the figure, D_{FBU-L2} presents the latency between FBU message transmission and L2-down trigger, D_{L2} presents the link layer handover latency, t_{AR} presents the packet delivery delay between NAR and PAR in wired path, t_{MN-AR} presents the packet delivery delay between MN and AR in wireless path.

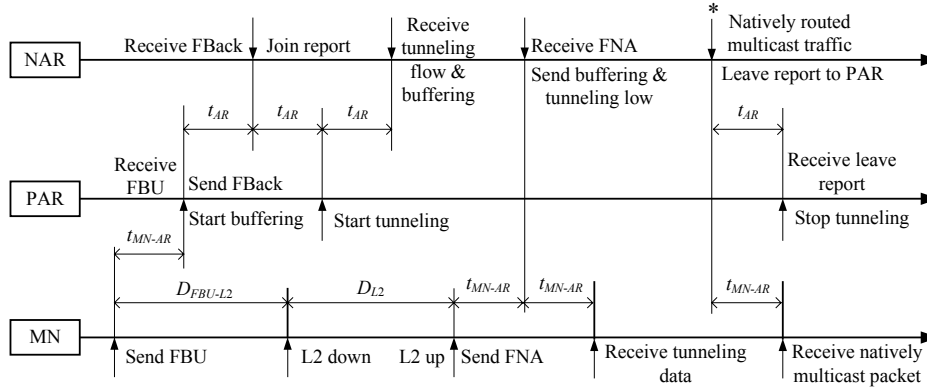

Fig.4 Signaling and packet delivery timing for M-FMIPv6/NIE

In M-FMIPv6/NIE algorithm, after PAR receives FBU message sent by MN, it begins to buffer the corresponding multicast data flow according to *Multicast Address Option* included in FBU message and sends FBack message containing *Multicast Address Option* to MN and NAR. After receiving the FBack message, according to its contained *Multicast Address Option*, NAR sends MLD Join Report message to PAR to request to establish the tunnel between PAR and NAR and forward the multicast data flow to NAR. Through this mode, NAR can receive the data packets buffered by PAR through the tunnel in advance, so it effectively avoids the buffer overflow caused by long multicast data buffering of PAR. If MN does not attach to new subnet yet, NAR will also

need to buffer the multicast packets received from PAR. Once receiving FNA message which is send by MN from new subnet, NAR should instantly forward the buffered multicast packets and the multicast data flow receiving from PAR through the tunnel to MN.

If NAR has joined the corresponding multicast tree and established the multicast state requested by MN, when forwarding natively routed multicast traffic to MN, NAR should send MLD leave report message to PAR to notify it to stop forwarding multicast data flow to NAR. M-FMIPv6/NIE adopts a per flow-based mode proposed by Ref.[6] to establish the tunnel between PAR and NAR, so it eliminates the tunnel convergence problem.

The multicast service disruption time stands for the period from the time when MN cannot receive the multicast data from previous subnet to the time when it could receive the multicast data again from new subnet. From the figure, during each handover process, the multicast service disruption time of MN begins with the time when PAR receives the FBU message and buffers the multicast data flow and ends with the time when MN receives the tunneled multicast data flow from NAR after it moves to new subnet, it is shown as follows

$$D_{Disrupt} = D_{FBU-L2} + D_{L2} + t_{MN-AR} \quad (16)$$

By the results in Section 4.2, we can calculate the expected value of total multicast service disruption time for MN in a multicast session by using the M-FMIPv6/NIE algorithm

$$D_{M-FMIPv6/NIE} = (E(N_p) - E(N_s))D_{L2} + E(N_s)(D_{FBU-L2} + D_{L2} + t_{MN-AR}) \quad (17)$$

where $E(N_p)$ and $E(N_s)$ are the average numbers of AP areas and subnets which MN moves across in a session.

During handover, the buffer size required by M-FMIPv6/NIE consists of two parts: the PAR buffering part and the NAR buffering part, respectively. The total buffer size required by M-FMIPv6/NIE in a multicast session is

$$B_{M-FMIPv6/NIE} = \lambda E(N_s) \cdot 2t_{AR} + \lambda E(N_s)(D_{FBU-L2} + D_{L2} - 3t_{AR}) \quad (18)$$

where λ is the average multicast packet arrival rate.

5 Simulation Results

We extend FHMIP module in NS2 to compare M-FMIPv6/NIE algorithm with other algorithms in performance. In simulation procedure, MN produces L2 trigger event by monitoring the received IEEE802.11b WLAN beacon signals power value. When received power level is below a pre-selected threshold, *L2_Quality_Crosses_Threshold* (LQCT) or *L2_Going_Down* (LGD) triggers are delivered. The selection of thresholds influences the exact signaling timing. In our implementation, the occurrence of LQCT trigger indicates that the AP discovery procedure has finished and MN should begin the exchange of RtSolPr and PrRtAdv messages with PAR. Similarly, the LGD trigger indicates that FBU message must be transmitted immediately. The *L2_Down* and *L2_Up* triggers correspond to the cases that MN is moving into the scan phase or has established a link layer connection with a new AP.

Table 1 Main simulation parameters and default values

Parameter	Default value	Parameter	Default value
Simulation duration time	300 s	MLD query response interval	5 s
Network topology	10×10 subnets	Distance between ARs	100 m
<i>L2_Quality_Crosses_Threshold</i>	-69.9 dBm	CBR streaming video bit rate	100 Kbps
Handover anticipation power threshold	-70 dBm	Multicast packet generation rate	64 packets/s
MLD query interval	10 s	Multicast packet size	200 bytes

In our simulation environment, the power overlay range of AP is 71m. For simplicity, we suppose that all ARs support multicast and each AR is the multicast router in its subnet. During the simulation procedure, there is one multicast group and only one source in the multicast group.

Figure 5 depicts the change of handover anticipation time for different handover anticipation power threshold

values as measured during the FMIPv6-based protocols' execution. As expected, the lower the handover anticipation power threshold the shorter interval of time is for MN to anticipate a handover. The interval is between the time of LGD trigger event (i.e. when MN sends FBU message) and the time of L2-Down trigger event. For FMIPv6-based protocols, a very short interval leads to a great probability of the reactive handover execution of MN. In the time of handover anticipation, M-FMIPv6/NIE only needs to send FBU message and receive FBack message without any other operation that may consume much time. So, from Fig.6, we can see that the handover anticipation time does not influence its performance basically. But for M-FMIPv6 and M-FMIPv6/FTB, if the handover anticipation power threshold is too low and accordingly the handover anticipation time is too short, they wouldn't have enough time to accomplish the operations of nCoA configuration and joining the multicast group in advance.

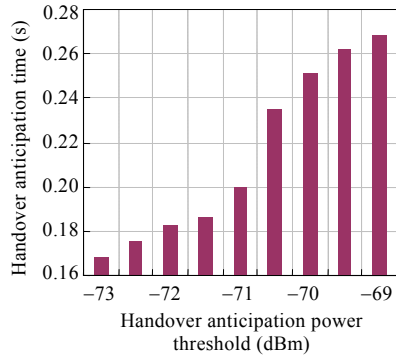

Fig.5 Anticipation time vs. power threshold

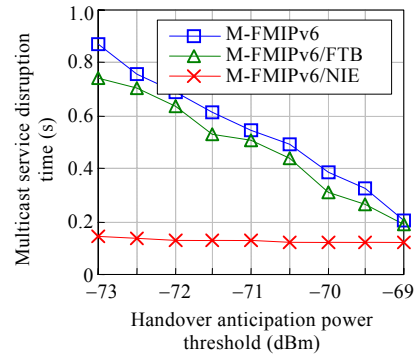

Fig.6 Multicast service disruption time

Figure 7 presents the relation between the speed of MN and the multicast service disruption time. Since the node requests to join the multicast group in advance, M-FMIPv6/NIE could reduce the multicast service disruption time evidently, especially for mobile nodes with high speed. For M-FMIPv6 and M-FMIPv6/FTB, when the speed increases to a certain value, the multicast service disruption time will not be shortened any more, on the contrary, it will increase to some extent. The reason is that at this time the handover anticipation time becomes short and the probability that MN executes reactive handover will increase. So M-FMIPv6/NIE may adapt well to the nodes with high speed and have good performance. From Fig.8 we can see that in M-FMIPv6/NIE MN requires neighbor ARs to join the multicast group before its handover. So M-FMIPv6/NIE has more heavy multicast maintenance overhead.

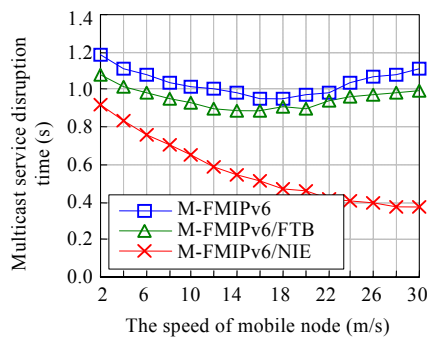

Fig.7 Multicast service disruption time

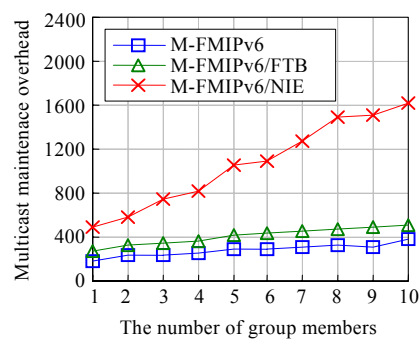

Fig.8 Multicast maintenance overhead

6 Conclusions

In this paper, we have presented a novel multicast fast handover algorithm based on neighbor hood information

exchange M-FMIPv6/NIE. In M-FMIPv6/NIE, by exchanging L2 and L3 information among neighbor ARs on schedule, MN could accomplish nCoA configuration and request joining the multicast group in advance before L2 trigger event. The model analysis and the simulation result show that, M-FMIPv6/NIE could shorten multicast service disruption time effectively and satisfy the requirement of real-time multicast application. Moreover, it has merits of lower multicast packet loss and fewer buffered multicast packets.

References:

- [1] Johnson D, Perkins C, Arkko J. Mobility support in IPv6. IETF RFC 3775, 2004.
- [2] Koodli R. Fast handovers for mobile IPv6. IETF RFC 4068, 2005.
- [3] Soliman H, Castelluccia C, El-Malki K. Hierarchical mobile IPv6 mobility management. IETF RFC 4140, 2005.
- [4] Schmidt T, Waehlich M. Seamless multicast handover in a hierarchical mobile IPv6 environment (M-HMIPv6). IETF Internet Draft, 2005. draft-schmidt-waehlich-mhmip6-04.txt
- [5] Suh K, Suh YJ. Fast multicast protocol for mobile IPv6 in the fast handovers environment. IETF Internet Draft, draft-suh-mipship-fmcast-mip6-00.txt, 2004.
- [6] Leoleis GA, Prezerakos GN. Seamless multicast mobility support using fast MIPv6 extensions. Computer Communications, 2006, doi: 10.1016/j.comcom.2006.07.013
- [7] Wu Q, Wu JP, Xu MW, Cui Y. A Fast multicast handoff based hierarchical mobile multicast architecture. Journal of Software, 2006,17(1):86-95 (in Chinese with English abstract). <http://www.jos.org.cn/1000-9825/17/86.htm>
- [8] Dimopoulou L, Leoleis G, Venieris IS. Fast handover support in a WLAN environment: Challenges and perspectives. IEEE Network, 2005.
- [9] Liebsch M. Candidate access router discovery (CARD). IETF RFC 4066, 2005.
- [10] Akyildiz IF, Lin YB, Lai WR, Chen RJ. A new random walk model for PCS networks. IEEE Journal on Selected Areas in Communications, 2000,18(7):1254-1260.
- [11] Lin YB. Reducing location update cost in a PCS network. ACM/Baltzer Wirelss Networks, 1997,5(1):25-33.

附中文参考文献:

- [7] 吴茜,吴建平,徐明伟,崔勇.基于快速组播切换的分层移动组播体系结构.软件学报,2006,17(1):86-95. <http://www.jos.org.cn/1000-9825/17/86.htm>



ZHANG Hui was born in 1973. He is a Ph.D. at China Electronics Standardization Institute, Beijing. His current research areas are mobile Internet and multicast.



ZHANG Hong-Ke was born in 1957. He is a professor and doctoral supervisor at the School of Electronics and Information Engineering, Beijing Jiaotong University. His research areas are Next Generation Internet and its application.