

Review

A review of pervaporation for product recovery from biomass fermentation processes†

Leland M Vane*

National Risk Management Research Laboratory, Office of Research and Development, US Environmental Protection Agency, Cincinnati, OH 45268, USA

Abstract: Although several separation technologies are technically capable of removing volatile products from fermentation broths, distillation remains the dominant technology. This is especially true for the recovery of biofuels such as ethanol. In this paper, the status of an emerging membrane-based technology, called pervaporation, for this application is reviewed. Several issues and research priorities which will impact the ability of pervaporation to be competitive for biofuel recovery from fermentation systems are identified and discussed. They include: increased energy efficiency; reduction of capital cost for pervaporation systems; longer term trials with actual fermentation broths; optimized integration of pervaporation with fermentor; synergy of performing both alcohol recovery and solvent dehydration by pervaporation with dephlegmation fractional condensation technology; and updated economic analyses of pervaporation at various biofuel production scales. Pervaporation is currently viable for biofuel recovery in a number of situations, but more widespread application will be possible when progress has been made on these issues.

Published in 2005 for SCI by John Wiley & Sons, Ltd.

Keywords: pervaporation; biofuels; product recovery; fermentation

INTRODUCTION

The production of renewable biofuels has been receiving increased attention due to the phase-out of methyl *t*-butyl ether (MTBE) as a fuel oxygenate, the reliance on sometimes problematic sources of fossil fuels, and the effect of non-renewable fossil fuel combustion on the earth's climate. Currently, the conversion of corn to ethanol accounts for the vast majority of liquid biofuels produced in the United States. Only a few decades ago, the ethanol produced from corn contained less energy value than the energy required to produce that ethanol.¹ Over time, however, efficiency gains in the corn-to-ethanol conversion process have reversed this situation.^{1,2} Unfortunately, some of these efficiencies are only possible at the large scale, thereby fueling the drive to large corn-to-ethanol plants. For example, the median capacity of corn-to-ethanol plants under construction in the year 2004 was 40 million gallons per year (MGY) (150 million liters per year—MLY) [Source: BBI International]. This size plant requires 0.4 million metric tons of corn each year.³ During the 2002/2003 corn marketing year in the US, about 2.5 billion gallons (9.5 billion liters) of fuel ethanol were produced from about 920 million bushels of corn (23 billion metric tons).⁴

While corn and other agricultural crops, such as sweet sorghum, sugar cane, sugar beet, etc, will remain a sizeable fraction of the starting material for liquid biofuels, other carbon sources will be required if renewable biofuels are to make more significant inroads into the world's energy portfolio. A variety of biomass materials are available for production of liquid biofuels, both intentionally grown for this purpose and that which is a side product or waste material from another process. The latter category includes agricultural residues, such as corn stover, fruit and vegetable processing wastes, plant trimmings; pulp and paper sludge; wood chips; cheese whey; and waste paper, to name just a few.^{5–18} The amount of this distributed biomass waste is significant, although often overlooked. For example, Kim and Dale estimated ethanol produced from the world's waste crops and crop residues could replace 32% of global gasoline consumption.¹⁴ Some of these waste materials, such as corn stover, are co-located with current large-scale ethanol production facilities. Many more sources of lignocellulosic material will be distributed in nature. The transportation costs associated with delivering material from smaller distributed sources to a large centralized biofuel plant can outweigh the low, no,

* Correspondence to: Leland M Vane, National Risk Management Research Laboratory, Office of Research and Development, US Environmental Protection Agency, Cincinnati, OH 45268, USA
E-mail: Vane.Leland@epa.gov

† This article is a US Government work and is in the public domain in the USA

(Received 22 September 2004; revised version received 1 December 2004; accepted 6 December 2004)

Published online 21 April 2005

or negative cost of the waste materials.¹⁹ Several articles provide overviews of the many technical and economic issues related to the production of ethanol from biomass.^{11–14,19–25}

A sample flow diagram for a biomass-to-ethanol process is provided in Fig 1. In this process, lignocellulosic biomass is converted into sugars which are then fermented to ethanol. Cellulose, hemicellulose, and lignin are the most prevalent components in lignocellulosic biomass. The most common sugars produced from these materials are glucose ($C_6H_{12}O_6$) and xylose ($C_5H_{10}O_5$) which can be converted fermentatively to ethanol, carbon dioxide, and a range of coproducts. Ideally, each unit mass of sugar yields about 0.5 unit mass of ethanol. Standard baker's yeast strains are capable of fermenting glucose, but not xylose. Other yeast strains, genetically engineered species, and other microorganisms can be employed to ferment xylose to ethanol.

One example of a distributed lignocellulosic biomass waste stream with the potential for conversion to ethanol is the sludge from pulp and paper mills. Several groups have studied the conversion of pulp and paper sludge to ethanol.^{3,5,17,26–28} According to a 1995 US Environmental Protection Agency (USEPA) report, the average pulp and paper mill produced 26 000 dry metric tons of sludge material per year—material which might typically be land-applied, converted to compost or animal bedding, or combusted for energy recovery as waste disposal practices.^{3,17,29} For virgin paper plants, this represents a mass of sludge equal to 5% of the mass of the final paper product. Plants which produce recycled paper generate twice as much sludge; the mass of sludge is therefore approximately 10% of the product paper mass. Each dry metric ton of sludge can produce up to 70 gallons (265 liters) of ethanol, thus the average paper mill could produce up to 1.8 MGY (6.8 MLY) of ethanol from this waste stream.²⁶ Although this volume is small compared to a 40 MGY (150 MLY) corn-to-ethanol plant, the 555 US pulp and paper mills could collectively account for 1 billion gallons per year (3.8 billion

liters per year) of ethanol—equivalent to one-third of the US ethanol production volume in 2003 [Source: BBI International]. The vision of efficient, small-scale, distributed production of biofuels is exemplified by a recent US Army research grant solicitation entitled 'Tactical Biorefinery for Forward Fuel Production' in which the Army envisions using waste material as a source of energy and biofuels to reduce the need for fuel resupply of forward units. Although the military has special needs and acceptance criteria, the 'tactical biorefinery' must still be energy efficient at the small scale. A process which meets the energy efficiency criterion of the US Army as well as the economic criteria of the private sector will be commercially viable. As stated in the commercialization vision from the 2004 US Army Small Business Technology Transfer (STTR) solicitation: 'A small biorefinery which can effectively reduce the cost of waste disposal and removal while simultaneously providing an offsetting fuel value would be an attractive end-item in a number of agricultural and manufacturing industries'.

What is needed is a process train which can convert lignocellulosic biomass materials to biofuels such as ethanol or butanol in an efficient, cost-effective manner at a small scale, most likely with a variable feed source composition. The stages of the biomass-to-biofuel process train must be reassessed individually and collectively in order to arrive at the most efficient small-scale system. For example, recovery of ethanol from the fermentation broth has long been ceded to distillation for corn-to-ethanol operations. The economies of scale and the extent of heat integration which are achieved at the large scale make distillation economically and energetically efficient. From an analysis of ethanol production from biomass, Lynd concluded that the energy usage and cost of distillation is not a primary constraint to the competitiveness of such a process.¹² However, the advantages of distillation over competing separations technologies for biofuel recovery fade as the scale of the operation is reduced, thereby opening the door for other technologies such as gas stripping,^{9,10,30–43} liquid–liquid

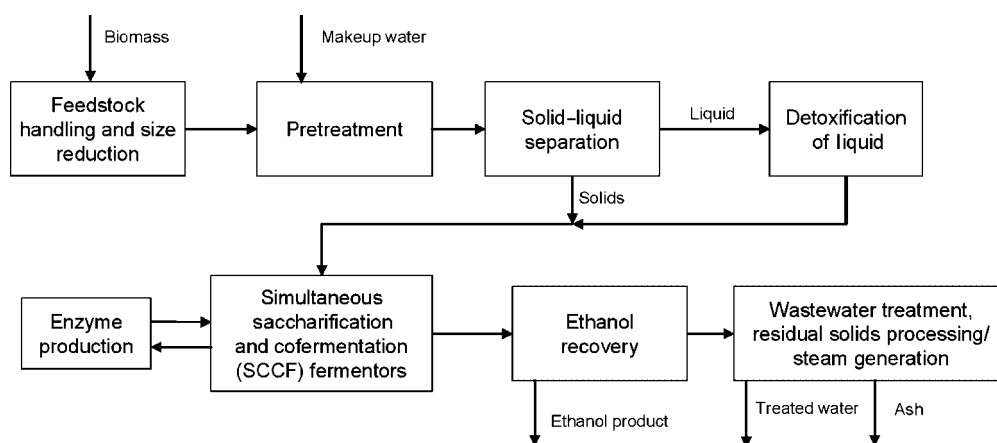

Figure 1. Simplified flow diagram for a biomass-to-ethanol process utilizing enzymatic hydrolysis and simultaneous saccharification and cofermentation.^{19,21}

extraction,^{34–39,44,45} vacuum stripping,^{35,36,38,46–51} membrane distillation,^{52,53} vacuum membrane distillation (VMD),^{31,34,54,55} sorption,^{34–38} and pervaporation.^{34–39,56–89} In this paper, the potential for using pervaporation in the recovery of liquid biofuels from dilute fermentation broths will be reviewed.

FUNDAMENTALS OF PERVAPORATION

Pervaporation is a process in which a liquid stream containing two or more miscible components is placed in contact with one side of a non-porous polymeric membrane or molecularly porous inorganic membrane (such as a zeolite membrane) while a vacuum or gas purge is applied to the other side. The components in the liquid stream sorb into/onto the membrane, permeate through the membrane, and evaporate into the vapor phase (hence the word ‘pervaporate’). The resulting vapor, referred to as ‘the permeate’, is then condensed. Due to different species in the feed mixture having different affinities for the membrane and different diffusion rates through the membrane, even a component at low concentration in the feed can be highly enriched in the permeate. Thus, the permeate composition may widely differ from that of the vapor evolved after a free vapor–liquid equilibrium process. Enrichment factors, the ratio of the permeate to feed concentrations of a compound, range from the single digits to over 1000, depending on the compounds, the membrane, and process conditions. A schematic diagram of the pervaporation process is shown in Fig 2. As depicted in Fig 2, by separating the extracting vapor phase from the feed liquid with a membrane which is selective for Species 1, the permeate vapor is enriched in Species 1 relative to the feed liquid. The main process units of a pervaporation process: feed source, feed pump, heater, membrane module, condenser, and vacuum pump, are pictorially shown in Fig 3.

The properties of the membrane material dictate the separation achieved in the process. For example, if the membrane is hydrophobic, then the membrane will preferentially permeate organic compounds relative to water and the permeate will be enriched in the

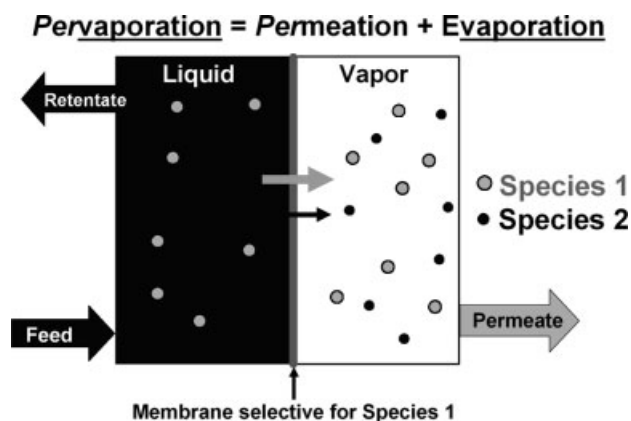

Figure 2. Schematic diagram of pervaporation process.

organic compounds. Alternatively, if the membrane is hydrophilic, then water will be enriched in the permeate and the organic compound in the feed liquid will be dehydrated. The general process components are the same, only the membrane material has been changed. The dehydration of organic solvents, particularly those which form azeotropes with water (such as ethanol and isopropanol) is the main commercial use of pervaporation today.⁹⁰ In the dehydration application, pervaporation competes with molecular sieve sorption and ternary or vacuum distillation. For the production of biofuels, pervaporation can therefore be applied to both the recovery of alcohols from water and for the dehydration of the alcohols to meet fuel dryness specifications. According to ASTM standard D4806, the maximum amount of water allowed in fuel ethanol is 1 vol% (0.8 wt%).^{91,92}

The driving force for transport across the membrane in pervaporation is the chemical activity difference of a species between the bulk feed liquid and the bulk permeate vapor. Flux through the membrane is inversely proportional to the overall resistance and proportional to the concentration gradient (as a representation of the activity difference) between the bulk liquid and the bulk permeate vapor as follows:

$$\mathcal{J}_i = k_i [C_i^L - C_i^V] = k_i C_T \left[x_i - \frac{P_i^V}{\gamma_i P_i^{\text{sat}}} \right] \quad (1)$$

where \mathcal{J}_i is the flux of species i ($\text{mol m}^{-2} \text{s}^{-1}$), k_i the overall mass transfer coefficient (m s^{-1}) which is the inverse of the overall mass transfer resistance, C_i^L the bulk feed liquid concentration of species i (mol m^{-3}), C_i^V the liquid phase concentration (mol m^{-3}) of species i which would be in equilibrium with a permeate vapor containing species i at a bulk partial pressure of P_i^V (Pa), x_i the mole fraction of i in the feed liquid, C_T the total molar density of the feed liquid (mol m^{-3}), γ_i the activity coefficient of i in the feed liquid, and P_i^{sat} the saturated vapor pressure of component i .

The resistance to transport between the bulk feed liquid and the bulk permeate vapor consists of diffusion in the stagnant or near stagnant liquid layer next to the feed/upstream side of the membrane, transport through the membrane, and diffusion in the vapor layer on the permeate/downstream face of the membrane. The latter is considered small compared to the first two so that the liquid boundary layer and membrane represent the most significant barriers to transport. The overall mass transfer coefficient, k_i , is estimated as:

$$\frac{1}{k_i} = \frac{1}{k_i^L} + \frac{1}{k_i^{\text{mem}}} + \frac{1}{k_i^V} \quad (2)$$

$$\text{where } k_i^{\text{mem}} = \frac{\gamma_i P_i^{\text{sat}} P_i^{\text{mem}}}{TC_T} \quad (3)$$

where k_i^L , k_i^{mem} , and k_i^V are the liquid boundary layer, membrane, and vapor boundary layer mass transfer coefficients, respectively, and P_i^{mem} the

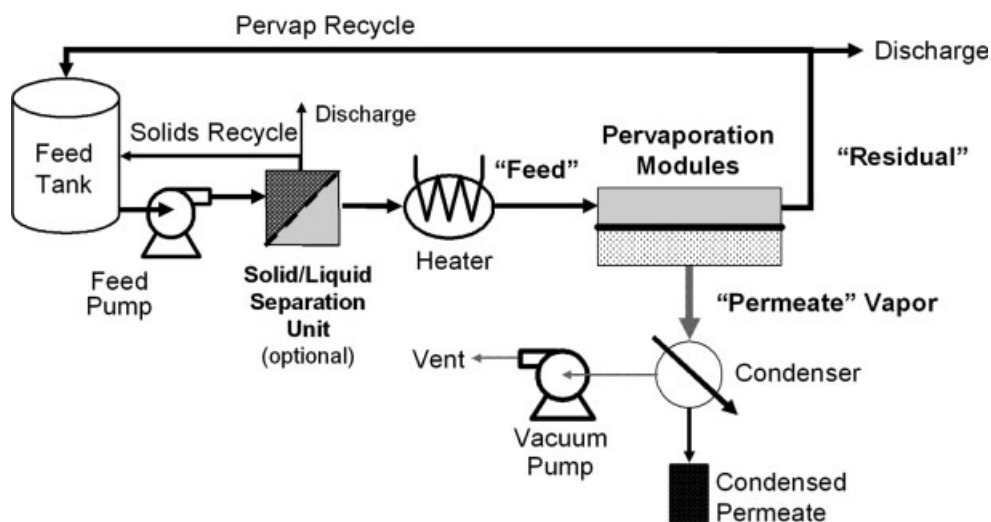

Figure 3. Flow diagram for generic pervaporation system.

membrane permeability coefficient (mol (m Pa s)^{-1}) (all for species i). Additionally, T is the membrane thickness (m).

A steady state mass balance on species i over a differential area (or length) of membrane module can be written by relating the change in concentration of species i in the feed liquid to the flux of i through the membrane as follows:

$$Q \, dC_i = \mathcal{J}_i \, dA \quad (4)$$

where Q is the liquid flow rate ($\text{m}^3 \text{s}^{-1}$) and dA is the differential membrane surface area for the module element. By integrating eqn (4) over the length of a membrane module (over area A) using eqn (1) to represent \mathcal{J}_i , the effect of membrane area A (m^2) on the concentration of species i in the residual stream (C_i^R) from a pervaporation module at feed liquid flow rate Q can be estimated from the feed concentration (C_i^F) as follows:

$$\ln \left(\frac{C_i^R - C_i^V}{C_i^F - C_i^V} \right) = \frac{-k_i A}{Q} \quad (5)$$

where the permeate composition (C_i^V) and the mass transfer coefficient (k_i) have been assumed to be constant throughout the module.

In addition to flux, the performance of a pervaporation membrane is judged by the degree to which it is able to separate one compound from another and deliver a permeate highly enriched in one of the compounds. A full representation of the separation capability of the membrane would be a plot of the permeate composition vs feed composition—much the same way as vapor–liquid equilibria are represented. In most cases, the quality of the separation is reported as the ‘separation factor’ of Species 1 relative to Species 2 (α_{12}) and is defined as the ratio of the

ratio of permeate compositions to the ratio of the feed compositions as follows:

$$\alpha_{12} = \frac{(C_1^V/C_2^V)}{(C_1^L/C_2^L)} = \frac{(\mathcal{J}_1/\mathcal{J}_2)}{(C_1^L/C_2^L)} \quad (6)$$

According to this equation, a membrane with a separation factor of 1 yields a permeate with the same composition as the feed. A membrane with a separation factor which approaches infinity would permeate only Species 1 and would be the ideal membrane if the objective is to selectively remove Species 1 from the feed liquid. The truly ideal pervaporation membrane would exhibit both a high flux and a high separation factor. In reality, even this ‘ideal’ membrane is not appropriate for all scenarios (for example, if the permeate partial pressure of the preferential permeating species limits transport). Thus, the properties of the membrane must be matched to the desired separation performance and the physical limitations of the process.

As outlined above, the relative separation delivered by a pervaporation system is primarily a function of the membrane material and the feed species. Feed temperature, feed composition, and permeate pressure have secondary effects. Flux is a function of these same variables. In fact, flux is a rather strong function of all of these variables. Unlike separation factor, flux is a strong function of the thickness of the membrane, often a linear function of the reciprocal of membrane thickness.

Molecules which end up in the permeate experience a phase change from liquid to vapor which requires energy to fuel the evaporation. Therefore, one result of pervaporation is a cooling of the feed liquid as it traverses the membrane module. Fortunately, only the fraction of material which permeates the membrane is evaporated. In the case of an infinite separation factor ($\alpha \rightarrow \infty$), heating and cooling would only be used to evaporate and condense the desired permeate product species. Since α is never infinite, heat must be applied

to evaporate not only the desired permeate species, but the undesired permeating species as well. In the case of removing ethanol from water, the energy cost of delivering a unit of ethanol as condensed permeate is the sum of the energy required to evaporate and condense both the desired ethanol and the undesired water in the permeate. On a molar basis, water and ethanol have similar heats of evaporation (40.7 vs 38.6 kJ mol⁻¹). However, due to the difference in molecular weights, the heat of evaporation on a mass basis is significantly higher for water than for ethanol (2260 vs 838 kJ kg⁻¹). Thus, if the permeate contains 50 wt% ethanol, 1 kg of water is evaporated and condensed per 1 kg of ethanol with 73% of the energy involved required for the water component. Therefore, in order to achieve highly energy efficient recovery of alcohols from water, high alcohol–water separation factors are desired.

If the temperature change of the feed liquid is excessive due to evaporation, then interstage heating may be required to maintain the desired liquid temperature. If batch or semi-batch operation is feasible, then an alternative to interstage heating is to increase the recirculation flow rate through the membrane modules. The effect of increased flow rate is a decrease in the single-pass temperature drop so that the per-stage temperature drop is decreased. The higher flow rate will also result in a lower per pass alcohol removal.

According to eqn (1), the maximum driving force (and therefore maximum flux through the membrane) is achieved at the maximum feed concentration, the minimum permeate partial pressure of a given species, and the maximum feed liquid temperature. Obviously, there are limits to each of these. For example, the feed concentration is dictated by the upstream process and is generally not independently controlled. The permeate partial pressure is theoretically limited to absolute 0 pressure, but practically limited by the capital and operating costs associated with producing a given vacuum level. Total permeate pressures of less than 10 torr (1.3 kPa) are typically uneconomical when using mechanical vacuum pumps—pressures in the range of 30 to 100 torr (4 to 13 kPa) are more preferred. Feed temperature is limited first by the

boiling point of the feed mixture and secondarily by the temperature sensitivity of components of the feed. Feed pressurization can be used to increase the boiling point of the feed liquid thereby expanding the available temperature range.

The tradeoffs associated with a maximal operating temperature are highlighted in Table 1. Unless limited by the presence of temperature sensitive feed liquid components, the advantages of operating at a high temperature typically outweigh the disadvantages—primarily due to the reduced membrane area required to achieve a desired separation due to the higher flux. Based on our observations with silicone rubber membranes, the amount of membrane area required to remove a given amount of ethanol from water is on the order of ten times higher at 30 °C than at 80 °C. Potential temperature-sensitive components can be either biotic in nature, such as proteins, enzymes or living microorganisms, or abiotic, such as certain aroma/flavor compounds. Raw fermentation broths originating from biomass-to-ethanol processes will contain a variety of temperature-sensitive biotic components including live yeast or bacteria. Several flowsheet scenarios are available for processing such streams with pervaporation as has been well outlined by Groot *et al*^{75,81} and Mulder and Smolders.⁶⁹

INTEGRATION OF PERVAPORATION WITH FERMENTATION SYSTEMS

A comparison of different authors' research on alcohol fermentations is difficult due to the number of variables that enter into the reported results such as: type, strain, growth phase and loading of microorganism; source, pretreatment, and concentrations of nutrients and substrate; temperature and temperature history; pH and pH history; oxygen concentration; fermentor design, and level of mixing. Adding the variables associated with separation technologies to the fermentation variables yields an even more complex system from which few direct comparisons are possible. However, a number of general trends and observations can be made from this body of research:

- (1) *Fermentor productivity will increase upon application of a solvent removal technology if the*

Table 1. Advantages and disadvantages of operating pervaporation at the maximum possible temperature

Advantages	Disadvantages
<ul style="list-style-type: none"> • Highest flux • Highest allowable permeate pressure (reduced vacuum requirement) • Lowest permeate condensation costs (ability to operate at higher coolant temperatures) • Yields system with the lowest required membrane area 	<ul style="list-style-type: none"> • Harmful to temperature-sensitive compounds and microorganisms • Higher likelihood of precipitate formation • Increased heater capital costs • Requires high temperature heat source • Requires heat exchanger to recover heat from residual stream • Material failure more likely • Increased material property requirements • Requires more insulation • Reduced separation factor (permeate concentration)—dependent on compound and membrane properties

microorganisms exhibit inhibition by the solvent product at concentrations readily achieved in the fermentor.^{9,10,20,61,75,76,93–95} Microorganisms, including standard yeast strains, usually experience strong ethanol inhibition above 5–8 wt% ethanol while strong butanol inhibition occurs above 1 wt% *n*-butanol.³⁸ Thus, butanol productivity will be enhanced relatively more than ethanol productivity if a solvent-removal technology is coupled with the fermentor. Solvent inhibition varies a great deal among microorganisms though. For example, *Pichia stipitis* CBS 5773 experiences ethanol inhibition at 2 wt% ethanol, which is several times lower than the concentration of ethanol found to inhibit *Saccharomyces cerevisiae*.⁴² As a result, organisms which are highly sensitive to the produced solvent but which otherwise possess superior performance characteristics (for example, thermotolerance) could be employed if the solvent concentration is depressed using a separation technology.

- (2) *Increasing the concentration of viable cells in the fermentor will increase the solvent productivity of the fermentor, all other variables being equal.*^{41,56,71,74,75,79,89,96} For example, Nakao *et al* observed a 200–300% increase in fermentor ethanol productivity (mass of ethanol produced per unit of reactor volume per unit of time, ie $\text{kg m}^{-3} \text{h}^{-1}$) when pervaporation was coupled directly with a fermentor.⁷⁹ This productivity increase was primarily due to an increase in the concentration of viable yeast cells through either cell immobilization or water removal via pervaporation with a smaller effect of reduced ethanol inhibition—the productivity per viable cell only increasing 20–50% due to inhibition reduction. Increases in the concentration of viable cells in the fermentor can be achieved with a cell separation technology and cell recycle, as will be discussed in the next section, or by immobilizing the cells.^{54,72,75,79,97–104} Increased biomass concentrations are particularly attractive when consumption of a particular substrate is slow. For example, consumption of xylose by *Saccharomyces cerevisiae* is slower than consumption of glucose, so xylose consumption per unit volume of reactor can be improved by increasing the yeast concentration.⁹⁶ Since pervaporation removes water along with produced ethanol, cell density will increase upon application of pervaporation, although this increase will be small compared to that achieved using other approaches like filtration.⁷⁵ Unfortunately, few studies in which product separation technologies have been mated to fermentors actually monitored the concentration of viable cells; without this information the true increase in productivity cannot be assessed.
- (3) *Integrating a solvent recovery unit with a fermentor enables the use of more concentrated substrate*

solutions which increases the productivity of the fermentor and reduces the amount of water processed in the system.^{20,24,33,43,54,56,61,93,105} Taylor *et al* were able to feed a 550 g dm^{-3} glucose solution to a fermentor while maintaining the ethanol concentration in the fermentor at about 5 wt% by removing the ethanol via a gas stripping process.³³ Otherwise, this concentration of glucose would generate inhibitory concentrations of ethanol. Unfortunately, each of the first three trends may also lead to undesirable consequences such as higher levels of non-alcohol inhibitors.^{38,56,66,71,86,89} These inhibitors may include organic acids (such as formic, acetic, citric, butyric, and lactic acids), organic compounds (such as acetaldehyde, ethyl acetate, methanol, isobutanol, methyl butanol, furfural, 5-hydroxymethylfurfural), and salts (such as NaCl, MgCl_2).^{10,20,56,71,76,86} By increasing fermentor productivity, higher amounts of substrate are fed/consumed per unit volume of the fermentor. Thus, regardless of whether the inhibitors are produced by the microorganisms or are present in the substrate solution (possibly from the biomass pretreatment regimen), their concentration can be expected to be higher when fermentor productivity is increased when utilizing higher substrate concentrations or by recycling cells and/or broth. For separation technologies, like pervaporation, gas stripping, and even distillation, which remove only materials which can be volatilized from the broth, compounds which are non-volatile or exhibit a low tendency to volatilize from the broth will accumulate in the fermentor if the stripped broth is recycled to the fermentor. As a result, attention should be paid to the presence of these inhibitors with mitigation controls established if they are deemed to significantly impact system productivity.

- (4) *A variety of separation technologies, including pervaporation, are technically viable to recover biofuels from fermentation broths.* A list of potential separation technologies and references describing those technologies was provided in the introduction section. Each of the possible separation technologies has advantages and disadvantages and several articles provide overviews as to how they relate to the recovery of fermentation broth components.^{34–39} In addition, these separation technologies are generally applicable to a wide array of fermentative organisms. For example, pervaporation has been coupled with fermentations involving one or more strains of *Saccharomyces cerevisiae*, *Zymomonas mobilis*, *Clostridium thermohydrosulfuricum*, *Escherichia coli*, *Candida pseudotropicalis*, *Clostridium beijerinckii*, and *Clostridium acetobutylicum*.

Solid-liquid separation

As noted previously, the most cost-effective pervaporation system is most likely one which is operated at the maximum possible feed temperature. Therefore, if temperature-sensitive materials are present in the feed material, then the pervaporation system will either have to be operated at a temperature lower than the operational optimum, the sensitive materials will need to be removed prior to being exposed to harsh pervaporation conditions, or a certain incapacitation of the sensitive materials will need to be accepted. Removal of the sensitive particulate materials can be achieved with either a filtration device or a centrifugation unit. In most biofuel fermentation scenarios, the temperature-sensitive materials are microorganisms. As a result, microfiltration (MF) and centrifugation are both viable separation options as the solids separation unit shown in Fig 3.^{106–108} As a barrier-based technology, membrane filtration has the advantage that it will, theoretically, remove all solids above the design range of the filter. In fact, drinking water providers have begun considering membrane filtration for the removal of harmful pathogens from tap water.^{109–113} MF is capable of removing most fermentative microorganisms. If proteins or enzymes must be retained as well, then ultrafiltration (UF) or nanofiltration (NF) may be required. For example, Knutsen and Davis have reported the use of sedimentation and UF to recover and reuse cellulase enzymes.¹¹⁴ Centrifugation is commonly used for solid-liquid separations in the corn-to-ethanol industry. However, in that industry, the ethanol recovery technology, distillation, can be designed to handle solids and there may not be a need to protect the distillation system from solids in the feed stream unless it leads to a more economical design or if solids recycle is desired. Thus, centrifuges are used to recover saleable distillers dry grains (DDGs) from the still bottoms which have already been exposed to the high temperatures of the distillation column (*c* 100 °C).^{115,116} Centrifuges may also be used to separate components in the ground and swollen corn.

Membrane filtration is now a standard unit operation in the food/beverage and pharmaceutical production industries for separating solids and dissolved solids from process streams.^{117,118} Membrane filtration has the advantage that solids larger in size than the size cutoff range of the membrane are rejected by the membrane. In centrifugation, no absolute or relative cutoff standard exists. In addition, centrifugation is only able to separate materials based on density differences. Thus, fermentor solids with a density similar to that of the broth will be difficult to remove by centrifugation. However, centrifugation should be able to produce significant reductions in solids from fermentation broth because the high *G*-forces generated in the centrifuge make up for the low density difference. Membrane separation performance, on the other hand, is not a function of the density of the solids

to be removed. For example, researchers at Lund University recently reported results comparing the solids separation performance of a vibrating MF membrane unit to that of a decanter centrifuge.¹¹⁹ The feed to the separation processes was a simultaneous saccharification and fermentation (SSF) broth containing 3% dry matter. Both the centrifuge and the MF unit delivered slurries containing about 18% solids. However, while the MF permeate was free of particles, the centrifuge only achieved solids recoveries of 60–80%, even at low feed flow rates, indicating that the centrate contained significant amounts of solids. Maybury *et al* observed a maximum clarification efficiency of *c* 70% for a continuous centrifuge using yeast cell debris while efficiencies up to 99.3% were possible when removing polyvinyl acetate particles.¹²⁰ Hansen compared a filter press, centrifuge, cross-flow ceramic MF unit, and a vibrating MF unit for yeast extract recovery from beer fermentors.¹⁰⁶ The low capital cost of the centrifuge was offset by high energy consumption and poor centrate quality (high haze) relative to the MF units. The filter press, too, was cited for poor filtrate quality due to haze, although the filter press delivered a cake containing 35% dry matter (vs 17% dry matter for the centrifuge). Both MF units delivered 18% dry matter retentate with clear permeates. Hydrocyclones were observed to yield yeast cell recoveries similar to that of continuous centrifuges (ie in the 70–90% range).¹²¹

The main vulnerability of membrane filtration is potential fouling of the membrane surface or of the internal pores. One culprit in the fouling of some membrane modules is the flow spacer used to separate membrane sheets. Particulate material can become trapped in the spacer, thereby blocking the flow path, creating dead zones, blocking the surface of the membrane, and increasing pressure drop. Membrane fouling has been addressed through module design (rotating disk filters, vibrating modules, tubular membranes, ceramic membranes, open flow channels, turbulence enhancing inserts) and operating procedures (high cross-flow feed liquid velocity, air sparging, backflushing, cleaning regimens).^{122–140} In the case of the vibrating module, lateral oscillations of the membrane surface (2.5 cm amplitude at ~60 Hz) create high surface shear rates which disrupt the formation of a surface foulant layer. Postlethwaite *et al* demonstrated the ability of a vibrating MF system to generate a permeate flux at high yeast solids concentrations (200–500 g dm⁻³ wet weight) which was the same as a standard MF system operating at a much lower yeast concentration (6 g dm⁻³ wet wt).¹³⁰ The capital costs of vibrating membrane systems are typically higher, per unit area, than conventional cross-flow membrane systems, although they may be comparable on a per unit flux basis since they will deliver a higher flux per unit area. The vibrating design is energy efficient and has been observed to consume less energy than a cross-flow filtration system.^{106,141} Our own observations (unpublished) and those of

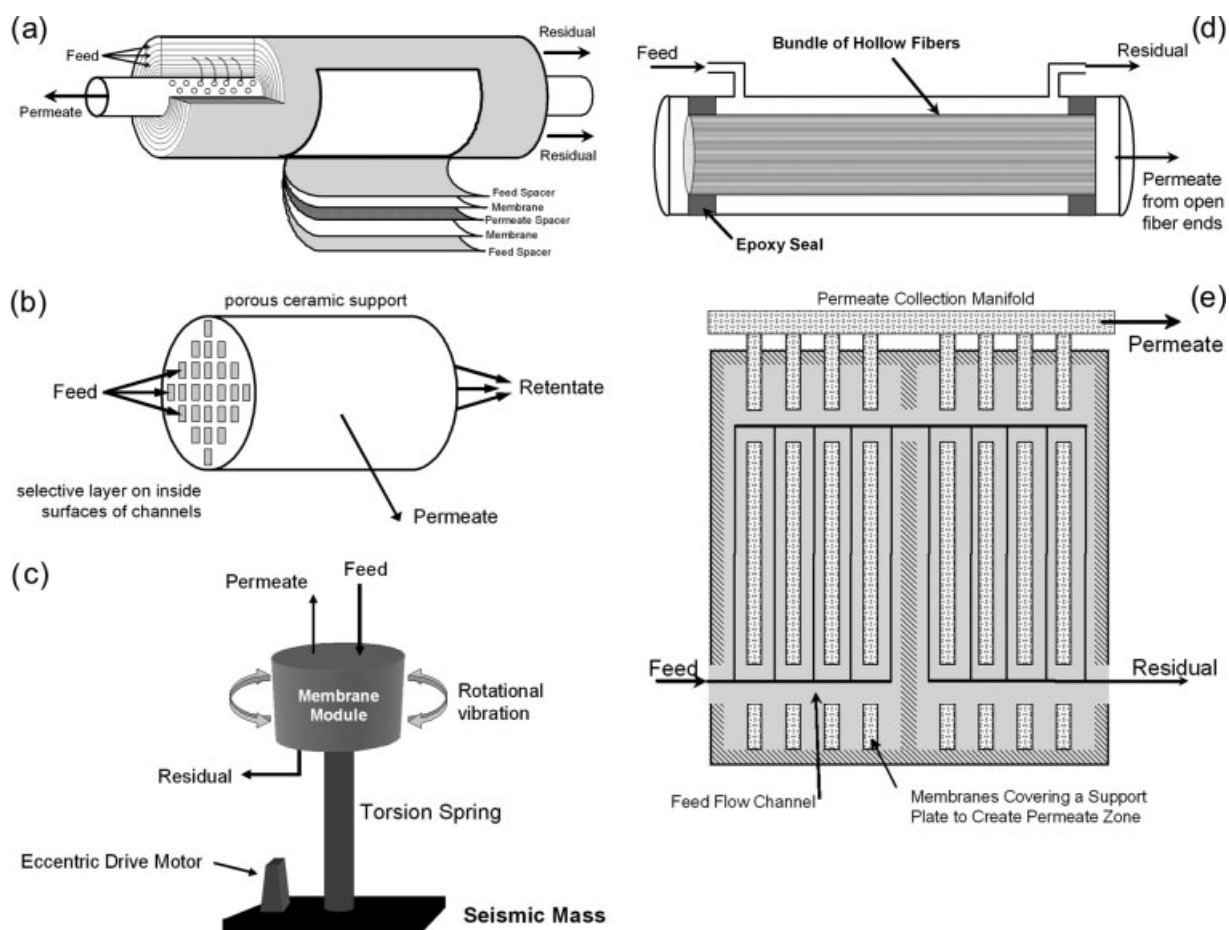

Figure 4. Illustrations of various membrane module configurations: (a) spiral wound, (b) monolithic ceramic, (c) vibrating disk stack, (d) hollow fiber, and (e) plate and frame.

others working with high shear membrane systems suggest no damage to the microorganisms due to the membrane processing.¹²⁵ Diagrams of several membrane module configurations are provided in Fig 4.

The presence of a solid–liquid separation device before the pervaporation system not only removes temperature-sensitive broth components, thereby allowing pervaporation operation at elevated temperatures, it also protects the pervaporation modules from fouling by solids in the broth. This is not to say that all pervaporation modules are sensitive to fouling by solids. Many of the same fouling-resistant module designs which have been developed for filtration are also available or possible for pervaporation. In order to avoid fouling of the liquid flow path, these modules either do not have a flow spacer or a flow spacer with a low solids accumulation capability has been selected. Spacer-free pervaporation modules include plate-and-frame modules (without flow spacers),^{99,142–144} vibrating modules,^{145–148} tubular membranes,^{72,77,149–152} and monolithic modules with open flow channels.^{153,154} Spiral wound modules must, by their design, contain a spacer to create a channel for the feed liquid to traverse the module. However, the flow spacer can be designed to discourage the accumulation of solids. Recently, ROChem

introduced a spacer-free spiral wound filtration module referred to as the ‘ST’ spacer tube design.¹⁵⁵ Spiral wound modules are second only to hollow fiber modules in terms of the membrane area which can be housed in a given volume of module. Hollow fiber membrane modules, too, can be designed to avoid solids accumulation although solids flow through the lumen (inside) of the fibers is inherently limited by the inner diameter of the fibers. As a result, use of hollow fiber modules with solids-laden liquids will be most likely limited to shell-side fed modules. Currently, only spiral wound modules are commercially available for the recovery of alcohols from water.

Based on the above discussion, a pre-pervaporation solid–liquid separation device, although not required, would reduce the fouling potential of solids in the fermentor broth and enable the use of the full range of pervaporation module options. The recovered biosolids could also be returned to the fermentor to increase the productivity of the fermentor by increasing the concentration of viable cells in the reactor. From a pervaporation standpoint, the simplest situation would be one in which the pervaporation modules are able to accept the fermentation broth as delivered from the fermentor (including solids) and the broth contains no temperature-sensitive components (or the sensitive components are no longer necessary in the

process)—all at a minimum cost. The addition of any separation device to the system adds capital and operating costs. Thus, an economic tradeoff exists between the increased efficiency of pervaporation (by enabling higher temperature operation and the ability to use the most efficient module design) combined with the increased fermentor productivity vs the increased complexity of adding a pre-pervaporation separation device.

Thermophilic and thermotolerant fermentative microorganisms

An alternative to introducing a solid–liquid separation device for the protection of temperature-sensitive microorganisms is the use of thermotolerant or thermophilic fermentative organisms. If thermotolerant organisms are used, then they could be exposed to elevated temperatures in a pervaporation system and still be recycled to the fermentor with a small or no loss in viability. For example, Moniruzzaman *et al* report that a temperature excursion to 50 °C lasting 2 h did not alter the ultimate batch ethanol yield of the KO11 *E coli* strain although the time to reach the ultimate yield was longer than in the 35 °C control.¹⁵⁶ Even standard yeast can survive at elevated temperatures for short periods of time, especially during the stationary phase of cell lifecycle and this thermotolerance can be induced in the organisms.^{157–161} The important point here is that the organisms only have to tolerate the elevated temperatures for a time equal to the liquid residence time in the pervaporation system. Unfortunately, even thermotolerant microorganisms cannot survive when exposed to temperatures above their tolerance range. The most likely maximum temperature for standard *S cerevisiae* is 50 °C. For truly thermophilic organisms, the temperature of the fermentor would be elevated and might even be the same as that of the pervaporation system. For example, Mori and Inaba investigated ethanol production from starch by the anaerobic thermophile *C thermohydrosulfuricum* YM3 and coupled the fermentor with a pervaporation module.⁷¹ Both the fermentor and the pervaporation unit were operated at 66 °C. Similarly, Agrol Limited markets a thermophilic bacteria for the production of ethanol.¹⁶² Since the saccharification activity of most enzymes used in biofuel production processes is optimum at elevated temperatures, the higher temperatures afforded by thermotolerant and thermophilic organisms would reduce the enzyme demand of the process. For example, the optimum temperature range for cellulase activity is 45–50 °C.^{24,163} Operation of the fermentation at elevated temperatures has the added advantage of limiting contamination by undesirable microorganisms.

Membrane materials for alcohol recovery by pervaporation

Many membrane materials have been studied for the purpose of recovering organic compounds from water

by pervaporation. Only those materials with leading properties will be mentioned here.

The current benchmark hydrophobic pervaporation membrane material is poly(dimethyl siloxane) [PDMS], often referred to as ‘silicone rubber’. PDMS is an elastomeric material which can be used to fabricate hollow fiber, tubular, unsupported sheet, or thin layer supported sheet membranes. Several companies have manufactured thin PDMS supported membranes over the years. At present, Membrane Technology and Research, Inc (MTR) of Menlo Park, CA is the leading supplier, manufacturing spiral wound modules out of their supported silicone rubber membranes. A list of alcohol–water separation data from the literature for PDMS membranes is assembled in Table 2. As seen from the third column, the reported ethanol–water separation factor for ‘pure’ PDMS membranes ranged from 4.4 to 10.8. The broad range in ethanol–water separation factors for PDMS membranes is typical of performance parameters reported in the literature for a given polymer and separation situation. The breadth in values arises from a variety of factors, including the source of the polymer starting materials (although called ‘PDMS’, there are often differences), the method of casting the film, the cross-link density, the thickness of the selective layer, the porous support material (if any), and the test conditions. Reported butanol–water separation factors for PDMS also cover a fairly broad range, from 40 to 60, which is 6–10 times that of ethanol–water.

Much effort has been expended searching for polymeric materials with better ethanol–water separation performance than PDMS. Unfortunately, seldom have materials been reported to improve upon PDMS. A few references observed values above the PDMS range for membranes based on PDMS, including PDMS impregnated in a porous PTFE support ($\alpha = 14.0$);⁷¹ silicone oil supported in a porous polypropylene (PP) support (α up to 12.6);¹⁶⁴ and a PDMS film treated with octadecyldiethoxymethylsilane ($\alpha = 16.3$).¹⁶⁴ Literature data for the latter of these are included in Table 3. Another material which has received significant attention is poly[1-(trimethylsilyl)-1-propyne] or ‘PTMSP’—a high free volume polymer displaying a permeability greater than that of PDMS.^{80,165–169} As shown in Table 3, the ethanol–water separation factor for PTMSP has been reported to be higher than that of PDMS, ranging from 9 to 26. The butanol–water separation factor for PTMSP has been observed to be as high as 70.¹⁷⁰ Unfortunately, PTMSP membranes have, so far, proven to deliver unstable performance, with flux and selectivity declining with time. Such changes have been attributed to the compaction of the polymer film or the sorption of foulants inside the film.⁸⁵ Recently, PTMSP has been cross-linked to yield a more physically stable material which may improve prospects for this polymer.^{171,172} Table 3 also contains ethanol–water separation performance data reported in the literature for polymeric materials other than

Table 2. Alcohol–water separation factors of PDMS membranes

Alcohol	Temp (°C)	Alcohol–water α	Thickness (μm)	Notes (feed EtOH conc, source of PDMS, flux, vacuum)	Ref
Ethanol	66	14.0	5 ^a	1.5 wt% EtOH, porous PTFE impregnated with PDMS in pores, 10 torr vacuum	71
Ethanol	25	8.8–12.6	25 ^a	Supported liquid membrane, PDMS oil in porous support, viscosity of oil = 5–100 cSt, 4 wt% EtOH	164
Ethanol	30	10.8	100	8 wt% EtOH, cross-linked oligodimethylsiloxane with acetoxysilyl groups	210
Ethanol	66	10.4	120	1.5 wt% EtOH, 10 torr vacuum	71
Ethanol	20–90	9–10	25	5 wt% EtOH, $\alpha = 11$ at <1 wt% EtOH	211
Ethanol	35	9.0	200–400	6 wt% EtOH, <2 torr, $\alpha = 8.6$ and 8.7 at 50 and 65 °C, respectively, GE 615 PDMS	212
Ethanol	30	8	120	9 wt% EtOH, 6–7 torr vacuum, Fuji System PDMS membrane, same α observed for porous PTFE and PP	79
Ethanol	35	8	NA	2 wt% EtOH, fermentation broth, two experiments yielded $\alpha = 7.7$ and 8.2	86
Ethanol	40	8	160	16.5 wt% EtOH, PDMS from Tisso Co Ltd, observed effect of PDMS chain length on α	213
Ethanol	25	7.7	20 ^a	6 wt% EtOH, 1–3 torr vacuum, $\alpha = 6.7$ at 3 wt% EtOH, MTR PDMS membrane	80
Ethanol	22.5	7.6	NA	5 wt% EtOH, GE 615 PDMS	214
Ethanol	22–25	7.6	100	5.5 wt% EtOH	69
Ethanol	22	7.3	105	7 wt% EtOH	215
Ethanol	42	6.5	1 ^a	5 wt% EtOH	56
Ethanol	30	6	2.2 ^a	5 wt% EtOH, 5 torr vacuum, α rises to 8 at 20 torr vacuum	181
Ethanol	50	5.3	~120	4.4 wt% EtOH	216
Ethanol	35	~5	NA	6 wt% EtOH	217
Ethanol	35	5	NA ^a	6 wt% EtOH, GFT (now Sulzer) PDMS membrane (composite)	217
Ethanol	40	5	~225	0.01 wt% EtOH in presence of aroma compounds	218
Ethanol	22	4.4	3 ^a	7 wt% EtOH	215
<i>n</i> -Butanol	37	60	250	0.1 wt% <i>n</i> -BuOH, $\alpha \downarrow$ to 25 as conc \uparrow to 0.8 wt%, PDMS tubes, N ₂ sweep gas	99
<i>n</i> -Butanol	50	58	50	1 wt% <i>n</i> -BuOH	219
<i>n</i> -Butanol	62	50	75	2 wt% <i>n</i> -BuOH, $\alpha \uparrow$ with \uparrow temp, $\alpha = 40$ at 26 °C, MemPro MEM-100™ PDMS	68
<i>n</i> -Butanol	50	49.6	50	GE VTR615 silicone rubber, 10 g dm^{-3} <i>n</i> -BuOH	83
<i>n</i> -Butanol	41	42	600	0.25 wt% <i>n</i> -BuOH, $\alpha \downarrow$ to 27 as conc \uparrow to 3 wt% <i>n</i> -BuOH, PDMS tubes, air sweep gas	188
Methanol	22.5	7.6	NA	5 wt% MeOH, GE 615 PDMS	214
Methanol	30	6	8 ^a	~5 wt%, Sulzer PERVAP-1060 membrane	220
2-Propanol	22.5	9.5	NA	5 wt% <i>i</i> -PrOH, GE 615 PDMS	214
2-Propanol	22–25	9.5	100	5.5 wt% <i>i</i> -PrOH	69
<i>n</i> -Propanol	22–25	19.1	100	5.2 wt% <i>n</i> -PrOH	69
<i>n</i> -Propanol	60	14.8	20 ^a	5.2 wt% <i>n</i> -PrOH	207
<i>n</i> -Propanol	60	12.8	5.5 ^a	10 wt% <i>n</i> -PrOH, MTR silicone rubber membrane, 10 torr	207

^a Supported on porous material.

NA = data not available.

EtOH = ethanol, MeOH = methanol, *n*-PrOH = *n*-propanol, *i*-PrOH = 2-propanol, *n*-BuOH = *n*-butanol.

Note: 1 torr = 0.13 kPa.

PTMSP and PDMS with separation factors greater than that of benchmark PDMS. To the knowledge of this author, membranes constructed from these materials are not commercially available at this time.

While no organic membrane has yet to challenge PDMS as the benchmark hydrophobic pervaporation membrane material, inorganic membranes based on hydrophobic zeolites have shown both higher ethanol–water separation factors and ethanol fluxes than PDMS membranes. An extensive review of zeolite

materials and the fundamentals of using zeolites for pervaporation applications by Bowen *et al* was recently published.¹⁷³ Literature performance values for two types of hydrophobic zeolites, silicalite-1 and Ge-ZSM-5, are presented in Table 4. Silicalite-1, the most studied hydrophobic zeolite for this application, has been reported to deliver ethanol–water separation factors ranging from 12 to 72 with a typical value around 40—four to five times that of PDMS. The ethanol–water separation factor for pure silicalite-1

Table 3. Ethanol–water separation factors of other polymeric membranes

Polymer	Temp (°C)	Ethanol–water α	Notes (conc, flux, vacuum, thickness)	Ref
PTMSP				
PTMSP	30	15.1–19.9	6 wt% EtOH, 14–43 μm thick	169
PTMSP	30	15.1–19.3	6 wt% EtOH, 10–20 μm thick	167
PTMSP	30	19.9	6 wt% EtOH feed, α \downarrow with time and with exposure to fermentation broth	85
PTMSP	50	10.3	6–7 wt% EtOH feed	221
PTMSP	30	9	5 wt% EtOH, α \uparrow to 17 at 1 wt% EtOH	222
PTMSP	75	10.7	10 wt% EtOH, α \downarrow from 10.7 to 8 over 450 h	223
PTMSP	30	11.2	7 wt% EtOH	224
PTMSP	25	22.9	6 wt% EtOH, α lower for fermentation broth	80
PTMSP	66	18.7	1.5 wt% EtOH, 10 torr vacuum	71
PTMSP	60	10–26	6 wt% EtOH, 30 μm thick, 50 torr permeate pressure, α \downarrow from 26 to 10 over 150 h, soaking in ethanol recovered α	207
Modified PTMSP and other high free volume propynes				
PTMSP/PDMS graft copolymer	30	28.3	Max α at 12 mol% PDMS, 7 wt% EtOH	224
Phenyl propyne/PDMS graft copolymer	30	22.5	Poly(1-phenyl-1-propyne)/PDMS copolymer (75 mol% PDMS), 7.3 wt% EtOH, max α of ~ 30 at 50 °C	225
Trimethylsilyl substituted PTMSP	50	17.6	6–7 wt% EtOH feed, 10 mol% substitution of trimethylsilyl groups	221
<i>n</i> -Decane substituted PTMSP	50	17.8	6–7 wt% EtOH feed, 5 mol% substitution of <i>n</i> -decane groups	221
Poly(methyl phenyl siloxane)	50	11.7	4.1 wt% EtOH	216
Other polymers				
Styrene–fluoroalkyl acrylate graft copolymer	30	16.3–45.9	8 wt% EtOH, 20 μm selective layer on 100 μm PDMS layer, max α for heptadecafluorodecyl acrylate	210,226
Copolymer of polysiloxane and phosphate ester	25	5–31	5 wt% EtOH, range of α observed for 1–4 layers/coatings	227
IPAA/FA–PDMS blend	24	19.7	α drops to 14 as temp \uparrow to 50 °C, 2.5 wt% EtOH	228
Plasma polymerized silane	25	18.0	4 wt% EtOH, polymer of hexamethyltrisiloxane treated with octadecyldiethoxymethylsilane	164
Plasma polymerized silanes	25	13.2–16.9	4 wt% EtOH, max α for polymers of methyltrioctylsilane and octadecyldiethoxymethylsilane	164
PDMS plasma treated with octadecyldiethoxymethylsilane	25	16.3	4 wt% EtOH, 20 μm film	164
Polyhydromethylsiloxane–PDMS copolymer	25	14.4	Supported liquid membrane with polyhydromethylsiloxane–PDMS copolymer oil, 4 wt% EtOH in feed	164
Polysiloxaneimide ODMS/PMDA/MDMS	40	10.6	10 wt% EtOH, 1.5:2:0.5 equivalents of ODMS:PMDA:MDMS	229
Poly(methyl ethoxy siloxane)	50	10.5	4.4 wt% EtOH	216
Polyurethaneurea containing PDMS	40	8.6	10 wt% EtOH, 82 μm film	213
Plasma polymerized perfluoropropane	40	7.0	4.8 wt% EtOH, porous polysulfone support	230

PTMSP = poly[1-(trimethylsilyl)-1-propyne].

IPAA/FA = copoly(*N*-isopropylacrylamide/1H,1H,2H,2H-perfluorododecyl acrylate).

ODMS = α , ω -(bisaminopropyl) dimethylsiloxane oligomer.

PMDA = 1,2,4,5-benzenetetracarboxylic dianhydride.

MDMS = 1,3-bis(3-aminopropyl) tetramethyldisiloxane.

Table 4. Alcohol–water separation factors of hydrophobic zeolite membranes

Zeolite	Alcohol	Temp (°C)	Alcohol-water α	Notes (conc, flux, vacuum, thickness)	Ref
Silicalite-1	Ethanol	60	Up to 106	5 wt% EtOH, synthesis and pervaporation conditions varied, max performance with mullite porous support	231
Silicalite-1	Ethanol	60	30–89	Same as above, except max performance with alumina support	232
Silicalite-1	Ethanol	60	56–72	10 wt% EtOH, mullite tubular support	233
Silicalite-1	Ethanol	30	31–71	10 wt% EtOH, SS support, flux \downarrow when exposed to fermentation broth	84
Silicalite-1	Ethanol	30–60	60	4 wt% EtOH, SS support (lower α for alumina support), α independent of temperature	234
Silicalite-1	Ethanol	30	59	4 wt% EtOH, SS support (lower α for alumina support)	186
Silicalite-1	Ethanol	30	26–51	4 wt% EtOH, SS support, six samples	176
Silicalite-1	Ethanol	30	13–42	4 wt% EtOH, range from four membranes, SS support	60
Silicalite-1	Ethanol	30	41	5 wt% EtOH, α \uparrow to 88 with fermentation broth but flux \downarrow over 20 h, SS support	87
Silicalite-1	Ethanol	30	Ave = 28	4 wt% EtOH, SS support, α of four different membranes ranged from 13 to 42	60
Silicalite-1	Ethanol	30	Ave = 26	4 wt% EtOH, SS support, α of six different membranes ranged from 11 to 46	66
Silicalite-1	Ethanol	30	21	5 wt% EtOH, SS support, α reduced to 8 upon addition of 0.3 wt% succinic acid	88
Silicalite-1	Ethanol	32	11.5	9.7 wt% EtOH, alumina support, <15 torr	235
Silicalite-1 with PDMS coating	Ethanol	30	47–125	4 wt% EtOH, SS support, six samples with various PDMS coatings	176
Silicalite-1, silane treated	Ethanol	30 to 50	15–45	4 wt% EtOH, SS support, only observed α of 5 for untreated silicalite-1	236
Silicalite-1	Methanol	32	7.2	3.5 wt% MeOH, SS support	235
Silicalite-1	Methanol	32	2.5	3.5 wt% MeOH, alumina support	235
B-ZSM-5	Ethanol	30	31	5 wt% EtOH, alumina support	237
Ge-ZSM-5	Ethanol	30	47	5 wt% EtOH, SS support, Si/Ge = 41	238
Ge-ZSM-5	Methanol	30	36	5 wt% MeOH, SS support, Si/Ge = 41	238
Ge-ZSM-5	<i>n</i> -Butanol	30	19	5 wt% <i>n</i> -BuOH, SS support, Si/Ge = 41	238
Ge-ZSM-5	2-Propanol	30	29	5 wt% <i>i</i> -PrOH, SS support, Si/Ge = 41	238

SS: stainless steel.

membranes with few non-zeolite pores larger than the zeolite pores is over 100. In addition, fluxes observed with silicalite-1 membranes meet or exceed those of the thinnest PDMS films reported. As with inorganic membranes in other applications, silicalite-1 membranes are expected to be more expensive than polymer membranes on a unit area basis. However, silicalite-1 membranes may be cost effective on a per unit ethanol basis owing to the higher separation factor and flux afforded by the silicalite-1. Efforts to produce silicalite-based modules on a larger scale are ongoing including development of tubular silicalite-1 membranes at Bio-Nanotec Research Institute, Inc (BNRI, part of Mitsui & Co, Ltd, Tokyo, Japan) and of multi-channel monolithic membranes at CeraMem Corporation (Waltham, Massachusetts USA).

Due to the difficulty and cost of manufacturing defect-free commercial-scale silicalite-1 membranes, several groups have investigated the potential of mixed matrix membranes consisting of silicalite-1

particles dispersed in PDMS. In fact, a membrane of this type was, until recently, available commercially from Sulzer Chemtech (Neunkirchen, Germany). Table 5 lists alcohol–water separation factors reported in the literature for silicalite-PDMS mixed matrix membranes. The range of ethanol–water separation factors shown in the table, 7–59, overlaps the ranges reported for both PDMS and silicalite-1 alone. The performance of these mixed matrix materials is dependent on the loading of silicalite-1, size of the particles, source of silicalite-1, and membrane casting conditions. Although some performance gains have been observed with a loading as low as 30 wt% silicalite-1,¹⁷⁴ loadings of 60 wt% may be needed to deliver consistently high separation factors.^{83,175} Ikegami *et al* have combined PDMS and silicalite-1 in another manner to alter properties.^{88,176} Instead of dispersing silicalite-1 in PDMS, they coated the surface of a silicalite-1 membrane with a thin layer of PDMS to protect the silicalite-1 surface and

Table 5. Alcohol–water separation factors of silicalite–silicone rubber mixed matrix membranes

Alcohol	Temp (°C)	Silicalite loading (wt%)	Alcohol–water α	Notes (conc, flux, vacuum, active layer thickness)	Ref
Ethanol	22	77	59	7 wt% EtOH, 125 μm thick, <1 μm particles	215
Ethanol	22	77	34	5 wt% EtOH, 20 μm thick ^a , <1 μm particles	215
Ethanol	50	50	29.3	4.4 wt% EtOH, silicalite particles treated with acid and steam, α \uparrow if methyl ethoxy or methyl phenyl siloxanes used instead of PDMS	216
Ethanol	40	40	28	0.01 wt% EtOH in presence of aroma compounds	218
Ethanol	30	70	17	5 wt% EtOH, GE RTV615 PDMS, 1.8 μm particles, 100 μm thick, α \downarrow when temp \uparrow Note: ultrastable Y zeolite showed higher α and flux than silicalite	239
Ethanol	22.5	60	16.5	5 wt% EtOH, \sim 100 μm thick ^a , \sim 5 μm particles, GE 615 PDMS	214
Ethanol	22	62	13–16	7 wt% EtOH, 4–12 μm thick ^a , <1 μm particles	215
Ethanol	35	30	15.7	6 wt% EtOH, <2 torr, nanoscale silicalite, α = 15.3 and 14.3 at 50 and 65 °C, respectively	212
Ethanol	22.5	40	14.9	5 wt% EtOH, \sim 100 μm thick ^a , \sim 5 μm particles, GE 615 PDMS	214
Ethanol	66	NA	11.1	1.5 wt% EtOH, 10 torr vacuum	71
Ethanol	35	30	\sim 10	6 wt% EtOH	218
Ethanol	60	50	7.5	4.8 wt% EtOH, <40 μm particles, supported membrane	240
Ethanol	35	50	\sim 7	6 wt% EtOH, GFT (Sulzer) composite membrane	217
<i>n</i> -Butanol	30–70	Up to 70	40–140	Nanoscale silicalite dispersed in PDMS	241
<i>n</i> -Butanol	50	60	111	GE VTR615 silicone rubber, 0.1–0.2 μm particles, 19 μm thick ^a , 10 g dm ⁻³ butanol	83
<i>n</i> -Butanol	78	60	100–108	0.5–0.9 wt% <i>n</i> -BuOH, 3 μm silicalite particles dispersed in PDMS, 306 μm membrane, thinner membrane (170 μm) had only α = 30	57
<i>n</i> -Butanol	50	40	50	Sulzer Chemtech PERVAP-1070 membrane, 29 μm thick ^a	83
Methanol	22.5	60	13.09	5 wt% MeOH, \sim 100 μm thick ^a , \sim 5 μm particles, GE 615 PDMS	214
Methanol	30	?	3.6	Est at 5 wt% MeOH, Sulzer PERVAP-1070 membrane, 10 μm membrane	220
2-Propanol	22.5	60	23.0	5 wt% <i>i</i> -PrOH, \sim 100 μm thick ^a , \sim 5 μm particles, GE 615 PDMS	214

^a Supported on microporous support.

to fill defects, such as non-zeolitic pores, in the silicalite-1 layer. PDMS-coated silicalite-1 membranes delivered ethanol–water separation factors ranging from 47 to 125. Since mixed matrix membranes would be fabricated and used in much the same way as standard polymer membranes, the cost per unit area of mixed matrix membrane modules should also be similar to that of standard polymer membrane modules and, therefore, several times lower than that of inorganic membrane modules. The increased performance characteristics with little cost increase has led to the interest in mixed matrix membrane materials.

Future trends in pervaporation membranes

The preceding discussion and the data presented in Tables 2–5 provide a glimpse of the most attractive materials for the recovery of ethanol from water which are either currently available or under development. Similar observations have been made by others on the subject including: Aminabhavi *et al.*,¹⁷⁷ Dutta *et al.*,¹⁷⁸ Karlsson and Tragardh,¹⁷⁹ Zhang and Drioli,¹⁸⁰ Hickey and Slater,⁶⁴ and Blume *et al.*¹⁸¹ From these analyses it appears that PDMS will, at least for the near term, continue to be the dominant organic membrane material for the recovery of alcohols from

water. Development of silicalite-1-based membranes, both pure and in mixed matrix form, will continue, likely culminating in commercial membranes of this type available within 2–5 years. For all membranes discussed here, long term testing of those membranes and modules with actual process streams is required.

Alcohol recovery by vacuum membrane distillation

When porous membranes (*c.* 0.1 μm diameter pores) are used in conjunction with a vapor permeate, the purpose of the membrane is generally to provide a high surface area interface for evaporation. In this case, the name ‘vacuum membrane distillation’ is the most appropriate although some researchers have referred to this as ‘pervaporation’. Although conventional wisdom and the preponderance of experimental observations suggest that the best ethanol–water separation factor a VMD system can achieve will be that offered by the thermodynamic vapor–liquid equilibrium (α_{VLE}),^{54,55,79,182–184} Ghofar and Kokugan recently reported ethanol–water separation factors in excess of the α_{VLE} (reported to be 9.7 for ethanol–water) for VMD employing PTFE and PP microfiltration membranes.¹⁸⁵ In fact, they found that reducing membrane flux by increasing permeate pressure resulted in VMD ethanol–water separation factors

as high as 90. The stated theory for such high separation factors was the interaction between ethanol and the hydrophobic membrane materials. This is the first report of such high separation factors for VMD with porous membranes and will, therefore, require independent verification.

Effect of fermentation broth components on pervaporation membranes and modules

The literature contains several anecdotal observations regarding the impact, both positive and negative, of fermentation broth components on the performance of a variety of pervaporation membranes and modules.^{60,61,66,68,80,84,85,87,88,186,187} However, only a few of these attempted a systematic study to unravel the often overlapping effects of broth components on pervaporation membranes.^{68,84,87,88} To complicate matters, several studies have indicated no significant effect of fermentation broth on pervaporation performance of silicalite-1,⁸³ PDMS,^{80,188} mixed-matrix PDMS–silicalite,^{57,82} and even PTMSP membranes.⁸⁰ Broth components which *have* been mentioned as impacting pervaporation performance are listed in Table 6 along with the effect attributed to

their presence. The impact of each fermentation broth component on membrane performance is likely to be temperature-dependent since sorption, diffusion, evaporation, and precipitation are all temperature-dependent phenomena.

As noted in Table 6, organic acids such as acetic acid, butyric acid, succinic acid, and L-malic acid (L-hydroxy succinic acid) have been identified as negatively impacting the performance of silicalite-1.^{60,84,88,186} The cause of the performance decline is not yet understood. It might simply be a competitive sorption process in which the acids are preferentially sorbed relative to ethanol thereby blocking ethanol transport and making the silicalite-1 more hydrophilic—a reversible phenomenon. However, an irreversible interaction between the acids and reactive sites in the zeolite may also occur. An irreversible reaction between organic acids and aluminum groups in some preparations of silicalite-1 has been proposed.¹⁸⁶ In any event, only the protonated form of the acid is expected to be of importance. The pH of the broth and the acid dissociation constant(s) (pK_a) of the acids thus determine the magnitude of any impact of acids on silicalite-1. The pK_a values for four organic acids

Table 6. Components of a biofuel fermentation broth which might impact pervaporation system performance

Broth component or property	Max concentration (g dm ⁻³)	Effect on pervaporation membrane or module
Viable and dead whole cells		Potential to accumulate in modules, blocking flow path and membrane surface
Suspended solids		Same as above
Cell components (such as proteins, cell wall, etc)		Same as above, especially if materials precipitate when heated, lipid adsorption mentioned for PTMSP ⁶⁸
Glucose	100	Glucose and lactose ↓ water flux and, to a lesser extent, ↓ ethanol flux, therefore ethanol–water α ↑ ⁶⁶
Xylose	50	Likely to have a similar effect as glucose
Organic acids (pK_a):		Silicalite-1: reduced flux and selectivity observed in presence of acetic and succinic acids although other reports indicate no effect of acetic or butyric acids
• Acetic acid (4.74)	1	
• L-Malic acid (3.40/5.05)	1	
• Succinic acid (4.21/5.64)	4	
• Butyric acid (4.82)	0.5	
Dissolved solids (NaCl)	10	PDMS: may increase γ for ethanol and therefore ethanol flux, no problem unless they precipitate at elevated temperatures
Glycerol	10	PDMS: same as for dissolved solids Silicalite-1 with PDMS coating: glycerol may reduce flux ⁸⁴
Main fermentation products:		PDMS membranes: ↑ alcohol concentration tends to ↑ permeability of both water and the alcohol, with the former affected more, therefore, alcohol–water α ↓
• Ethanol	100	
• Acetone	10	
• <i>n</i> -Butanol	20	Silicalite-1: due to competitive sorption and hindered transport, ↑ alcohol concentration tends to ↑ α
• 2-Propanol	5	
Side-product alcohols:		Polymer membranes: may lead to swelling of membrane which could reduce alcohol–water α
2,3-butanediol	0.5	Silicalite-1: due to competitive sorption and hindered transport, butanediol may impede both ethanol and water permeation, thereby reducing flux
pH	pH range 3–6	No direct effect, secondary effect through the fraction of organic acid which is protonated and, therefore, in volatile form
Fatty acids	0.15	PTMSP: 10-fold reduction in butanol flux and selectivity observed when sodium stearate or sodium palmitate added to feed ⁶⁸
• Stearic acid		
• Palmitic acid		

Note: ↓ refers to 'decreasing' or 'decreases' and ↑ refers to 'increasing' or 'increases'.

are provided in Table 6. The first acid constants for these materials range from 3.4 to 4.8. These values are at or below the typical pH of a fermentation broth, indicating that at least a portion of the organic acids will be present as deprotonated anions. Increasing the pH within the typical yeast fermentation pH range of 4–6 can be used to significantly reduce the amount of acid in protonated form. For example at a pH of 4, the fractions of succinic acid and acetic acid which are protonated are 61 and 85%, respectively. However, at a pH of 6, the fraction protonated drops to 0.5 and 5% for succinic acid and acetic acid, respectively. Despite the fact that feed solution pH appears to be a critical parameter for assessing the impact of organic acids on pervaporation membranes, the pH of the feed solution is rarely controlled or even reported in the literature.

Fermentation broth components may also alter the thermodynamic behavior of alcohols. For example, simply adding more salt to the broth will increase the activity coefficient of the alcohol such that the alcohols prefer to partition out of the water phase and into the membrane.¹⁸⁹ The activity of water is also a function of dissolved species thereby impacting observed membrane separation factors.¹⁸⁹ Nakano *et al* investigated the impact of sodium citrate, sodium lactate, ammonium citrate tribasic, glycerin, glucose, and xylose on the vapor–liquid partitioning of several alcohols including ethanol.¹⁹⁰ Only glucose and xylose did not impact the VLE behavior of the alcohols. Each of the other species measurably increased the activity coefficient of the alcohols. Given all of the uncertainty, it is apparent that additional experimental observations are needed to understand the impact of broth components on pervaporation performance. As external and internal membrane foulants are identified, engineering controls and cleaning protocols will be developed to minimize the impact of the foulants in much the same way as protocols have been established for filtration systems.

Energy considerations

In the ‘Fundamentals of Pervaporation’ section, the energy required to evaporate and then condense permeating species was briefly introduced. In this section, the effect of membrane performance characteristics, process configurations, feed composition, and desired separation requirements will be discussed as they relate to the energy efficiency of pervaporation. The energy required to evaporate permeate in a pervaporation process, normalized per unit of ethanol permeated, ($Q_{\text{norm}}^{\text{evap}}$) is calculated as follows:

$$Q_{\text{norm}}^{\text{evap}} = \frac{\sum_i H_i^{\text{evap}} \mathcal{J}_i}{\mathcal{J}_{\text{EtOH}}} \quad (7)$$

where H_i^{evap} is the heat of evaporation of species i . When ethanol and water dominate the feed and the

permeate, eqn (7) can be rewritten in terms of the ethanol–water separation factor (α) as:

$$\begin{aligned} Q_{\text{norm}}^{\text{evap}} &= H_{\text{EtOH}}^{\text{evap}} + H_{\text{w}}^{\text{evap}} \left(\frac{C_{\text{w}}^{\text{L}}}{\alpha C_{\text{EtOH}}^{\text{L}}} \right) \\ &= H_{\text{EtOH}}^{\text{evap}} + H_{\text{w}}^{\text{evap}} \left(\frac{C_{\text{T}} - C_{\text{EtOH}}^{\text{L}}}{\alpha C_{\text{EtOH}}^{\text{L}}} \right) \end{aligned} \quad (8)$$

The heat which must be removed in order to condense the permeate vapor is approximately the same as the heat required for the evaporation step (ie $Q_{\text{norm}}^{\text{cond}} = -Q_{\text{norm}}^{\text{evap}}$). Ideally, the heat released during condensation can be used to provide the heat of evaporation. Due to heat transfer resistances and the difference between the temperatures of the feed liquid and the permeate condensate necessary to maintain a permeate pressure driving force, the heat released during condensation cannot be directly used to heat the feed liquid. When pervaporation is operated at an elevated feed temperature, the temperature of the permeate condenser may also be elevated relative to ambient temperatures. Thus, the heat released during condensation can be removed with a simple forced air heat exchanger, requiring little energy input. Under these circumstances, the heat of evaporation is the dominant energy sink in the pervaporation process.

However, heat pumps can be employed to upgrade the heat released during condensation of the permeate.^{191–199} The conceptual incorporation of a closed-cycle heat pump with a pervaporation system is shown in Fig 5. The evaporator portion (cold side) of the heat pump is linked to the condensers of the pervaporation system while the condenser portion (hot side) of the heat pump is linked to the feed liquid heaters of the pervaporation system. Heat pump efficiency is reported as the Coefficient Of Performance (COP) which is the ratio of the delivered useful energy to the energy input to the heat pump compressor (the latter is sometimes referred to as the purchased energy).¹⁹⁵ A standard closed-cycle heat pump can be expected to produce evaporation quality heat from the heat of condensation using an energy input equal to one-quarter to one-third or less of the evaporation energy yielding a COP of 3–4. Mechanical vapor recompression (MVR) heat pumps are capable of COP values as high as 8, but are limited to situations where the process vapor (permeate in this case) is the working fluid of the heat pump.

More efficient condensation schemes can also be used to increase the energy efficiency of pervaporation systems. Until recently, the separation performance of a pervaporation system was solely determined by transport through the membrane. For the ethanol–water system, since the permeate product typically contained ethanol at less than 30 wt%, this meant that the condensed permeate would require additional processing, most likely with distillation, in order to concentrate the ethanol to the azeotrope; followed by dehydration

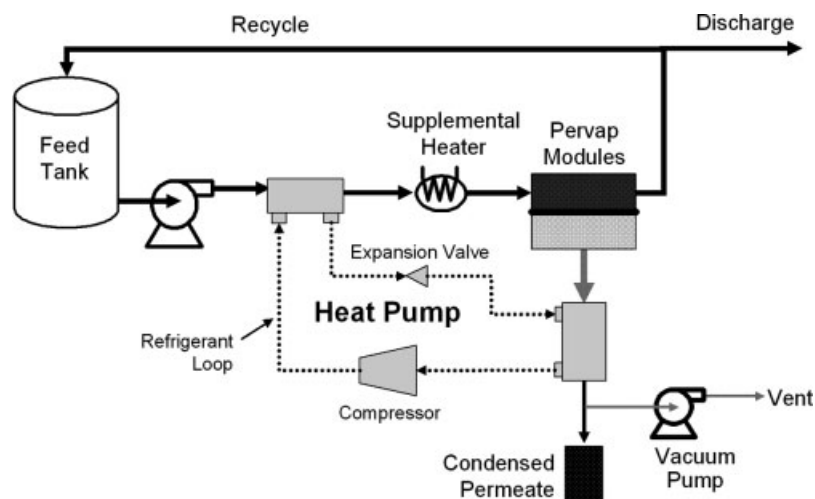

Figure 5. Illustration of integrating a closed-cycle heat pump into a pervaporation system.

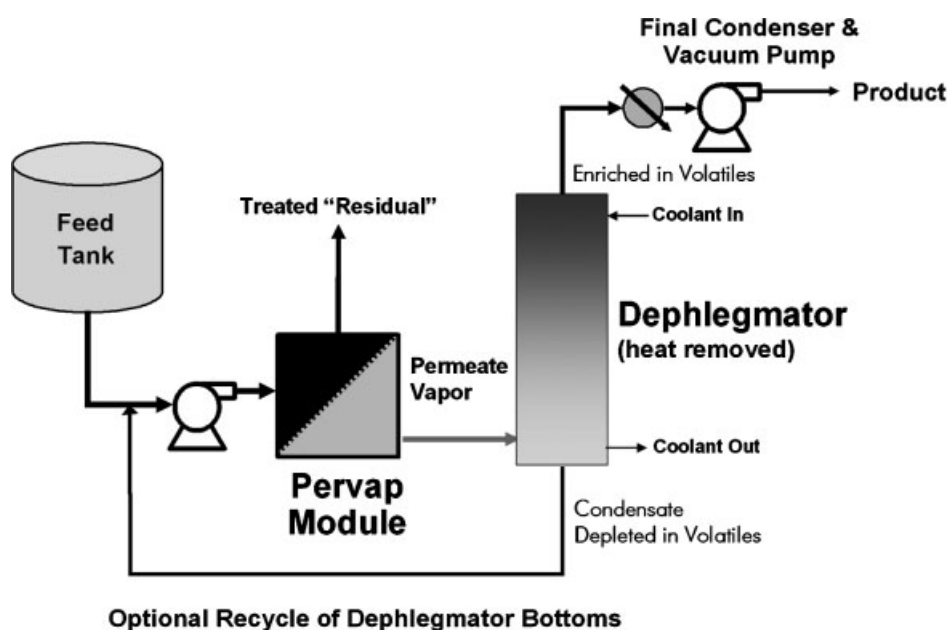

Figure 6. Schematic diagram of process combining dephlegmation fractional condenser with pervaporation module.

to meet fuel specifications. However, a joint invention of the USEPA and Membrane Technology and Research, Inc enables the final condensed ethanol product from the pervaporation system to be at or above the normal azeotropic composition.^{200,201} In this invention, as depicted in Fig 6, the permeate vapor is fed into a dephlegmator fractional condenser before passing to the final complete condenser. In the dephlegmator, a rising vapor is contacted with a falling condensate to generate temperature and concentration gradients in the column. The column contains a high surface area material to enable efficient mass transfer, establishing multiple VLE stages. No reboiler is employed and the condensate is generated either from an overhead condenser or by operation of the dephlegmator as a countercurrent heat exchanger. For process simulation purposes, the dephlegmator can be modeled as a distillation column with a vapor

feed to the bottom stage and no reboiler. In the case of ethanol–water vapors, water is preferentially condensed in the dephlegmator and leaves as a bottoms condensate while an ethanol-enriched vapor leaves the top of the dephlegmator and enters a complete condenser. The result is a condensed ethanol product containing 90+ wt% ethanol which can be directly dehydrated. The ethanol-depleted dephlegmator bottoms condensate can be recycled to the pervaporation feed stream so no ethanol is lost due to addition of the dephlegmator. In this way, distillation is no longer needed. This improvement can be achieved with a passive packed column. Other than operation of a liquid reflux pump and dephlegmator bottoms condensate pump, no additional energy is required for operation of the dephlegmator relative to that of the traditional complete condenser. Thus, pervaporation with hydrophobic membranes competes directly

with distillation for the production of azeotropic mixtures of ethanol and water from dilute ethanol–water solutions, such as fermentation broths.

Just as distillation systems for recovering ethanol from fermentation broths have become more energy efficient through heat integration, so too will pervaporation systems. Due to the dilute nature of fermentation broths and poor heat integration, older distillation systems required more energy to recover ethanol from the broths than could be released through combustion of the ethanol recovered. Newer distillation system designs require significantly less energy per unit ethanol than older distillation systems.^{24,202} However, even with the most efficient designs, the net energy required for distillation exceeds that contained in the ethanol when ethanol concentrations in the broth are less than 1 wt%. In addition, the complexity required to obtain efficient distillation does not scale down well. For example, a schematic diagram of a heat-integrated distillation system for ethanol recovery from fermentation broths is shown in Fig 7 (figure from Ref 203). Such a system as that depicted in Fig 7 is economical at a large scale, but may not be economical at a smaller scale.

Using data provided by Madson and Lococo (scenario 'C') and Galbe and Zacchi, the energy required to recover ethanol using a heat-integrated distillation system as a function of the concentration of ethanol in the feed solution was calculated.^{24,202} In these references, the ethanol concentration in the bottoms residual stream was assumed to be constant

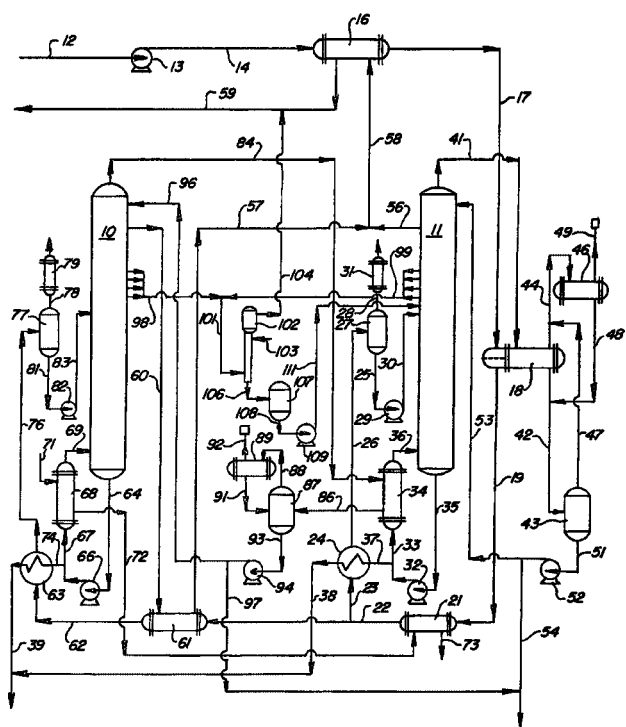

Figure 7. Schematic diagram of a heat-integrated distillation system consisting of two stripper-rectifier towers (labeled 10 and 11) operated at different pressures (from US Patent 4,306,942, Ref 203). Note: Units labeled 16, 18, 21, 24, 34, 46, 61, 63, 68, and 89 represent heat exchange devices necessary to achieve heat integration.

at 0.02 wt% and the overhead product contained 95 vol% (~93 wt%) ethanol. The range of energy requirements from these two references is shown in Fig 8a as a gray zone. Energy requirements for pervaporation were calculated according to eqn (8) for a range of ethanol–water separation factors. No condensation heat recovery was assumed. As with the distillation estimates, the residual ethanol concentration was fixed at 0.02 wt%. It was further assumed that a dephlegmator was coupled with the pervaporation system to enrich the permeate to a product concentration of 93 wt% requiring no additional energy (as was described earlier). In these calculations, the log-mean ethanol concentration was used to represent the ethanol concentration in the pervaporation system. Pervaporation energy requirements thus calculated for ethanol–water separation factors of 8, 10, 20 and 50 are shown in Fig 8a. As noted previously, traditional silicone rubber membranes can be expected to deliver a separation factor of between 8 and 10. As shown in Fig 8a, without condensation heat recovery, the energy required to recover ethanol by pervaporation for $\alpha = 8$ or 10 exceeds the energy of combustion of the recovered ethanol for ethanol feed concentrations up to about 5 wt%. Therefore, condensation heat recovery may be critical for such systems. Hydrophobic zeolite membranes can be expected to exhibit ethanol–water separation factors between 40 and 80. For such separation factors, pervaporation without heat recovery is as efficient, or more so, than the distillation systems.

Recovery of condensation heat in pervaporation systems alters the above conclusions. For example, Fig 8b presents the pervaporation energy usage using the same calculation parameters as for Fig 8a, but assuming a 67% reduction in pervaporation energy usage through energy recovery (for example, if a

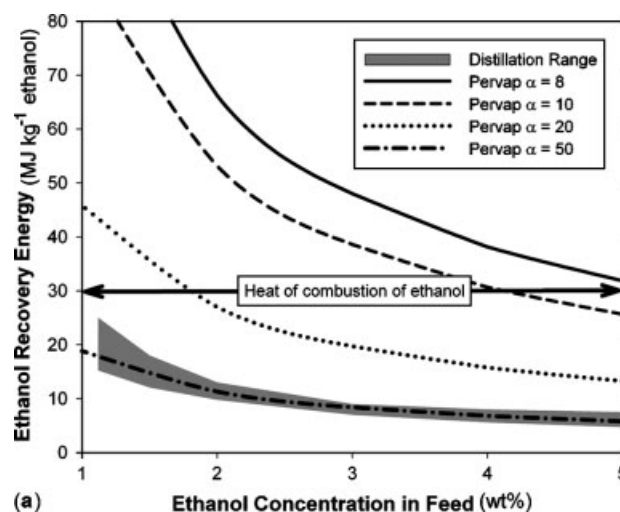

Figure 8a. Energy required to recover ethanol from water as a function of the ethanol concentration in the feed stream for two heat-integrated distillation systems and pervaporation systems at several ethanol–water separation factors. Distillation values from Ref 202 (design 'C') and Ref 24. No condensation heat recovery was used for the pervaporation scenarios. All scenarios treat residual down to 0.02 wt% ethanol and deliver 93 wt% ethanol product.

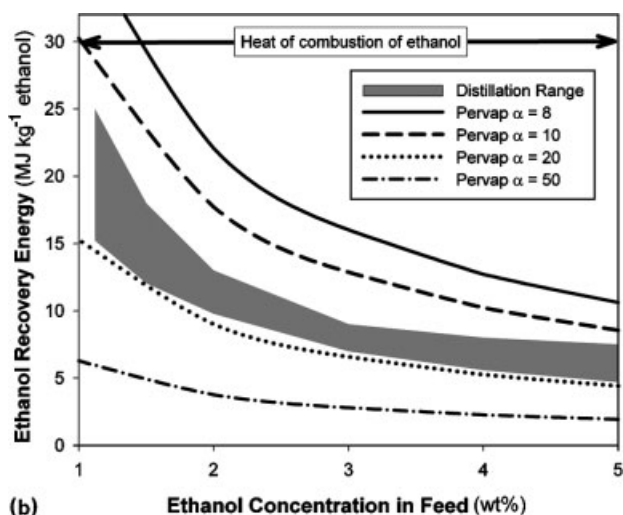

Figure 8b. Same as Fig 8a except condensation heat recovery was assumed to reduce pervaporation energy usage by 67%.

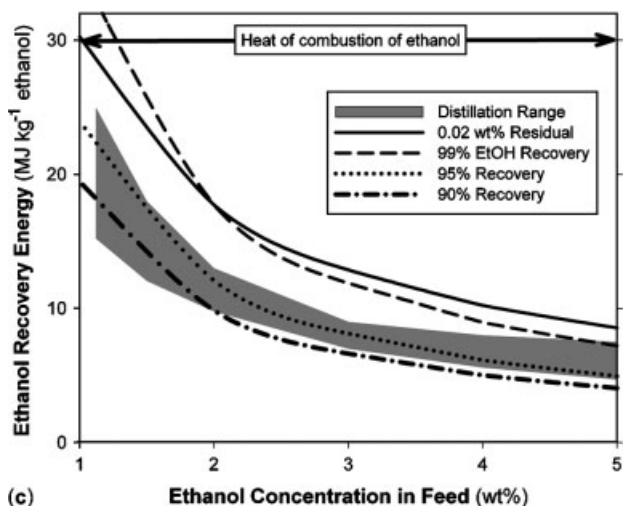

Figure 8c. Same as Fig 8b except the pervaporation ethanol-water separation factor is fixed at 10 but the fractional recovery of ethanol allowed to vary.

COP = 3 heat pump was employed). Note that the distillation values shown in Fig 8b are the same as in Fig 8a. As shown in Fig 8b, except for $\alpha = 8$ at concentrations below 1.5 wt% ethanol, heat-integrated pervaporation systems require less energy than is contained in the recovered ethanol for all of the separation factors analyzed. This analysis further predicts that pervaporation systems incorporating condensation heat recovery with $\alpha \geq 15$ are more efficient than heat-integrated distillation systems.

The analyses presented in Figs 8a and 8b used a fixed residual concentration of 0.02 wt% (0.2 g dm^{-3}). As a result, the fraction of ethanol recovered in each scenario increases from 0.98 to 0.996 as the feed ethanol concentration increases from 1 to 5 wt%. Although the energy required for distillation and capital costs are not a strong function of recovery in this range of concentrations, the same cannot be said for pervaporation systems. In fact, pervaporation systems are often best analyzed in terms of a fixed recovery

since membrane area (and thus capital cost) is linked more to the fraction of a compound removed than to the absolute value of the concentrations, as suggested by eqn (5). Thus, it is informative to investigate the effect of ethanol recovery on energy usage in pervaporation. To this end, calculations similar to those used to generate the pervaporation curves in Fig 8b for pervaporation systems incorporating condensation heat recovery were carried out for fixed ethanol recoveries of 90, 95, and 99% assuming an ethanol-water separation factor of 10. The distillation range shown in Figs 8a and 8b is again provided for reference in Fig 8c as is the pervaporation curve for $\alpha = 10$ with condensation heat recovery from Fig 8b where recovery increases from 98 to 99.6% because the residual is fixed at 0.02 wt% ethanol. As might be expected, energy usage for the 99% recovery scenario is similar to that of the fixed 0.02 wt% residual scenario since the recoveries overlap. Energy usages for 95% and 90% recoveries are appreciably lower, indicating that efficiency gains can be achieved if lower ethanol recoveries (ie higher residual ethanol concentrations) are acceptable. In fact, a number of scenarios involving the application of pervaporation to remove inhibitory fermentation products involve operating with single-pass recoveries of less than 50%.

Several conclusions can be made from the analysis presented in Figs 8a, 8b and 8c. First, using heat-integrated distillation systems as a benchmark and requiring a residual ethanol concentration of 0.02 wt%, pervaporation systems with ethanol-water separation factors greater than 15 are required to improve upon the benchmark if condensation heat recovery is employed while separation factors greater than 40 are required if condensation heat recovery is not employed. If the residual ethanol requirement is relaxed (or if the ethanol recovery requirement is reduced), then even pervaporation systems with separation factors of 8 or 10 are sufficiently energy efficient while still maintaining ethanol recoveries in excess of 90%. Mention of the major assumptions and limitations of this analysis is in order. First, it has been assumed that the energy required for evaporation and condensation of the permeate represents the total energy requirement in the pervaporation system. This is generally the case. However, other energy requirements, such as that required for liquid and vacuum pumps, will become more significant, in a relative sense, as the magnitude of the evaporation and condensation energies is reduced through heat integration or when employing a membrane with a higher separation factor. Thus, the values presented in Figs 8a, 8b and 8c should be considered approximations and used only to identify general trends. Second, the distillation data from the two references have been assumed to represent a typical heat-integrated distillation system.

This analysis did not venture into the area of engineering costs, looking only at rough energy requirements. Even a pervaporation system which uses

more energy to produce ethanol than is contained in the ethanol could be economically viable if the cost of energy is low (for example if waste steam heat is available). As stated previously, the distillation energy usages presented in Figs 8a, 8b and 8c represent heat-integrated designs which may not be economically practical at smaller scales. As a result, a full engineering cost analysis of the options should be performed for the particular situation before selecting an ethanol recovery process.

Due to the higher inhibitory effect of butanol on acetone–butanol–ethanol (ABE) fermentative microorganisms and the resulting lower concentration of biofuels in an ABE broth, the impact of coupling a solvent recovery stage with an ABE fermentor is more significant. In addition, the energy picture for the recovery of biofuels from ABE fermentations is much more attractive for pervaporation because of the high butanol–water separation factor and the liquid–liquid phase separation offered by the *n*-butanol/water system.^{204–206} Matsumura *et al* compared *n*-butanol recovery by pervaporation using an oleyl alcohol liquid membrane followed by distillation to that of distillation alone.²⁰⁵ For a broth containing 0.5 wt% *n*-butanol, the pervaporation–distillation system required 7.4 MJ per kilogram of *n*-butanol recovered while the distillation only system required ten times as much energy (79.5 MJ kg-BuOH⁻¹).

Dehydration of condensed permeate

The ethanol product from an ethanol recovery pervaporation system must be dehydrated to meet fuel specifications. Based on the fuel ethanol standard established in ASTM D4806,⁹¹ fuel ethanol may contain up to 1 vol% (0.8 wt%) water. Thus, a reasonable target for the pervaporation dehydration retentate would be 0.5 wt% water. If a dephlegmator

is coupled with the pervaporation system, then the pervaporation–dephlegmator product will contain on the order of 95 wt% ethanol and the subsequent dehydration step must reduce water content from 5 to 0.5 wt%. In this situation, the competing technologies are pervaporation with hydrophilic membranes and molecular sieve sorption. When pervaporation is used for alcohol recovery from the fermentation broth, economic synergies can be realized if the dehydration is also performed by pervaporation since the permeate infrastructure is already in place. This is schematically illustrated in Fig 9. As depicted in the figure, the permeate vapor from the dehydration pervaporation modules would be processed by the same dephlegmator, condenser, and vacuum pump as the permeate from the alcohol recovery pervaporation modules. The quantity of water removed by the dehydration modules is small compared to the quantity of water in the original permeate from the alcohol recovery modules. As a result, the size and cost of the permeate infrastructure is only marginally changed by addition of permeate from the dehydration modules. Such a scheme enables the use of dehydration membranes with lower water–ethanol separation factors since the ethanol which is ‘lost’ to the permeate is recovered in the dephlegmator–condenser system. Since flux and selectivity are often inversely correlated, the lower selectivity membranes should deliver high water fluxes and require less area to produce dehydrated ethanol.

Economic studies

Several groups have calculated the engineering costs for pervaporation systems recovering alcohols from fermentation broths.^{7,78,81,207–209} The most recent of these was published in 2002 and the oldest in 1984. Comparison of these six studies is not straightforward

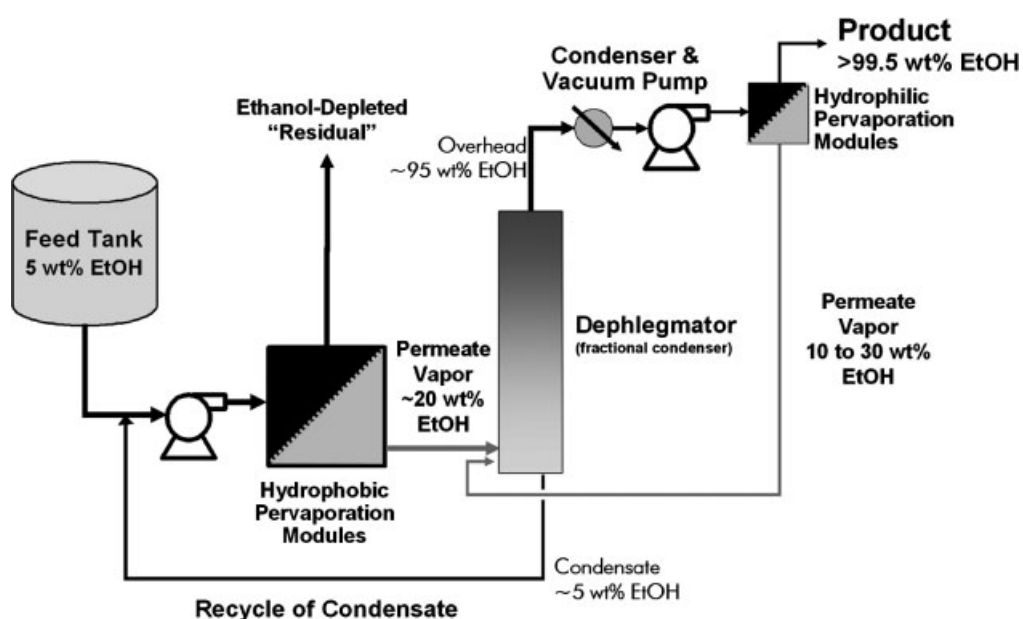

Figure 9. Schematic diagram illustrating the synergy of employing pervaporation for both ethanol recovery and product dehydration using the same permeate processing system.

because of the many different assumptions employed. In addition, each study represents a snapshot in the development of an emerging technology. As a result, the studies are almost immediately obsolete. Nevertheless, such studies are critical to understanding the issues associated with a technology and help to focus research and development efforts on issues with the most significance to the commercial success of the technology.

In all but one of these six studies, silicone rubber was assumed to be the selective layer in the membrane. Three of these were for the recovery of ethanol from water and separation factors of 10, 10.3, and 11.7 were applied.^{78,208,209} Two of the cost analyses involved butanol–water systems and both used silicone rubber as the membrane material with assumed butanol–water separation factors of 50⁷ and 30.²⁰⁷ In the remaining case, the exact material was not stated, but reference was made to a zeolite–silicone rubber mixed matrix material which enabled the authors to use a more optimistic ethanol–water separation factor of 20.⁸¹

In most published articles documenting engineering cost analyses, not all of the equations and assumptions used in the analyses are provided due to space limitations or oversight. Such is the case for the six alcohol recovery pervaporation studies where incomplete information is provided to reproduce the calculations or for the reader to apply new assumptions. For example O'Brien *et al*, in what appears to be the most complete analysis, do not mention the membrane area they calculated that would be required to produce the 50 MGY (189 MLY or 17 300 kg h⁻¹) of ethanol.²⁰⁸ According to Dr O'Brien, a membrane area of 2.99 × 10⁵ m² was used in the calculations and this area was based on a total flux of 0.15 kg m⁻² h⁻¹ (42 wt% ethanol in the permeate) and 330 days of operation per year (O'Brien, personal communication, 2004). Even with this scale of system, it was concluded that pervaporation coupled with fermentors (with distillation of the condensed pervaporation permeate) was on the verge of being cost competitive with distillation alone. Only modest improvements in ethanol–water separation factor and/or flux would tip the scales in favor of pervaporation as would a reduction in the cost of the membrane units. Given the analyses provided herein, it should be clear that operation of the pervaporation system at a higher temperature will increase flux by a factor of 5–10 and that separation factor improvements of 2× to even 6× could be possible in the near future which, according to O'Brien *et al*, would make a pervaporation–fermentation system an attractive option. As noted by O'Brien *et al*, knowledge of the true cost of pervaporation systems is lacking. For example, the membrane costs of \$200 m⁻² for modules with housings and \$100 m⁻² for replacements and the 5 year lifetime assumed by O'Brien *et al* each seem, to this author, to be optimistic by a factor of about

2. Yet, given the state of the technology and lack of cost information, one person's assumptions are just as valid as another's. To accommodate for the imprecise nature of membrane cost and performance data, O'Brien *et al* and others performed sensitivity analyses on these parameters to elucidate the impact they have on production costs.

Despite the vagaries associated with the cited economic studies, each determined pervaporation to be either the low-cost option or on the verge of competitiveness. The four main issues which emerge from the studies as leading to the improved positioning of pervaporation are increased fluxes, increased separation factor, increased membrane/module lifetime, and reduced cost per unit membrane area. These issues are universal to all membrane processes. Given the ability of other membrane processes, like reverse osmosis, to overcome similar challenges and become competitive with traditional technologies, it can be projected that pervaporation, too, has the potential to achieve technical acceptance and commercial success.

CONCLUSIONS

Pervaporation is an emerging technology with significant potential to efficiently recover alcohols and other biofuels from fermentation broths. As reviewed here, a number of studies have investigated this application, reporting on new membranes, new modules, pervaporation–fermentation integration issues, energy issues, fouling, and costs. Several issues must be addressed for pervaporation to be economically viable and enlisted for biofuel recovery:

- (1) Increased energy efficiency:
 - (a) Improved ethanol–water separation factor
 - (b) Heat integration/energy recovery
- (2) Reduction of capital cost for pervaporation systems:
 - (a) Reduction in the membrane/module cost per unit area
 - (b) Increasing membrane flux to reduce required area
- (3) Longer term trials with actual fermentation broths to assess membrane and module stability and fouling behavior
- (4) Optimized integration of pervaporation with fermentor:
 - (a) Filtration (MF or UF) to increase cell density in fermentor and allow higher pervaporation temperatures
 - (b) Removal/avoidance of inhibitors
- (5) Synergy of performing both alcohol recovery and dehydration by pervaporation with dephlegmation fractional condensation technology
- (6) Updated economic analyses of pervaporation which provide comparisons to competing technologies on even bases at various biofuel production scales

As part of our research and development activities into the sustainable production of biofuels, the USEPA's Pervaporation Team will be contributing to four industry-led, US government-funded research projects which seek to address the issues outlined above. The first project is a two-year effort led by CeraMem Corporation to develop high performing (high flux and selectivity), large area monolithic ceramic membranes with an alcohol-selective silicalite-1 layer. The effect of actual fermentation broths on performance will be a part of this study. This first project primarily addresses issues 1, 2, and 3 above. The second project, led by Membrane Technology and Research, Inc, involves the development of high flux dehydration membranes and ways in which the dehydration system can be integrated with the alcohol recovery pervaporation unit (issue 5 above). The third project is a two-year effort, also led by Membrane Technology and Research, Inc, which will examine implementation and cost issues related to employing pervaporation for ethanol recovery from biomass conversion to ethanol at modest ethanol production levels—at least an order of magnitude smaller than typical corn-to-ethanol operations. In this effort, a consortium of groups covering food/beverage producers (biomass generators), separation technology companies, and government researchers hope to make progress in each of the six issues identified above. In the fourth project, a consortium led by BC International, Corp will attempt to scale biofuel production down even further to assess whether waste materials generated by forward military units can be converted into liquid fuels and heat/steam in an energy efficient manner to support the needs of those units. The results of these four projects combined with the results of other ongoing pervaporation research and development projects will most certainly move the technology closer to maturity.

DISCLAIMER

The mention of trade names or commercial products does not constitute an endorsement or recommendation for use. Any unreferenced costs provided herein are the author's estimates and should not be relied upon to develop system costs. As always, the reader is advised to contact the vendor for pricing for the specific application being considered.

ACKNOWLEDGEMENTS

The author wishes to thank his USEPA colleagues Lauren Drees, Travis Bowen, Vasudevan Namboodiri, and Franklin Alvarez for their reviews of this manuscript.

REFERENCES

- Shapouri H, Duffield JA and Grabonski MS, Estimating the net energy balance of corn ethanol. US Department of Agriculture, Agricultural Economic Report # 721 (1995).
- Shapouri H, Duffield JA and Wang M, The energy balance of corn ethanol: an update. US Department of Agriculture, Agricultural Economic Report # 814 (2002).
- Sosulski K, Alternatives for management of pulp and paper industry solid wastes: production of ethanol. NCASI Technical Bulletin. National Council of the Paper Industry for Air and Stream Improvement, Inc, New York, NY (1994).
- Yacobucci BD and Womach J, Fuel ethanol: background and public policy issues. Congressional Research Service Report for US Congress, RL30369 (2003).
- Jeffries TW and Schartman R, Bioconversion of secondary fiber fines to ethanol using counter-current enzymatic saccharification and co-fermentation. *Appl Biochem Biotechnol* 77–79:435–444 (1999).
- Maddox IS, Qureshi N and Gutierrez NA, Utilization of whey by Clostridia and process technology, *The Clostridia and Biotechnology*, ed by Woods DR. Butterworth-Heinemann, Stoneham, pp 343–369 (1993).
- Schoutens GH and Groot WJ, Economic feasibility of the production of iso-propanol–butanol–ethanol fuels from whey permeate. *Proc Biochem* 8:117–121 (1985).
- Wayman M, Chen S and Doan K, Bioconversion of waste paper to ethanol. *Proc Biochem* 27:239–245 (1992).
- Ennis BM, Marshall CT, Maddox IS and Paterson AHJ, Continuous product recovery by in-situ gas stripping/condensation during solvent production from whey permeate using *Clostridium acetobutylicum*. *Biotechnol Lett* 8:725–730 (1986).
- Maddox IS, Qureshi N and Roberts-Thomson K, Production of acetone–butanol–ethanol from concentrated substrates using *Clostridium acetobutylicum* in an integrated fermentation–product removal process. *Proc Biochem* 30:209–215 (1995).
- Qureshi N and Manderson GJ, Bioconversion of renewable resources into ethanol: an economic evaluation of selected hydrolysis, fermentation, and membrane technologies. *Energy Sources* 17:241–265 (1995).
- Lynd LR, Overview and evaluation of fuel ethanol from cellulosic biomass: technology, economics, the environment, and policy. *Annu Rev Energy Environ* 21:403–465 (1996).
- Kadam KL, Wooley RJ, Aden A, Nguyen QA, Yancey MA and Ferraro FM, Softwood forest thinnings as a biomass source for ethanol production: a feasibility study for California. *Biotechnol Prog* 16:947–957 (2000).
- Kim S and Dale BE, Global potential bioethanol production from wasted crops and crop residues. *Biomass and Bioenergy* 26:361–375 (2004).
- Korkie LJ, Janse BJH and Viljoen-Bloom M, Utilising grape pomace for ethanol production. *S Afr J Enol Vitic* 23:31–36 (2002).
- BBi International, Economic impact assessment for ethanol production and use in Hawaii (draft report) (2003).
- Lynd LR, Lyford K, South CR, van Walsum P and Levenson K, Evaluation of paper sludges for amenability to enzymatic hydrolysis and conversion to ethanol. *Tappi J* February: 1–19 (2001).
- Graf A and Koehler T, Oregon cellulose–ethanol study: an evaluation of the potential for ethanol production in Oregon using cellulose-based feedstocks. A report prepared by Bryan & Bryan, Inc under contract to Oregon Office of Energy (2000).
- Wooley RJ, Ruth M, Glassner D and Sheehan J, Process design and costing of bioethanol technology: a tool for determining the status and direction of research and development. *Biotechnol Prog* 15:794–803 (1999).
- Maiorella BL, Blanch HW and Wilke CR, Economic evaluation of alternative ethanol fermentation processes. *Biotech Bioeng* 26:1003–1025 (1984).
- Wyman CE, Biomass ethanol: technical progress, opportunities, and commercial challenges. *Annu Rev Energy Environ* 24:189–226 (1999).

- 22 Ingram LO, Aldrich HC, Borges ACC, Causey TB, Martinez A, Morales F, Saleh A, Underwood SA, Yomano LP, York SW, Zaldivar J and Zhou S, Enteric bacterial catalysts for fuel ethanol production. *Biotechnol Prog* 15:855–866 (1999).
- 23 Abbasi SA and Abbasi N, The likely adverse environmental impacts of renewable energy sources. *Applied Energy* 65:121–144 (2000).
- 24 Galbe M and Zacchi G, A review of the production of ethanol from softwood. *Appl Microbiol Biotechnol* 59:618–628 (2002).
- 25 Wheals AE, Basso LC, Alves DMG and Amorim HV, Fuel ethanol after 25 years. *Trends Biotechnol* 17:482–487 (1999).
- 26 Lark N, Xia Y, Qin C-G, Gong CS and Tsao GT, Production of ethanol from recycled paper sludge using cellulase and yeast, *Kluveromyces marxianus*. *Biomass and Bioenergy* 12:135–143 (1997).
- 27 Fan Z, South C, Lyford K, Munsie J, van Walsum P and Lynd LR, Conversion of paper sludge to ethanol in a semicontinuous solids-fed reactor. *Bioprocess Biosyst Eng* 26:93–101 (2003).
- 28 Kerstetter JD, Lynd LR, Lyford K and South C, Assessment of potential for conversion of pulp and paper sludge to ethanol fuel in the Pacific Northwest. Subcontract No ACG-6-15177-01. Report prepared for National Renewable Energy Laboratory (1997).
- 29 Profile of the Pulp and Paper Industry, 2nd edn. US Environmental Protection Agency, EPA Office of Compliance Sector Notebook. EPA/310-R-02-002 (2002).
- 30 Taylor F, Kurantz MJ, Goldberg N and Craig JC, Jr, Effects of ethanol concentration and stripping temperature on continuous fermentation rate. *Appl Microbiol Biotechnol* 48:311–316 (1997).
- 31 Gapes JR, Nimcevic D and Friedl A, Long-term continuous cultivation of *Clostridium beijerinckii* in a two-stage chemostat with on-line solvent removal. *Appl Environ Microbiol* 62:3210–3219 (1996).
- 32 Taylor F, Kurantz MJ, Goldberg N and Craig JC, Jr, Continuous fermentation and stripping of ethanol. *Biotechnol Prog* 11:693–698 (1995).
- 33 Taylor F, Kurantz MJ, Goldberg N and Craig JC, Jr, Kinetics of continuous fermentation and stripping of ethanol. *Biotechnol Lett* 20:67–72 (1998).
- 34 Durre P, New insights and novel developments in clostridial acetone/butanol/isopropanol fermentation. *Appl Microbiol Biotechnol* 49:639–648 (1998).
- 35 Groot WJ, van der Lans RGJM and Luyben KChAM, Technologies for butanol recovery integrated with fermentations. *Proc Biochem* 27:61–75 (1992).
- 36 Ennis BM, Gutierrez NA and Maddox IS, The acetone–butanol–ethanol fermentation: a current assessment. *Proc Biochem* 21:131–147 (1986).
- 37 Belafi-Bakao K, Harasek M and Friedl A, Product removal in ethanol and ABE fermentations. *Hungarian J Ind Chem* 23:309–319 (1995).
- 38 Park CH and Geng Q, Simultaneous fermentation and separation in the ethanol and ABE fermentation. *Sep Purif Methods* 21:127–174 (1992).
- 39 Park C-H and Janni K, Recent progress in simultaneous fermentation and separation of alcohols using gas stripping and membrane processes. *AIChE Symposium Series* 90(300):63–79 (1994).
- 40 Qureshi N and Blaschek HP, Recovery of butanol from fermentation broth by gas stripping. *Renewable Energy* 22:557–564 (2001).
- 41 Taylor F, Kurantz MJ, Goldberg N, McAloon AJ and Craig JC, Jr, Dry-grind process for fuel ethanol by continuous fermentation and stripping. *Biotechnol Prog* 16:541–547 (2000).
- 42 Dominguez JM, Cao N, Gong CS and Tsao GT, Ethanol production from xylose with the yeast *Pichia stipitis* and simultaneous product recovery by gas stripping using a gas-lift loop fermentor with attached side-arm (CLSA). *Biotech Bioeng* 67:336–343 (2000).
- 43 Ezeji TC, Qureshi N and Blaschek HP, Acetone butanol ethanol (ABE) production from concentrated substrate: reduction in substrate inhibition by fed-batch technique and product inhibition by gas stripping. *Appl Microbiol Biotechnol* 63:653–658 (2004).
- 44 Roffler SR, Blanch HW and Wilke CR, In-situ recovery of butanol during fermentation. Part 1: Batch extractive fermentation. *Bioproc Eng* 2:1–12 (1987).
- 45 Bothun GD, Knutson BL, Strobel HJ, Nokes SE, Brignole EA and Diaz S, Compressed solvents for the extraction of fermentation products within a hollow fiber membrane contactor. *J Supercritical Fluids* 25:119–134 (2002).
- 46 Costa AC, Atala DIP, Maugeri F and Maciel R, Factorial design and simulation for the optimization and determination of control structures for an extractive alcoholic fermentation. *Proc Biochem* 37:125–137 (2001).
- 47 Ramalingham A and Finn RK, The Vacuform process: a new approach to fermentation alcohol. *Biotech Bioeng* 19:583–589 (1977).
- 48 Cysewski GR and Wilke CR, Process design and economic studies of alternative fermentation methods for the production of ethanol. *Biotech Bioeng* 20:1421–1444 (1978).
- 49 Costa AC, Dechechi EC, Silva FLH, Maugeri F and Maciel R, Simulated dynamics and control of an extractive alcoholic fermentation. *Appl Biochem Biotechnol* 84–86:577–593 (2000).
- 50 Silva FLH, Rodrigues MI and Maugeri F, Dynamic modelling, simulation and optimization of an extractive continuous alcoholic fermentation process. *J Chem Technol Biotechnol* 74:176–182 (1999).
- 51 Wright AJ and Pyle DL, An investigation into the use of the spinning cone column for *in situ* ethanol removal from a yeast broth. *Proc Biochem* 31:651–658 (1996).
- 52 Udriot H, Ampuero S, Marison IW and von Stockar U, Extractive fermentation of ethanol using membrane distillation. *Biotechnol Lett* 11:509–514 (1989).
- 53 Garcia-Payo MC, Izquierdo-Gil MA and Fernandez-Pineda C, Air gap membrane distillation of aqueous alcohol solutions. *J Membr Sci* 169:61–80 (2000).
- 54 Kaseno, Miyazawa I and Kokugan T, Effect of product removal by a pervaporation on ethanol fermentation. *J Ferment Bioeng* 86:488–493 (1998).
- 55 Izquierdo-Gil MA and Jonsson G, Factors affecting flux and ethanol separation performance in vacuum membrane distillation (VMD). *J Membr Sci* 214:113–130 (2003).
- 56 Wei Z, Xingju Y and Quan Y, Ethanol fermentation coupled with complete cell recycle pervaporation system: dependence of glucose concentration. *Biotechnol Tech* 9:299–304 (1995).
- 57 Qureshi N, Meagher MM and Hutkins RW, Recovery of butanol from model solutions and fermentation broth using silicalite/silicone membrane. *J Membr Sci* 158:115–125 (1999).
- 58 Qureshi N and Blaschek HP, Butanol recovery from model solution/fermentation broth by pervaporation: evaluation of membrane performance. *Biomass and Bioenergy* 17:175–184 (1999).
- 59 Qureshi N and Blaschek HP, Production of acetone butanol ethanol (ABE) by a hyper-producing mutant strain of *Clostridium beijerinckii* BA101 and recovery by pervaporation. *Biotechnol Prog* 15:594–602 (1999).
- 60 Ikegami T, Yanagishita H, Kitamoto D, Haraya K, Nakane T, Matsuda H, Koura N and Sano T, Production of highly concentrated ethanol in a coupled fermentation/pervaporation process using silicalite membranes. *Biotechnol Tech* 11:921–924 (1997).
- 61 O'Brien DJ and Craig JC, Jr, Ethanol production in a continuous fermentation/membrane pervaporation system. *Appl Microbiol Biotechnol* 44:699–704 (1996).
- 62 Matsumura M, Takehara S and Kataoka H, Continuous butanol/isopropanol fermentation in down-flow column

- reactor coupled with pervaporation using supported liquid membrane. *Biotech Bioeng* **39**:148–156 (1992).
- 63 Larrayoz MA and Puigianer L, Study of butanol extraction through pervaporation in acetobutylic fermentation. *Biotech Bioeng* **30**:692–696 (1987).
 - 64 Hickey PJ and Slater CS, The selective recovery of alcohols from fermentation broths by pervaporation. *Sep Purif Methods* **19**:93–115 (1990).
 - 65 Gudernatsch W, Kimmerle K, Stroh N and Chmiel H, Recovery and concentration of high vapour pressure bioproducts by means of controlled membrane separation. *J Membr Sci* **36**:331–342 (1988).
 - 66 Ikegami T, Yanagishita H, Kitamoto D, Haraya K, Nakane T, Matsuda H, Koura N and Sano T, Highly concentrated aqueous ethanol solutions by pervaporation using silicalite membrane—improvement of ethanol selectivity by addition of sugars to ethanol solution. *Biotechnol Lett* **21**:1037–1041 (1999).
 - 67 Groot WJ, van der Oever CE and Kossen NWF, Pervaporation for simultaneous product recovery in the butanol/isopropanol batch fermentation. *Biotechnol Lett* **6**:709–714 (1984).
 - 68 Fadeev AG, Meagher MM, Kelley SS and Volkov VV, Fouling of poly[1-(trimethylsilyl)-1-propyne] membranes in pervaporative recovery of butanol from aqueous solutions and ABE fermentation broth. *J Membr Sci* **173**:133–144 (2000).
 - 69 Mulder MHV and Smolders CA, Continuous ethanol production controlled by membrane processes. *Proc Biochem* **21**:35–39 (1986).
 - 70 Geng Q and Park C-H, Pervaporative butanol fermentation by *Clostridium acetobutylicum* B18. *Biotech Bioeng* **43**:978–986 (1994).
 - 71 Mori Y and Inaba T, Ethanol production from starch in a pervaporation membrane bioreactor using *Clostridium thermohydrosulfuricum*. *Biotech Bioeng* **36**:849–853 (1990).
 - 72 Shabtai Y, Chaimovitz S, Freeman A, Katchalski-Katzir E, Linder C, Nemas M, Perry M and Kedem O, Continuous ethanol production by immobilized yeast reactor coupled with membrane pervaporation unit. *Biotech Bioeng* **38**:869–876 (1991).
 - 73 Strathmann H and Gudernatsch W, Continuous removal of ethanol from fermentation broths by pervaporation, in *Separations for Biotechnology*, ed by Verrall MS and Hudson MJ. Ellis Horwood Limited, Chichester, pp 353–359 (1987).
 - 74 Cho W-C and Hwang S-T, Continuous membrane fermentor separator for ethanol fermentation. *J Membr Sci* **57**:21–42 (1991).
 - 75 Groot WJ, Kraayenbrink MR, Waldram RH, van der Lans RGJM and Luyben KChAM, Ethanol production in an integrated process of fermentation and ethanol recovery by pervaporation. *Bioproc Eng* **8**:99–111 (1992).
 - 76 Strathmann H and Gudernatsch W, Continuous removal of ethanol from bioreactor by pervaporation, in *Extractive Bioconversions*, ed by Mattiasson B and Holst O. Marcel Dekker, New York, pp 67–89 (1991).
 - 77 Shabtai Y and Mandel C, Control of ethanol production and monitoring of membrane performance by mass-spectrometric gas analysis in the coupled fermentation–pervaporation of whey permeate. *Appl Microbiol Biotechnol* **40**:470–476 (1993).
 - 78 Qureshi N and Maddox IS, Application of novel technology to the ABE fermentation process: an economic analysis. *Appl Biochem Biotechnol* **34/35**:441–448 (1992).
 - 79 Nakao S-I, Saitoh F, Asakura T, Toda K and Kimura S, Continuous ethanol extraction by pervaporation from a membrane bioreactor. *J Membr Sci* **30**:273–287 (1987).
 - 80 Schmidt SL, Myers MD, Kelley SS, McMillan JD and Padukone N, Evaluation of PTMSP membranes in achieving enhanced ethanol removal from fermentations by pervaporation. *Appl Biochem Biotechnol* **63–65**:469–482 (1997).
 - 81 Groot WJ, Kraayenbrink MR, van der Lans RGJM and Luyben KChAM, Ethanol production in an integrated fermentation/membrane system. Process simulations and economics. *Bioproc Eng* **8**:189–201 (1993).
 - 82 Qureshi N, Meagher MM, Huang J and Hutkins RW, Acetone butanol ethanol (ABE) recovery by pervaporation using silicalite–silicone composite membrane from fed-batch reactor of *Clostridium acetobutylicum*. *J Membr Sci* **187**:93–102 (2001).
 - 83 Huang J and Meagher MM, Pervaporative recovery of *n*-butanol from aqueous solutions and ABE fermentation broth using thin-film silicalite-filled silicone composite membranes. *J Membr Sci* **192**:231–242 (2001).
 - 84 Ikegami T, Yanagishita H, Kitamoto D, Negishi H, Haraya K and Sano T, Concentration of fermented ethanol by pervaporation using silicalite membranes coated with silicone rubber. *Desalination* **149**:49–54 (2002).
 - 85 Fadeev AG, Kelley SS, McMillan JD, Selinskaya YaA, Khotimsky VS and Volkov VV, Effect of yeast fermentation by-products on poly(1-trimethylsilyl-1-propyne) pervaporative performance. *J Membr Sci* **214**:229–238 (2003).
 - 86 O'Brien DJ, Senske GE, Kurantz MJ and Craig JC, Jr, Ethanol recovery from corn fiber hydrolysate fermentations by pervaporation. *Bioresource Technology* **92**:15–19 (2004).
 - 87 Nomura M, Bin T and Nakao S-I, Selective ethanol extraction from fermentation broth using a silicalite membrane. *Sep Purif Technol* **27**:59–66 (2002).
 - 88 Ikegami T, Kitamoto D, Negishi H, Haraya K, Matsuda H, Nitani Y, Koura N, Sano T and Yanagishita H, Drastic improvement of bioethanol recovery using a pervaporation separation technique employing a silicone rubber-coated silicalite membrane. *J Chem Technol Biotechnol* **78**:1006–1010 (2003).
 - 89 Hausmanns S, Lipnizki F, Laufenberg G, Field RW and Kunz B, Potential contribution of hydrophobic pervaporation to the realization of clean production, in *Proceedings of the 2nd Asia Pacific Roundtable on Cleaner Production, 21–23 April 1999, Brisbane, Australia*, ed by Scott JA and Pagan RJ. Australian Cleaner Production Association Inc, Brisbane, Australia, pp 625–634 (1999).
 - 90 Jonquieres A, Clement R, Lochon P, Neel J, Dresch M and Chretien B, Industrial state-of-the-art of pervaporation and vapour permeation in the western countries. *J Membr Sci* **206**:87–117 (2002).
 - 91 ASTM International, Standard specification for denatured fuel ethanol for blending with gasoline for use as automotive spark ignition engine fuel. **D4806** 2004.
 - 92 Reynolds RE, Fuel specifications and fuel property issues and their potential impact on the use of ethanol as a transportation fuel. Subcontract No 4500010570. Downstream Alternatives, Inc Report prepared for Oak Ridge National Laboratory Ethanol Project (2002).
 - 93 Qureshi N, Maddox IS and Friedl A, Application of continuous substrate feeding to the ABE fermentation: relief of product inhibition using extraction, perstraction, stripping and pervaporation. *Biotechnol Prog* **8**:382–390 (1992).
 - 94 Kawedia Jitesh D, Pangarkar VG and Niranjana K, Pervaporative stripping of acetone, butanol and ethanol to improve ABE fermentation. *Bioseparation* **9**:145–154 (2000).
 - 95 Gagne I, Matsuura T and Duvnjak Z, Enhanced high fructose syrup production by a hybrid fermentation/pervaporation system using a silicone rubber hollow fiber membrane module. *Sep Sci Technol* **37**:2055–2075 (2002).
 - 96 Roca C and Olsson L, Increasing ethanol productivity during xylose fermentation by cell recycling of recombinant *Saccharomyces cerevisiae*. *Appl Microbiol Biotechnol* **60**:560–563 (2003).
 - 97 Friedl A, Qureshi N and Maddox IS, Continuous acetone–butanol–ethanol (ABE) fermentation using immobilized cells of *Clostridium acetobutylicum* in a packed bed reactor and integration with product removal by pervaporation. *Biotech Bioeng* **38**:518–527 (1991).
 - 98 Groot WJ and Luyben KChAM, Continuous production of butanol from a glucose/xylose mixture with an immobilized

- cell system coupled to pervaporation. *Biotechnol Lett* **9**:867–870 (1987).
- 99 Groot WJ, den Reyer MCH, Baart de la Faille T, van der Lans RGJM and Luyben KChAM, Integration of pervaporation and continuous butanol fermentation with immobilized cells. I: Experimental results. *Chem Eng J* **46**:B1–B10 (1991).
 - 100 Groot WJ, den Reyer MCH, van der Lans RGJM and Luyben KChAM, Integration of pervaporation and continuous butanol fermentation with immobilized cells. II: Mathematical modelling and simulations. *Chem Eng J* **46**:B11–B19 (1991).
 - 101 Groot WJ, Schoutens GH, van Beelen PN, van den Oever CE and Kossen NWF, Increase of substrate conversion by pervaporation in the continuous butanol fermentation. *Biotechnol Lett* **6**:789–792 (1984).
 - 102 Yamada T, Fatigati MA and Zhang M, Performance of immobilized *Zymomonas mobilis* 31821 (pZB5) on actual hydrolysates produced by Arkenol technology. *Appl Biochem Biotechnol* **98–100**:899–907 (2002).
 - 103 Vega JL, Clausen EC and Gaddy JL, Biofilm reactors for ethanol production. *Enzyme Microb Technol* **10**:390–402 (1988).
 - 104 Amin G and Doelle HW, Production of high ethanol concentrations from glucose using *Zymomonas mobilis* entrapped in a vertical rotating immobilized cell reactor. *Enzyme Microb Technol* **12**:443–446 (1990).
 - 105 Zacchi G and Axelsson A, Economic evaluation of preconcentration in production of ethanol from dilute sugar solutions. *Biotech Bioeng* **34**:223–233 (1989).
 - 106 Hansen NL, From filter presses over centrifuges to cross flow and vibrating membrane filtration: a review of recovery of beer from surplus yeast. *MBAA TQ* **38**:115–121 (2001).
 - 107 Chang HN, Yoo I-K and Kim BS, High density cell culture by membrane-based cell recycle. *Biotechnology Advances* **12**:467–487 (1994).
 - 108 Rose P, Separation solutions for the global brewing industry. *Filtration + Separation* **2003**:20–23 (2003).
 - 109 Ma W, Sun Z, Wang Z, Feng YB, Wang TC, Chan US, Miu CH and Zhu S, Application of membrane technology for drinking water. *Desalination* **119**:127–131 (1998).
 - 110 Hsu B-M and Yeh H-H, Removal of *Giardia* and *Cryptosporidium* in drinking water treatment: a pilot-scale study. *Water Res* **37**:1111–1117 (2003).
 - 111 Madaeni SS, The application of membrane technology for water disinfection. *Water Res* **33**:301–308 (1999).
 - 112 Jacangelo JG, Trussell RR and Watson M, Role of membrane technology in drinking water treatment in the United States. *Desalination* **113**:119–127 (1997).
 - 113 US Environmental Protection Agency, Membrane filtration guidance manual (proposal draft). EPA 815-D-03-008 (2003).
 - 114 Knutsen JS and Davis RH, Combined sedimentation and filtration process for cellulase recovery during hydrolysis of lignocellulosic biomass. *Appl Biochem Biotechnol* **98–100**:1161–1172 (2002).
 - 115 Krishnan MS, Taylor F, Davison BH and Nghiem NP, Economic analysis of fuel ethanol production from corn starch using fluidized-bed bioreactors. *Bioresource Technology* **75**:99–105 (2000).
 - 116 Nguyen MH, Alternatives to spray irrigation of starch waste based distillery effluent. *Journal of Food Engineering* **60**:367–374 (2003).
 - 117 Matson SL, Membrane bioseparations, in *Membrane Separations Technology: Principles and Applications*, ed by Noble RD and Stern SA. *Membrane Science and Technology Series*, Elsevier BV, Amsterdam, pp 353–414 (1995).
 - 118 Cheryan M and Alvarez JR, Food and beverage industry applications, in *Membrane Separations Technology: Principles and Applications*, ed by Noble RD and Stern SA. *Membrane Science and Technology Series*, Elsevier Science BV, Amsterdam, pp 415–466 (1995).
 - 119 Galbe M, Pilcher L and Roslander C, Separation of solid residues after SSF and SHF in fuel ethanol production from spruce. Poster presentation at 24th Symposium on Biotechnology for Fuels and Chemicals, Gatlinburg TN, April 28–May (2002).
 - 120 Maybury JP, Hoare M and Dunnill P, The use of laboratory centrifugation studies to predict performance of industrial machines: studies of shear-insensitive and shear-sensitive materials. *Biotech Bioeng* **67**:265–273 (2000).
 - 121 Yuan H, Rickwood D, Smyth IC and Thew MT, An investigation into the possible use of hydrocyclones for the removal of yeast from beer. *Bioseparation* **6**:159–163 (1996).
 - 122 Kaseno and Kokugan T, The effect of molasses pretreatment by ceramic microfiltration membrane on ethanol fermentation. *J Ferment Bioeng* **83**:577–582 (1997).
 - 123 Mercier M, Maranges C, Fonade C and Lafforgue-Delorme C, Yeast suspension filtration: flux enhancement using an upward gas/liquid slug flow—application to continuous alcoholic fermentation with cell recycle. *Biotech Bioeng* **58**:47–57 (1998).
 - 124 Al-Akoum O, Jaffrin MY, Ding L, Paullier P and Vanhoutte C, An hydrodynamic investigation of microfiltration and ultrafiltration in a vibrating membrane module. *J Membr Sci* **197**:37–52 (2002).
 - 125 Harscoat C, Jaffrin MY, Bouzerar R and Courtois J, Influence of fermentation conditions and microfiltration processes on membrane fouling during recovery of glucuronane polysaccharides from fermentation broths. *Biotech Bioeng* **65**:500–511 (1999).
 - 126 Frenander U and Jonsson A-F, Cell harvesting by cross-flow microfiltration using a shear-enhanced module. *Biotech Bioeng* **52**:397–403 (1996).
 - 127 Lee SS, Burt A, Russotti G and Buckland B, Microfiltration of recombinant yeast cells using a rotating disk dynamic filtration system. *Biotech Bioeng* **48**:386–400 (1995).
 - 128 Atala DIP, Costa AC, Maciel R and Maugeri F, Kinetics of ethanol fermentation with high biomass concentration considering the effect of temperature. *Appl Biochem Biotechnol* **91–93**:353–365 (2001).
 - 129 Nguyen QA, Keller FA, Tucker MP, Lombard CK, Jenkins BM, Yomogida DE and Tiangco BM, Bioconversion of mixed solids waste to ethanol. *Appl Biochem Biotechnol* **77–79**:455–472 (1999).
 - 130 Postlethwaite J, Lamping SR, Leach GC, Hurwitz MF and Lye GJ, Flux and transmission characteristics of a vibrating microfiltration system operated at high biomass loading. *J Membr Sci* **228**:89–101 (2004).
 - 131 Negro MJ, Manzanares P, Ballesteros I, Oliva JM, Cabanas A and Ballesteros M, Hydrothermal pretreatment conditions to enhance ethanol production from poplar biomass. *Appl Biochem Biotechnol* **105–108**:87–100 (2003).
 - 132 Jaffrin MY, Ding L-H, Akoum O and Brou A, A hydrodynamic comparison between rotating disk and vibratory dynamic filtration systems. *J Membr Sci* **242**:155–167 (2004).
 - 133 Schwinge J, Neal PR, Wiley DE, Fletcher DF and Fane AG, Spiral wound modules and spacers: review and analysis. *J Membr Sci* **242**:129–153 (2004).xg
 - 134 Ghaly AE and Kamal MA, Submerged yeast fermentation of acid cheese whey for protein production and pollution potential reduction. *Water Res* **38**:631–644 (2004).
 - 135 Li F, Meindersma GW, de Haan AB and Reith T, Optimization of commercial net spacers in spiral wound membrane modules. *J Membr Sci* **208**:289–302 (2002).
 - 136 Krstic DM, Tekic MN, Caric MD and Milanovic SD, The effect of turbulence promoter on cross-flow microfiltration of skim milk. *J Membr Sci* **208**:303–314 (2002).
 - 137 Mores WD and Davis RH, Yeast foulant removal by backpulses in crossflow microfiltration. *J Membr Sci* **208**:389–404 (2002).
 - 138 Eykamp W, Microfiltration and ultrafiltration, in *Membrane Separations Technology: Principles and Applications*, ed by

- Noble RD and Stern SA. *Membrane Science and Technology Series*, Elsevier Science BV, Amsterdam, pp 1–43 (1995).
- 139 Mulder MHV, Polarization phenomena and membrane fouling, in *Membrane Separations Technology: Principles and Applications*, ed by Noble RD and Stern SA. *Membrane Science and Technology Series*, Elsevier Science BV, Amsterdam, pp 45–84 (1995).
- 140 Al-Akoum O, Mercier-Bonin M, Ding L, Fonade C, Aptel P and Jaffrin MY, Comparison of three different systems used for flux enhancement: application to crossflow filtration of yeast suspensions. *Desalination* **147**:31–36 (2002).
- 141 Akoum O, Jaffrin MY and Ding L-H, Concentration of total milk proteins by high shear ultrafiltration in a vibrating membrane module. *J Membr Sci* **247**:211–220 (2005).
- 142 Shaban HI, Riazi MR and Sahar R, Pervaporation of alcohols from hydrocarbon mixtures. *Sep Purif Technol* **11**:113–118 (1997).
- 143 Baudot A and Marin M, Dairy aroma compounds recovery by pervaporation. *J Membr Sci* **120**:207–220 (1996).
- 144 Cen Y and Lichtenthaler RN, Vapor permeation, in *Membrane Separations Technology: Principles and Applications*, ed by Noble RD and Stern SA. *Membrane Science and Technology Series*, Elsevier Science BV, Amsterdam, pp 85–112 (1995).
- 145 Vane LM, Alvarez FR and Giroux EL, Reduction of concentration polarization in pervaporation using vibrating membrane module. *J Membr Sci* **153**:233–241 (1999).
- 146 Vane LM, Hitchens L, Alvarez FR and Giroux EL, Field demonstration of pervaporation for the separation of volatile organic compounds from a surfactant-based soil remediation fluid. *J Hazard Mater* **81**:141–166 (2001).
- 147 Vane LM, Alvarez FR and Mullins B, Removal of methyl *t*-butyl ether (MTBE) from water by pervaporation: bench-scale and pilot-scale evaluations. *Environ Sci Technol* **35**:391–397 (2001).
- 148 Vane LM and Alvarez FR, Full-scale vibrating pervaporation membrane unit: VOC removal from water and surfactant solutions. *J Membr Sci* **202**:177–193 (2002).
- 149 Kondo M, Komori M, Kita H and Okamoto K, Tubular-type pervaporation module with zeolite NaA membrane. *J Membr Sci* **133**:133–141 (1997).
- 150 Oliveira TAC, Cocchini U, Scarpello JT and Livingston AG, Pervaporation mass transfer with liquid flow in the transition regime. *J Membr Sci* **183**:119–133 (2001).
- 151 Morigami Y, Kondo M, Abe J, Kita H and Okamoto K, The first large-scale pervaporation plant using tubular-type module with zeolite NaA membrane. *Sep Purif Technol* **25**:251–260 (2001).
- 152 Urtiaga A, Gorri ED, Casado C and Ortiz I, Pervaporative dehydration of industrial solvents using a zeolite NaA commercial membrane. *Sep Purif Technol* **32**:207–213 (2003).
- 153 Kalipcilar H, Gade SK, Noble RD and Falconer JL, Synthesis and separation properties of B-ZSM-5 zeolite membranes on monolith supports. *J Membr Sci* **210**:113–127 (2002).
- 154 High-performance, low-cost pervaporation modules for ethanol extraction. Abstract of 2003 DOE Phase I SBIR grant (2003).
- 155 LaMonica D, Application of a unique module design for wastewater treatment. Abstract from presentation at 2004 North American Membrane Society annual meeting, Honolulu HI USA (2004).
- 156 Moniruzzaman M, York SW and Ingram LO, Effects of process errors on the production of ethanol by *Escherichia coli* KO11. *J Ind Microbiol Biotechnol* **20**:281–286 (1998).
- 157 Lewis JG, Learmonth RP and Watson K, Induction of heat, freezing and salt tolerance by heat and salt shock in *Saccharomyces cerevisiae*. *Microbiology* **141**:687–694 (1995).
- 158 Piper PW, The yeast heat shock response, in *Yeast Stress Responses*, ed by Hohmann S and Mager WH. RG Landes Co, Austin, pp 75–99 (1997).
- 159 van Uden N, Effects of ethanol on the temperature relations of viability and growth in yeast. *Crit Rev Biotechnol* **1**:263–272 (1984).
- 160 van Uden N, Temperature profiles of yeasts. *Adv Microb Physiol* **25**:195–251 (1984).
- 161 van Uden N and da Cruz Duarte H, Effects of ethanol on the temperature profile of *Saccharomyces cerevisiae*. *Zeitschrift für Allgemeine Mikrobiologie* **21**:743–750 (1981).
- 162 Lucas JL and Martin FE, Process for production of lignin fuel, ethyl alcohol, cellulose, silica/silicates, and cellulose derivatives from plant biomass. US Patent 5,735,916 (1998).
- 163 Golias H, Dumsday GJ, Stanley GA and Pamment NB, Evaluation of a recombinant *Klebsiella oxytoca* strain for ethanol production from cellulose by simultaneous saccharification and fermentation: comparison with native cellobiose-utilising yeast strains and performance in co-culture with thermotolerant yeast and *Zymomonas mobilis*. *J Biotechnol* **96**:155–168 (2002).
- 164 Kashiwagi T, Okabe K and Okita K, Separation of ethanol from ethanol/water mixtures by plasma-polymerized membranes from silicone compounds. *J Membr Sci* **36**:353–362 (1988).
- 165 Masuda T, Isobe E and Higashimura T, Poly[1-(trimethylsilyl)-1-propyne]: a new high polymer synthesized with transition-metal catalysts and characterized by extremely high gas permeability. *J Am Chem Soc* **105**:7473–7474 (1983).
- 166 Pinnau I and Toy LG, Transport of organic vapors through poly(1-trimethylsilyl-1-propyne). *J Membr Sci* **116**:199–209 (1996).
- 167 Volkov VV, Khotimsky VS, Litvinova EG, Fadeev AG, Selinskaya YaA, Plate NA, McMillan JD and Kelley SS, Development of novel poly[1-(trimethylsilyl)-1-propyne] based materials for pervaporation separation in biofuel production. *Polym Mater Sci Eng* **77**:339–340 (1997).
- 168 Ichiraku Y, Stern SA and Nakagawa T, An investigation of the high gas permeability of poly(1-trimethylsilyl-1-propyne). *J Membr Sci* **34**:5–18 (1987).
- 169 Volkov VV, Fadeev AG, Khotimsky VS, Litvinova EG, Selinskaya YaA, McMillan JD and Kelley SS, Effects of synthesis conditions on the pervaporation properties of poly[1-(trimethylsilyl)-1-propyne] useful for membrane bioreactors. *J Appl Polym Sci* **91**:2271–2277 (2004).
- 170 Fadeev AG, Selinskaya YaA, Kelley SS, Meagher MM, Litvinova EG, Khotimsky VS and Volkov VV, Extraction of butanol from aqueous solutions by pervaporation through poly(1-trimethylsilyl-1-propyne). *J Membr Sci* **186**:205–217 (2001).
- 171 Ruud CJ, Jia J and Baker GL, Synthesis and characterization of poly[(1-trimethylsilyl-1-propyne)-*co*-(1-(4-azidobutyl)dimethylsilyl)-1-propyne] copolymers. *Macromolecules* **33**(8184–8191):(2000).
- 172 Jia J and Baker GL, Cross-linking of poly(1-trimethylsilyl-1-propyne) membranes using bis(aryl azides). *J Appl Polym Sci: Part B: Polymer Physics* **36**:959–968 (1998).
- 173 Bowen TC, Noble RD and Falconer JL, Review: fundamentals and applications of pervaporation through zeolite membranes. *J Membr Sci* **245**:1–33 (2004).
- 174 Vankelecom IFJ, Scheppers E, Heus R and Uytterhoeven JB, Parameters influencing zeolite incorporation in PDMS membranes. *J Phys Chem* **98**:12 390–12 396 (1994).
- 175 Meagher MM, Qureshi N and Hutkins RW, Silicalite membrane and method for the selective recovery and concentration of acetone and butanol from model ABE solutions and fermentation broth. US Patent 5,755,967 (1998).
- 176 Matsuda H, Yanagishita H, Negishi H, Kitamoto D, Ikegami T, Haraya K, Nakane K, Idemoto Y, Koura N and Sano T, Improvement of ethanol selectivity of silicalite membrane in pervaporation by silicone rubber coating. *J Membr Sci* **210**:433–437 (2002).
- 177 Aminabhavi TM, Khinnavar SB, Harogoppad SB, Aithal US, Nguyen QT and Hansen KC, Pervaporation separation of organic–aqueous and organic–organic binary mixtures. *Journal of Macromolecular Science Rev Macromol Chem Phys* **C34**:139–204 (1994).

- 178 Dutta BK, Ji W and Sikdar SK, Pervaporation: principles and applications. *Sep Purif Methods* **25**:131–224 (1996).
- 179 Karlsson HOE and Tragardh G, Pervaporation of dilute organic–water mixtures. A literature review on modelling studies and applications to aroma compound recovery. *J Membr Sci* **76**:121–146 (1993).
- 180 Zhang S and Drioli E, Pervaporation membranes. *Sep Sci Technol* **30**:1–31 (1995).
- 181 Blume I, Wijmans JG and Baker RW, The separation of dissolved organics from water by pervaporation. *J Membr Sci* **49**:253–286 (1990).
- 182 Lawson KW and Lloyd DR, Membrane distillation. I. Module design and performance evaluation using vacuum membrane distillation. *J Membr Sci* **120**:111–121 (1996).
- 183 Gostoli C, Sarti GC and Bandini S, Membrane distillation of ethanol–water mixtures, in *Separations for Biotechnology*, ed by Verrall MS and Hudson MJ. Ellis Horwood Limited, Chichester, pp 383–394 (1987).
- 184 Vrana DL, Meagher MM, Hutkins RW and Duffield B, Pervaporation of model acetone–butanol–ethanol fermentation product solutions using polytetrafluoroethylene membranes. *Sep Sci Technol* **28**:2167–2178 (1993).
- 185 Ghofar A and Kokugan T, The pervaporation mechanism of dilute ethanol solution by hydrophobic porous membranes. *Biochem Eng J* **18**:235–238 (2004).
- 186 Sano T, Ejiri S, Yamada K, Kawakami Y and Yanagishita H, Separation of acetic acid–water mixtures by pervaporation through silicalite membrane. *J Membr Sci* **123**:225–233 (1997).
- 187 Aroujalian A, Belkacemi K, Davids SJ, Turcotte G and Pouliot Y, Effect of protein on flux and selectivity in pervaporation of ethanol from dilute solution. *Sep Sci Technol* **38**:3239–3247 (2003).
- 188 Qureshi N and Blaschek HP, Fouling studies of a pervaporation membrane with commercial fermentation media and fermentation broth of hyper-butanol-producing *Clostridium beijerinckii* BA101. *Sep Sci Technol* **34**:2803–2815 (1999).
- 189 Lipnizki F, Hausmanns S and Field RW, Influence of impermeable components on the permeation of aqueous 1-propanol mixtures in hydrophobic pervaporation. *J Membr Sci* **228**:129–138 (2004).
- 190 Nakano K, Shimoda M, Uemura Y and Hatate Y, Influence of organic acid salts, glycerin and sugars on ethanol and minor alcohols vapor-liquid equilibrium ratios in ethanol aqueous solution. *J Chem Eng Japan* **30**:1144–1146 (1997).
- 191 Vigneswaran S and Mora JC, Energy recovery considerations for membrane separation process. *RERIC International Energy Journal* **11**:1–15 (1989).
- 192 Sobocan G and Glavic P, Optimization of ethanol fermentation process design. *Applied Thermal Engineering* **20**:529–543 (2000).
- 193 EPRI Process Industry Coordination Office, Industrial heat pumps. *TechCommentary* 1. Battelle Memorial Institute, Columbus, OH (1998).
- 194 Industrial heat pumps for steam and fuel savings. DOE/GO-102003-1735. Best Practices Steam Technical Brief, US Department of Energy, Washington, DC, USA (2003).
- 195 International Energy Agency, Heat Pump Centre, web site: <http://www.heatpumpcentre.org/> (2004) [accessed 15 August 2004].
- 196 Wallin E, Franck PA and Berntsson T, Heat pumps in industrial processes—an optimization methodology. *Heat Recovery Systems & CHP* **10**:437–446 (1990).
- 197 McMullan A, Industrial heat pumps for steam and fuel savings. DOE/GO-102003-1735. Best Practices Steam Technical Brief, US Department of Energy, Washington, DC, USA (2003).
- 198 Hewitt NJ, McMullan JT, Henderson PC and Mongey B, Advanced cycles and replacement working fluids in heat pumps. *Applied Thermal Engineering* **21**:237–248 (2001).
- 199 Feng X and Berntsson T, Critical COP for an economically feasible industrial heat-pump application. *Applied Thermal Engineering* **17**:93–101 (1997).
- 200 Vane LM, Alvarez FR, Mairal AP and Baker RW, Separation of vapor-phase alcohol/water mixtures via fractional condensation using a pilot-scale dephlegmator: enhancement of the pervaporation process separation factor. *Ind Eng Chem Res* **43**:173–183 (2004).
- 201 Vane LM, Mairal AP, Ng A, Alvarez FR and Baker RW, Separation process using pervaporation and dephlegmation. US Patent 6,755,975 (2004).
- 202 Madson PW and Lococo DB, Recovery of volatile products from dilute high-fouling process streams. *Appl Biochem Biotechnol* **84–86**:1049–1061 (2000).
- 203 Brush BF and Katzen R, Hydrous alcohol distillation method and apparatus. Raphael Katzen Associates International Inc. US Patent 4,306,942 (1981).
- 204 Blume I and Baker RW, Process for recovering organic components from liquid streams. Membrane Technology & Research, Inc. US Patent 5,030,356 (1991).
- 205 Matsumura M, Kataoka H, Sueki M and Araki K, Energy saving effect of pervaporation using oleyl alcohol liquid membrane in butanol purification. *Bioproc Eng* **3**:93–100 (1998).
- 206 Field RW and Lobo V, Hydrophobic pervaporation: toward a shortcut method for the pervaporation–decanter system. *Ann NY Acad Sci* **984**:401–410 (2003).
- 207 Baker RW, Athayde AL, Daniels R, Le M, Pinnau I, Ly JH, Wijmans JG, Kaschemekat JH and Helm VD, Development of pervaporation to recover and reuse volatile organic compounds from industrial waste Streams. DOE/AL/98769–1. Report to US Department of Energy (1997).
- 208 O'Brien DJ, Roth LH and McAloon AJ, Ethanol production by continuous fermentation–pervaporation: a preliminary economic analysis. *J Membr Sci* **166**:105–111 (2000).
- 209 Di Luccio M, Borges CP and Alves TLM, Economic analysis of ethanol and fructose production by selective fermentation coupled to pervaporation: effect of membrane costs on process economics. *Desalination* **147**:161–166 (2002).
- 210 Ishihara K and Matsui K, Pervaporation of ethanol–water mixture through composite membranes composed of styrene–fluoroalkyl acrylate graft copolymers and cross-linked polydimethylsiloxane membrane. *J Appl Polym Sci* **34**:437–440 (1987).
- 211 Slater CS, Hickey PJ and Juricic FP, Pervaporation of aqueous ethanol mixtures through poly(dimethyl siloxane) membranes. *Sep Sci Technol* **25**:1063–1077 (1990).
- 212 Moermans B, De Beuckelaer W, Vankelecom IFJ, Ravishankar R, Martens JA and Jacobs PA, Incorporation of nano-sized zeolites in membranes. *Chem Commun* 2467–2468 (2000).
- 213 Takegami S, Yamada H and Tsujii S, Pervaporation of ethanol/water mixtures using novel hydrophobic membranes containing polydimethylsiloxane. *J Membr Sci* **75**:93–105 (1992).
- 214 te Hennepe HJC, Bargeman D, Mulder MHV and Smolders CA, Zeolite-filled silicone rubber membranes. Part I. Membrane preparation and pervaporation results. *J Membr Sci* **35**:39–55 (1987).
- 215 Jia M-D, Peinemann K-V and Behling R-D, Preparation and characterization of thin-film zeolite–PDMS composite membranes. *J Membr Sci* **73**:119–128 (1992).
- 216 Chen X, Ping ZH and Long YC, Separation properties of alcohol–water mixture through silicalite-I-filled silicone rubber membranes by pervaporation. *J Appl Polym Sci* **67**:629–636 (1998).
- 217 Vankelecom IFJ, Depre D, De Beukelaer S and Uytterhoeven JB, Influence of zeolites in PDMS membranes: pervaporation of water/alcohol mixtures. *J Phys Chem* **99**:13 193–13 197 (1995).
- 218 Vankelecom IFJ, De Beukelaer S and Uytterhoeven JB, Sorption and pervaporation of aroma compounds using zeolite-filled PDMS membranes. *J Phys Chem B* **101**:5186–5190 (1997).
- 219 Boddeker KW, Bengtson G and Pingel H, Pervaporation of isomeric butanols. *J Membr Sci* **54**:1–12 (1990).

- 220 Kujawski W, Pervaporative removal of organics from water using hydrophobic membranes: binary mixtures. *Sep Sci Technol* **35**:89–108 (2000).
- 221 Nagase Y, Takamura Y and Matsui K, Chemical modification of poly(substituted-acetylene): V. Alkylsilylation of poly(1-trimethylsilyl-1-propyne) and improved liquid separating property at pervaporation. *J Appl Polym Sci* **42**:185–190 (1991).
- 222 Hickey PJ, Juricic FP and Slater CS, The effect of process parameters on the pervaporation of alcohols through organophilic membranes. *Sep Sci Technol* **27**:843–861 (1992).
- 223 Gonzalez-Velasco JR, Gonzalez-Marcos JA and Lopez-Dehesa C, Pervaporation of ethanol–water mixtures through poly(1-trimethylsilyl-1-propyne) (PTMSP) membranes. *Desalination* **149**:61–65 (2002).
- 224 Nagase Y, Ishihara K and Matsui K, Chemical modification of poly(substituted-acetylene): II. Pervaporation of ethanol/water mixture through poly(1-trimethylsilyl-1-propyne)/poly(dimethylsiloxane) graft copolymer membrane. *J Poly Sci Part B* **28**:377–386 (1990).
- 225 Nagase Y, Mori S and Matsui K, Chemical modification of poly(substituted-acetylene): IV. Pervaporation of organic liquid/water mixture through poly(1-phenyl-1-propyne)/poly(dimethylsiloxane) graft copolymer membrane. *J Appl Polym Sci* **37**:1259–1267 (1989).
- 226 Matsui K and Ishihara K, Fluorine-containing graft copolymer and adhesive and composite membrane made thereof. Sagami Chemical Research Center. US Patent 4,666,991 (1987).
- 227 Chang C-L and Chang M-S, Preparation of multi-layer silicone/PVDF composite membranes for pervaporation of ethanol aqueous solutions. *J Membr Sci* **238**:117–122 (2004).
- 228 Aoki T, Yamagiwa K, Yoshino E and Oikawa E, Temperature-sensitive ethanol permselectivity of poly(dimethylsiloxane) membrane by the modification of its surface with copoly(*N*-isopropylacrylamide/1H,1H,2H,2H-perfluorododecyl acrylate). *Polymer* **34**:1538–1540 (1993).
- 229 Krea M, Roizard D, Moulai-Mostefa N and Sacco D, New copolyimide membranes with high siloxane content designed to remove polar organics from water by pervaporation. *J Membr Sci* **241**:55–64 (2004).
- 230 Masuoka T, Iwatsubo T and Mizoguchi K, Pervaporation membranes for ethanol–water mixture prepared by plasma polymerization of fluorocarbons. II. Perfluoropropane membranes. *J Membr Sci* **69**:109–120 (1992).
- 231 Lin X, Chen X, Kita H and Okamoto K, Synthesis of silicalite tubular membranes by *in situ* crystallization. *AIChE Journal* **49**:237–247 (2003).
- 232 Lin X, Kita H and Okamoto K, Silicalite membrane preparation, characterization, and separation performance. *Ind Eng Chem Res* **40**:4069–4078 (2001).
- 233 Lin X, Kita H and Okamoto K-I, A novel method for the synthesis of high performance silicalite membranes. *Chem Commun* :1889–1890 (2000).
- 234 Sano T, Yanagishita H, Kiyozumi Y, Mizukami F and Haraya K, Separation of ethanol/water mixture by silicalite membrane on pervaporation. *J Membr Sci* **95**:221–228 (1994).
- 235 Liu Q, Noble RD, Falconer JL and Funke HH, Organics/water separation by pervaporation with a zeolite membrane. *J Membr Sci* **117**:163–174 (1996).
- 236 Sano T, Hasegawa M, Ejiri S, Kawakami Y and Yanagishita H, Improvement of the pervaporation performance of silicalite membranes by modification with a silane coupling reagent. *Microporous Mater* **5**:179–184 (1995).
- 237 Bowen TC, Kalipcilar H, Falconer JL and Noble RD, Pervaporation of organic/water mixtures through B-ZSM-5 zeolite membranes on monolith supports. *J Membr Sci* **215**:235–247 (2003).
- 238 Li S, Tuan VA, Falconer JL and Noble RD, Properties and separation performance of Ge-ZSM-5 membranes. *Micropor Mesopor Mater* **58**:137–154 (2003).
- 239 Adnadjevic B, Jovanovic J and Gajinov S, Effect of different physicochemical properties of hydrophobic zeolites on the pervaporation properties of PDMS-membranes. *J Membr Sci* **136**:173–179 (1997).
- 240 Li X and Wang S, Some characteristics of pervaporation for dilute ethanol–water mixtures by alcohol-permselective composite membranes. *Sep Sci Technol* **31**:2867–2873 (1996).
- 241 Meagher MM and Huang J, Hydrothermal gel process for preparation of silicalite particles and process for preparation of composite membrane. The Board of Regents of the University of Nebraska. US Patent 6,447,856 B1 (2002).