

Synthesis of Transportation Fuels from Biomass: Chemistry, Catalysts, and Engineering

George W. Huber, Sara Iborra, and Avelino Corma*

Instituto de Tecnología Química, UPV-CSIC, Universidad Politécnica de Valencia, Avda. de los Naranjos, s/n, Valencia, Spain

Received February 3, 2006

Contents

1.0. Introduction	4044	8.3. Aqueous-Phase Processing	4078
2.0. Biomass Chemistry and Growth Rates	4047	8.4. Supercritical Reforming of Sugars	4081
2.1. Lignocellulose and Starch-Based Plants	4047	8.5. Biological Hydrogen and Methane Production	4082
2.2. Triglyceride-Producing Plants	4049	9.0. Conversion of Nonsugar Monomers Derived from Lignocellulose	4083
2.3. Algae	4050	9.1. Lignin Conversion	4083
2.4. Terpenes and Rubber-Producing Plants	4052	9.2. Levulinic Acid Conversion	4084
3.0. Biomass Gasification	4052	9.3. Furfural Conversion	4084
3.1. Gasification Chemistry	4052	10.0. Triglyceride Conversion	4085
3.2. Gasification Reactors	4054	10.1. Transesterification	4085
3.3. Supercritical Gasification	4054	10.2. Pyrolysis and Zeolite Upgrading	4089
3.4. Solar Gasification	4055	10.3. Hydrotreating	4090
3.5. Gas Conditioning	4055	10.4. Microemulsions and Cosolvent Vegetable Oil Blends	4090
4.0. Syn-Gas Utilization	4056	10.5. Glycerol Utilization	4090
4.1. Hydrogen Production by Water–Gas Shift Reaction	4056	11.0. Ethical Considerations and Conclusions	4091
4.2. Methanol Production by Methanol Synthesis	4057	11.1. Ethical Considerations	4091
4.3. Alkane Production by Fischer–Tropsch Synthesis	4058	11.2. Overall Conclusions	4091
4.4. Other Syn-Gas Reactions	4059	12. References	4094
4.5. Analysis of Syn-Gas Processes	4059		
5.0. Bio-Oil Production	4060		
5.1. Bio-Oils by Fast Pyrolysis	4061		
5.2. Bio-Oils by Liquefaction	4063		
5.3. Bio-Oil Chemistry	4063		
5.4. Bio-Oil Problems	4066		
5.5. Economics and Thermal Efficiencies of Bio-Oil Production Methods	4066		
6.0. Bio-Oil Upgrading	4068		
6.1. Hydrodeoxygenation	4068		
6.2. Zeolite Upgrading of Bio-Oils	4068		
6.3. Bio-Oil Mixtures	4070		
6.4. Steam Reforming of Bio-Oils	4070		
6.5. Steam Reforming of Chars	4071		
6.6. Economic and Thermal Analysis of Processes for Bio-Oil Upgrading	4071		
7.0. Biomass Monomer Production	4071		
7.1. Pretreatment	4071		
7.2. Hydrolysis	4073		
7.3. Levulinic Acid	4075		
7.4. Hydrogenation/Hydrolysis	4076		
8.0. Sugar Conversion into Fuels	4076		
8.1. Ethanol Production	4076		
8.2. Zeolite Upgrading of Sugars	4078		

1.0. Introduction

Prior to the discovery of inexpensive fossil fuels, our society was dependent on plant biomass to meet its energy demands. The discovery of crude oil, in the 19th century, created an inexpensive liquid fuel source that helped industrialize the world and improved standards of living. Now with declining petroleum resources, combined with increased demand for petroleum by emerging economies, and political and environmental concerns about fossil fuels, it is imperative to develop economical and energy-efficient processes for the sustainable production of fuels and chemicals. In this respect, plant biomass is the only current sustainable source of organic carbon,^{1–3} and biofuels, fuels derived from plant biomass, are the only current sustainable source of liquid fuels. Biofuels generate significantly less greenhouse gas emissions than do fossil fuels and can even be greenhouse gas neutral if efficient methods for biofuels production are developed.^{4–7}

The U.S. Department of Agriculture (USDA) and Oak Ridge National Laboratory estimated that the U.S. could sustainably produce 1.3×10^9 metric tons of dry biomass/year using its agricultural (72% of total) and forest (28% of total) resources and still meet its food, feed, and export demands.⁸ This amount of biomass has the energy content of 3.8×10^9 boe (barrels of oil energy equivalent).² (The U.S. consumes 7×10^9 bbl/year or barrels of oil/year.⁹) According to the European Biomass Industry Association

* Corresponding author. E-mail: acorma@itq.upv.es.



George W. Huber is currently an Assistant Professor of Chemical Engineering at University of Massachusetts-Amherst. Prior to his appointment as a professor, he did a postdoctoral stay (2005–2006) with Avelino Corma at the Instituto de Tecnología Química (UPV–CSIC) where he focused on biofuels production using traditional petrochemical technologies. He obtained his Ph.D. in chemical engineering from University of Wisconsin-Madison (2005) where he helped to develop novel aqueous-phase catalytic processes for biofuels production under the guidance of Jim Dumesic. He obtained his B.S. (1999) and M.S. (2000) degrees from Brigham Young University, where Calvin H. Bartholomew was his M.S. advisor. His current research interests are in biofuels, biochemicals, and heterogeneous catalysis.



Sara Iborra was born in Carlet (Spain) in 1959. She studied Pharmacy at the Universidad de Valencia and received her Ph.D. in 1987. In the same year, she joined the chemistry department of the Technical University of Valencia as Assistant Professor, becoming Lecturer 1992 at the same department where she teaches organic chemistry. In 1991, she was appointed member of the Institute of Chemical Technology, a joint center of the Spanish National Research Council (CSIC) and the Technical University of Valencia where she joined the research group of Professor Avelino Corma. The main focus of her work is the application of heterogeneous catalysts (acid, base, and redox solid catalysts) in the synthesis of fine chemicals.

(EUBIA), Europe, Africa, and Latin America could produce 8.9, 21.4, and 19.9 EJ of biomass per year with an energy equivalence of 1.4×10^9 , 3.5×10^9 , and 3.2×10^9 boe, respectively.¹⁰ The worldwide raw biomass energy potential in 2050 has been estimated to be between 150 and 450 EJ/year, or 25×10^9 to 76×10^9 boe.¹¹ Biofuels also can have a positive effect on agriculture, and the USDA recently estimated that the net farm income in the U.S. could increase from \$3 billion to 6 billion annually if switchgrass became an energy crop.¹² (Note: All costs in this review are reported in U.S. dollars with a conversion from U.S. dollars to Euros of 1.0 to 1.2. For the purposes of this review, we assume that the energy content of 1.00 metric ton of dry lignocel-



Avelino Corma Canos was born in Moncófar, Spain, in 1951. He studied chemistry at the Universidad de Valencia (1967–1973) and received his Ph.D. at the Universidad Complutense de Madrid in 1976. He was postdoctoral in the Department of Chemical Engineering at the Queen's University (Canada, 1977–1979). He is Director of the Instituto de Tecnología Química (UPV–CSIC) at the Universidad Politécnica de Valencia since 1990. His current research field is catalysis, covering aspects of synthesis, characterization, and reactivity in acid–base and redox catalysis. Avelino Corma is coauthor of more than 600 articles and 100 patents on these subjects. He is a member of the editorial board of the most important journals in the field of catalysis, physical chemistry, and materials chemistry. He has been awarded with the Dupont Award on New Materials (1995), the Spanish National Award “Leonardo Torres Quevedo” on Science and Technology (1995), Burdiñola (1997), Premio Iberdrola de Química (1998) and F. Ciapetta Award of the North American Catalyst Society (1998), Ipatieff Lecturer at Northwestern University 2000/2001, “Rey Jaime I” Award on New Technologies (2000), François Gault Lectureship (EFCATS) (2001), Eugene J. Houdry Award in Applied Catalysis of the North American Catalysis Society (2002), Breck Award of the International Zeolite Association (2004), Gold Medal of the Royal Society of Chemistry of Spain (2005), and Doctor Honoris Causa of Utrecht University (2006).

lulosic biomass is equivalent to 3.15 barrels of oil, and 1 barrel of oil has 5.904 GJ as reported by Klass.²)

The current cost of delivered biomass is significantly cheaper than crude oil in many nations. However, the cost of biomass varies according to type and region. According to EUBIA, the cost of biomass per boe in the European Union (EU) ranges from \$11 for solid industrial residues to \$39 for energy crops such as rapeseed.¹⁰ In the U.S. it has been estimated that the cost of lignocellulosic biomass is \$5 to 15/boe,^{2,13} which is significantly below the current cost of crude oil of \$56/bbl (average cost in 2005).¹⁴ The U.S. Energy Information Association has predicted that the world oil price will continue to rise through 2006, then decline to \$47/bbl as new suppliers enter the market, and slowly rise to around \$54/bbl in 2025.⁹ Furthermore, the price difference between biomass and petroleum will be even greater if negative geostrategical considerations are added into the cost of crude oil.

In the mid-1800s, biomass supplied more than 90% of U.S. energy and fuel needs.^{1,2} In the late 1800s to early 1900s, fossil fuels became the preferred energy resource.^{1,2} In many developing countries, biomass is still a major energy source.^{1,2} Other countries that use biomass to meet a large percentage of their energy demands include Sweden, 17.5%; Finland, 20.4%; and Brazil, 23.4%.¹ *The Roadmap for Biomass Technologies*,¹⁵ authored by 26 leading experts from academia, industry, and government agencies, has predicted a gradual shift back to a carbohydrate-based economy, such that by 2030 20% of transportation fuel and 25% of chemicals in the U.S. will be produced from biomass.

As discussed in this review, the transition to the carbohydrate economy is already occurring with many companies, including traditional oil and chemical companies, such as Shell,¹⁶ UOP,¹⁷ Petrobras, Conoco-Phillips,¹⁸ Dupont,^{19,20} Dow and BP, developing the technology and infrastructure for biofuels and biochemicals production. Governmental leaders are also recognizing the importance of this fledgling industry by providing tax breaks, money, and mandates. The European Commission has set a goal that by 2010, 5.75% of the transportation fuels in the EU will be biofuels. It has been estimated that this goal requires 4–13% of the agricultural land in the EU be used for biofuel production.²¹ A number of EU countries, including Austria, Italy, Poland, Spain, Germany, and Sweden, and other countries including France, give full tax exemption for biotransportation fuels, and the U.K. gives partial tax exemption.²¹ The EU even provides a carbon credit of \$54/ha for farmers who grow energy crops used for biodiesel and bioethanol production.²¹ The U.S. government also supports biofuels and gives subsidies of \$0.14/L for ethanol production. For the transition to the carbohydrate economy to continue, it is vital that low-cost processing technologies be developed for conversion of low-cost biomass into fuels and chemicals. Chemists, scientists, and engineers will play a key role in developing these processes. The laws of economics dictate that as petroleum reserves dwindle, the price of petroleum products will increase, and biofuels eventually will be cost-competitive and even cheaper than petroleum-derived fuels.

The purpose of this review is to discuss current methods and future possibilities for obtaining transportation fuels from biomass. We will present the review in an integrated way by including not only the chemistry and catalysis involved in the process but also engineering solutions and challenges because these also can have an important impact on the global process. Life cycle and economic analyses are presented for the various processes to help researchers select areas where they can focus. These types of analyses can vary considerably and are dependent on the assumptions made with current regional information; therefore, these analyses should be viewed only as first order indicators.

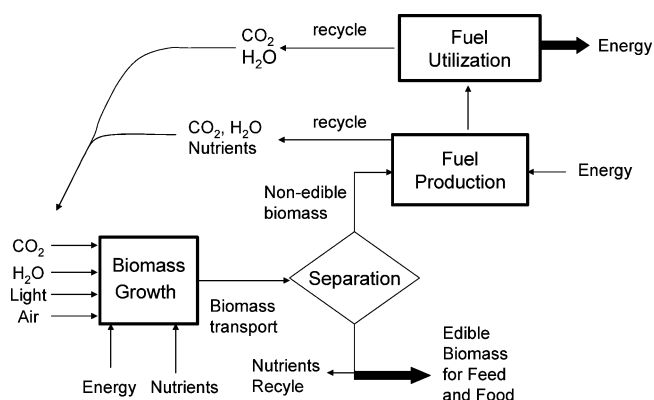

Figure 1. Sustainable production of transportation fuels from biomass in an integrated biomass production–conversion system.

Figure 1 shows an idealized biomass growth and manufacturing scheme in which CO₂, H₂O, light, air, and nutrients are the inputs for biofuel production, and energy to power transportation vehicles and food are the outputs. The three main technologies necessary for a carbohydrate economy are (1) growth of the biomass feedstock, (2) biomass conversion into a fuel, and (3) fuel utilization. In this review, we focus

on biomass conversion into a fuel, while recognizing that research in biomass production and fuel conversion are also very important. Ideally, it would be desirable to use high-yield crops that required little nutrients, fertilizers, and energy input. It would also be desirable to have a biomass conversion process that is able to convert all the energy in the biomass to a transportation fuel that could easily be fit into existing infrastructure and without air pollution. In practice, it is impossible to convert all the energy in the biomass into a fuel just as it is impossible to convert all the energy in crude oil into gasoline and diesel fuels. Conversion technologies have a wide range of energy efficiencies as will be discussed in this review. Some current biomass technologies have been criticized because they have low overall thermal conversion efficiencies, in which only a small part of the energy in the plant is converted into the final fuel product. The biofuels industry is only in its infancy, and it is likely that advances in conversion technology and process integration will ultimately improve overall energy and economic efficiency. Novel biomass conversion technologies are being developed that have higher thermal efficiencies than traditional technologies,²² and it is vital that we continue to develop novel routes. In addition, plant breeding is producing plants that have higher yields, require less water, can grow on arid land, and have lower fertilizer inputs.

Energy to power transportation vehicles is produced from the biofuel, and while we currently use spark ignition and diesel fuel engines for automobiles,^{23,24} other types of energy conversion devices for transportation vehicles are being developed such as polymer electrolyte membrane (PEM) fuel cells, hybrid electric vehicles, and homogeneous charged compression ignition engines. Important air quality control and infrastructure issues also need to be addressed in choosing the optimal biofuel. The choice of biomass feedstock will ultimately depend on crops yields, regional conditions, food coproduction, economics, and the life cycle thermal efficiency (LCTE). Biomass, which is typically in a low density form, must be collected and transported to a central processing facility so that it can be converted into transportation fuel. The edible and nonedible part of biomass can be separated, and the nonedible fraction can then be converted into a fuel. The nutrients from the biomass also can be separated and reused for further biomass growth (Figure 1).

Biomass combustion produces electricity and heat. Furthermore, although a number of other renewable options for sustainable electricity and heat production are available such as solar, wind, and hydroelectric, plant biomass is the only current renewable source of carbon that can be used directly for liquid fuels and chemicals. Our view is that the long-term optimal use of biomass is for fuels and chemical production, and other forms of renewable energy should be used for stationary power generation.

We will first discuss the chemical composition of biomass and growth rates of various species (Section 2) because the first step in producing biofuels is to have a cheap and abundant biomass feedstock. Lignocellulose (or cellulose) is the cheapest and most abundant source of biomass, and therefore we first begin with discussing its conversion. High yield lignocellulosic energy crops such as switchgrass can be grown. Another strategy is to use lignocellulosic biomass residues, such as agricultural, industrial, and forest wastes. The production of liquid fuels from lignocellulosic biomass involves removal of some oxygen, as CO₂ or H₂O, and conversion into a higher-density liquid fuel. Lignocellulosic

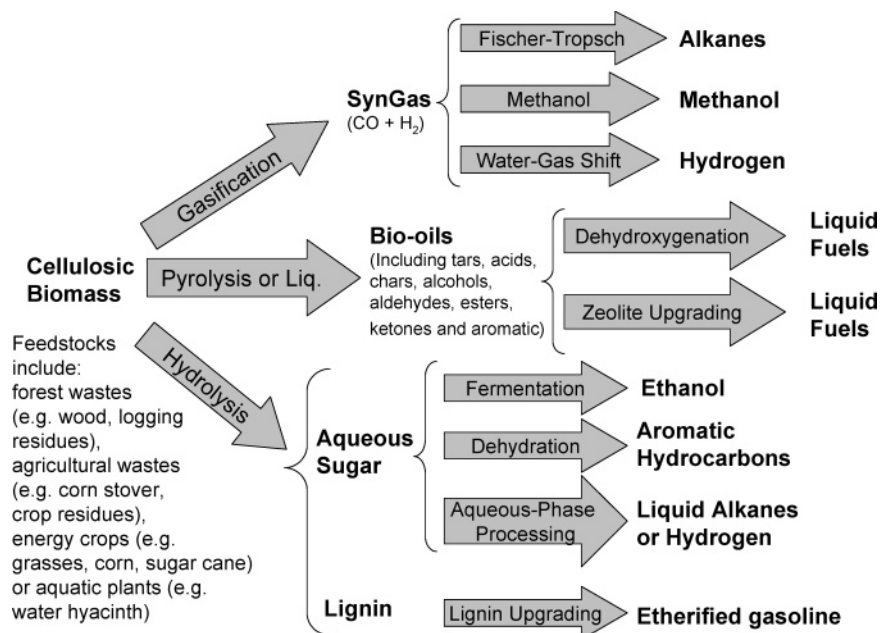

Figure 2. Strategies for production of fuels from lignocellulosic biomass adapted from Huber and Dumesic.²²

biomass typically has 40–45 wt % oxygen, and oxygen removal increases the heating value. The more oxygen removed, the higher the energy density of the fuel; however, to improve fuel combustion characteristics it may be desirable to leave some of the oxygen in the fuel.

Lignocellulosic material can be converted into liquid fuels by three primary routes, as shown in Figure 2, including syn-gas production by gasification (Section 3), bio-oil production by pyrolysis or liquefaction (Section 5), or hydrolysis of biomass to produce sugar monomer units (Section 7). Synthesis gas can be used to produce hydrocarbons (diesel or gasoline), methanol, and other fuels (Section 4). Bio-oils must be upgraded if they are to be used as transportation fuels (Section 5). Transportation fuels such as ethanol, gasoline, and diesel fuel can be produced from sugar and associated lignin intermediates (Sections 8 and 9). Another method of producing biofuels is to grow energy crops which have high energy density structures that are easily converted into liquid fuels such as vegetable oils (Section 10) or hydrocarbon-producing plants (Section 2.5). Biodiesel produced from transesterification of rapeseed or other triglycerides represents 80% of the current biofuel market in Europe and will be discussed in Section 10.²¹

Hydrogen production will be discussed in this review, even though H₂ is currently not being used as a transportation fuel. Hydrogen, which is the feedstock for PEM fuel cells, can also be used as an intermediate for biofuels production, just as it is for gasoline and diesel production. Therefore, processes to produce hydrogen may be an integral part of the future biorefinery, just as they are an integral part of the current petroleum refinery. It has previously been pointed out that the full benefits of a hydrogen economy are only realized when hydrogen is derived from renewable resources such as biomass.²⁵

Biomass and biofuels appear to hold the key for supplying the basic needs of our societies for the sustainable production of liquid transportation fuels and chemicals without compromising the needs of future generations. A major 21st century goal for academia, industry, and government should be the emergence of efficient and economical utilization of biomass resources.

2.0. Biomass Chemistry and Growth Rates

The optimal type of biomass for biofuels production will depend on regional issues such as soil quality, precipitation, and climate. Biomass can be produced not only on agricultural land but also on forest, aquatic, and arid land. Nature produces a wide range of structures from biomass. However, most biomass is built from a few basic monomer units, and in this section we describe the chemistry of different types of biomass along with biomass growth rates.

2.1. Lignocellulose and Starch-Based Plants

Plants use solar energy to combine carbon dioxide and water forming a sugar building block (CH₂O)_n and oxygen as shown in eq 1. The sugar is stored in a polymer form as cellulose, starch, or hemicellulose. Most biomass is approximately 75 wt % sugar polymer.

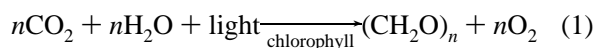

The first step for biofuels production is obtaining an inexpensive and abundant biomass feedstock. Biofuel feedstocks can be chosen from the following: waste materials (agricultural wastes, crop residues, wood wastes, urban wastes), forest products (wood, logging residues, trees, shrubs), energy crops (starch crops such as corn, wheat, barley; sugar crops; grasses; woody crops; vegetable oils; hydrocarbon plants), or aquatic biomass (algae, water weed, water hyacinth). Table 1 shows the growth rate or productivity, the lower heating value, the total production energy, and the chemical composition of different types of biomass.²⁶ Plant growth rates vary, with a typical range from 6 to 90 metric tons/ha-year or 19 to 280 boe/ha-year.² Plants typically capture 0.1 to 1.0% of solar energy, with the percentage of solar energy captured proportional to the plant growth rate. The energy inputs reported in Table 1 include the energy required to make fertilizer as well as the transportation energy associated with crop growth. The growth rates of plants and

Table 1. Chemical Composition, Energy Content, and Yield of Various Terrestrial Biomass Species^a

biomass component	corn grain	corn stover	switchgrass	sugarcane	sweet sorghum	eucalyptus	pine
productivity (dry metric tons/ha-year) ^{2,26}	7	13–24	8–20	73–87	43.8	40.0	11.6
lower heating value (MJ/dry kg) ²⁶	17.0	17.5	≈17	16.8	17.3	18.1	18.6
energy inputs (MJ/dry kg) ²⁶	1.35	1.20		0.346	2.82	5.57	7.43
energy content (GJ/ha-year)	120	228–420	136–340	1230–1460	760	720	210
energy content (boe/ha-year)	20	40–70	23–58	210–250	128	123	37
representative components (dry wt %)							
celluloses	3	36	40–45	22	35	48	46–50
hemicelluloses	6	23	31–35	15	17	14	19–22
extractives (starches, terpenes)	72	6	0	43	23	2	3
lignins	2	17	6–12	11	17	29	21–29
uronic acid			0	0.00	1	4	3
proteins	10		5–11				
ash		10	5–6	9	5	1	0.3

^aAdapted from Towler et al.,²⁶ Lynd et al.,¹³ and Klass.²

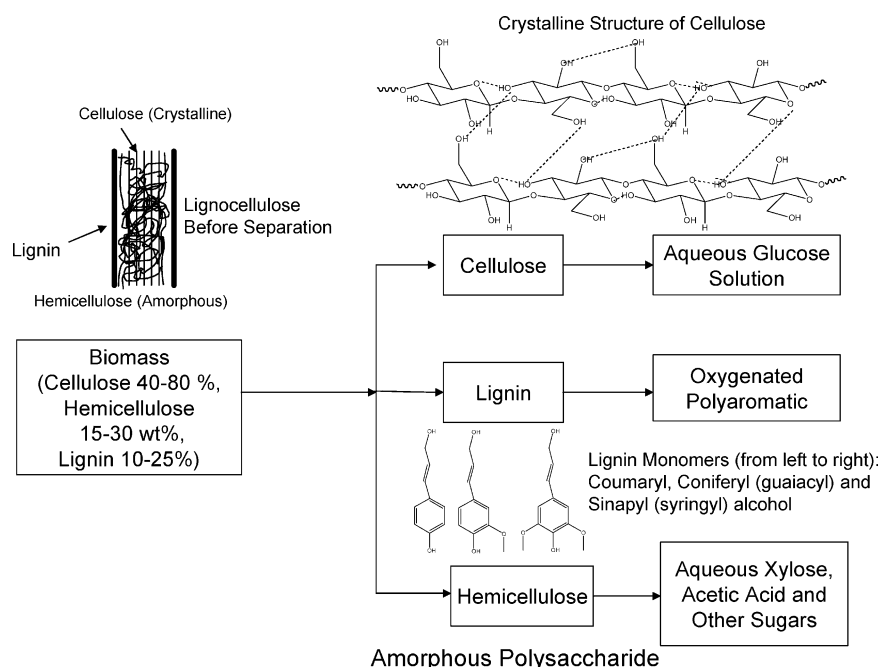

Figure 3. Structures of different biomass fractions (lignocellulose, cellulose, lignin and hemicellulose) before and after reactions. (Lignocellulose structure adapted from Hsu et al.²⁹)

the energy requirements for plant growth are dependent on plant species (Table 1). Plant breeding, biotechnology, and genetic engineering promise to develop more efficient plant materials with faster growth rates, which require less energy inputs.

Starches are a glucose polysaccharide that have α -1,4 glycoside linkages.²⁷ Starches also have a large amount of α -1,6 glycoside linkages. These α -linkages make the polymer amorphous. Human and animal enzyme systems can easily digest starches due to the α -linkages. Starches are commonly found in the vegetable kingdom (e.g., corn, rice, wheat, beans, and potatoes). When treated in hot water, starches form two principle components: water-soluble amylose (10–20 wt %) and water-insoluble amylopectin (80–90 wt %). Amylose contains only α -1,4 glycoside linkages, whereas amylopectin contains both α -1,4 and α -1,6 glycoside linkages with an approximate α -1,4 to α -1,6 linkage ratio of 20:1.

The structured portion of biomass is composed of cellulose, hemicellulose, and lignin. Cellulose (a crystalline glucose polymer) and hemicellulose (a complex amorphous polymer, whose major component is a xylose monomer unit) make up 60–90 wt % of terrestrial biomass (Table 1).

Lignin, a large polyaromatic compound, is the other major component of biomass. Extractives (Table 1) are defined as those compounds that are not an integral part of the biomass structure.²⁷ Extractives are soluble in solvents such as hot and cold water, ethers, or methanol and can include different types of carbohydrates such as sucrose from sugarcane and amylose from corn grains. Ash listed in Table 1 is biomass material that does not burn. Uronic acids are sugars that are oxidized to acids.²⁷ Other minor components of biomass include triglycerides, alkaloids, pigments, resins, sterols, terpenes, terpenoids, and waxes. Importantly, certain plants, such as rapeseed or soybeans, can have large amounts of these minor components.

Cellulose, as shown in Figure 3, consists of a linear polysaccharide with β -1,4 linkages of D-glucopyranose monomers.³ Unlike starch, cellulose is a crystalline material with an extended, flat, 2-fold helical conformation.³ Hydrogen bonds help maintain and reinforce the flat, linear conformation of the chain. The top and bottom of the cellulose chains are essentially completely hydrophobic. The sides of the cellulose chains are hydrophilic and capable of hydrogen bonding, because all the aliphatic hydrogen atoms

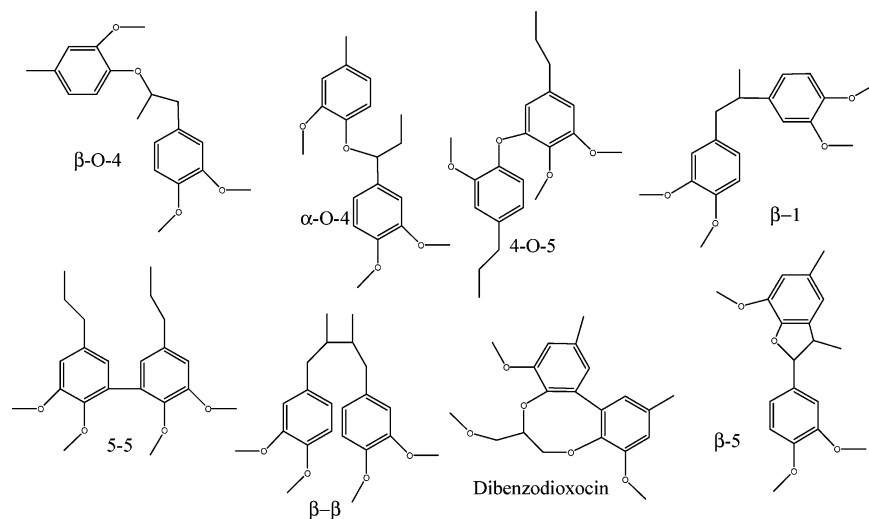

Figure 4. Common lignin linkages adapted from Chakar et al.³²

Table 2. Annual Seed and Oil Yields from Oil-Producing Plants^a

common name	species	seed yields		oil yields			
		average (kg/ha)	potential (kg/ha)	average (kg/ha)	(L/ha)	potential (kg/ha)	(L/ha)
castorbean	<i>Ricinus communis</i>	950	3810	428	449	1504	1590
chinese tallow tree	<i>Sapium sebiferum</i>	12553		5548			6270
corn (high oil)	<i>Zea mays</i>		5940			596	650
rapeseed	<i>Brasica napus</i>		2690			1074	1220
safflower	<i>Carthamus tinctorius</i>	1676	2470	553	599	888	940
soybean	<i>Glycine max</i>	1980	3360	354	383	591	650
sunflower	<i>Helianthus annuus</i>	1325	2470	530	571	986	1030

^a Adapted from Klass.²

are in axial positions, and the polar hydroxyl groups are in equatorial positions. The degree of polymerization of cellulose is approximately 10 000 to 15 000 glucopyranose monomer units in wood and cotton, respectively.²⁸ Upon partial acid hydrolysis, cellulose is broken into cellobiose (glucose dimer), cellotriose (glucose trimer), and cellotetrose (glucose tetramer), whereas upon complete acid hydrolysis it is broken down into glucose.²⁹

Hemicellulose is a sugar polymer that typically constitutes 20–40 wt % of biomass.²⁷ In contrast to cellulose, which is a polymer of only glucose, hemicellulose is a polymer of five different sugars. This complex polysaccharide occurs in association with cellulose in the cell walls. It contains five-carbon sugars (usually xylose and arabinose) and six-carbon sugars (galactose, glucose, and mannose), all of which are highly substituted with acetic acid. The most abundant building block of hemicellulose is xylan (a xylose polymer linked at the 1 and 4 positions). Hemicellulose is amorphous because of its branched nature and it is relatively easy to hydrolyze to its monomer sugars compared to cellulose.

Ten to twenty-five weight percent of biomass is typically composed of lignin which is a highly branched, substituted, mononuclear aromatic polymer found in the cell walls of certain biomass, particularly woody biomass. Lignin is often associated with the cellulose and hemicellulose materials making up lignocellulose compounds. The manner in which it is produced from lignocellulose affects its structure and reactivity. Figure 3 shows the structural monomer units of lignin. Softwood lignins are formed from coniferyl alcohol. Hardwood lignins have both coniferyl and sinapyl alcohol as monomer units. Grass lignin contains coniferyl, sinapyl,

and coumaryl alcohol.³⁰ Lignin is an irregular polymer, which is formed by an enzyme-initiated free-radical polymerization of the alcohol precursors. The bonding in the polymer can occur at many different sites in the phenylpropane monomer due to electron delocalization in the aromatic ring, the double bond-containing side chain, and the oxygen functionalities.³¹ Some lignin structural linkage units are shown in Figure 4.³²

2.2. Triglyceride-Producing Plants

High-energy density liquid molecules, which can be used to make liquid fuels, are produced in plants as triglycerides or terpenes (Section 2.4). Triglycerides, or fats and oils, are found in the plant and animal kingdom and consist of water-insoluble, hydrophobic substances that are made up of one mole of glycerol and three moles of fatty acids. Fats and oils are used mainly for cooking and food purposes, as well as for lubricants and raw materials for soap, detergents, cosmetics, and chemicals. From the more than 350 known oil-bearing crops, those with the greatest potential for fuel production, according to Peterson, are sunflower, safflower, soybean, cottonseed, rapeseed, canola, corn, and peanut oil.³³

Table 2 lists triglyceride crop and oils derived from oil-producing plants. The annual yields of oil seeds are 1000–2000 kg/ha and potentially could range from 2500–6000 kg/ha. The exception is the Chinese tallow tree, a native of subtropical China and from the Euphorbiaceae family, which has tremendous potential due to its high growth rate.² Vegetable oils have a higher heating value of approximately 40 MJ/kg;³⁴ thus, the annual energy yield of the plants listed in Table 2 ranges from 6.8 to 13.6 boe/ha-year. The annual

energy yields of lignocellulosic material (Table 1) ranges from 19 to 280 boe/ha-year, which is significantly greater than the energy yields of oil seeds. However, as will be discussed later, oil seeds can be efficiently converted into liquid fuel. The problems with vegetable oils as feedstock are that they are more expensive than cellulosic biomass, and there are limited quantities.

Currently, vegetable oils are being used for biodiesel production by transesterification (Section 9). The most common feedstocks for biodiesel production are rapeseed and sunflower in the EU, palm oil in tropical countries, and soybean oils and animal fats in the U.S.³⁵ Eighty percent of transportation biofuels in the EU are biodiesel produced primarily from transesterification of rapeseed and to a lesser extent sunflower seeds.²¹ Approximately 20% of the rapeseed produced in the EU is used for biodiesel production.²¹

All oil-producing plants contain triglycerides, carbohydrates, protein, fiber, and ash. As shown in Table 3 a soybean

Table 3. Composition of Soybeans^a

component	wt %
protein	40
triglyceride	20
cellulose and hemicellulose	17
sugars	7
crude fiber	5
ash (dry weight)	6

^a From Erickson et al.³⁶

plant only contains 20 wt % triglyceride.³⁶ The first step in the production of vegetable oils is extraction of the oils from the plant. A pretreatment step that involves cleaning, drying, and dehulling must be done prior to extraction. The oils are then extracted by one of three methods: hydraulic pressing, expeller pressing, or solvent extraction.³⁶ Two main products are produced in this process: vegetable oil and the dry solid residue known as meal. The meal has a high amount of protein and is used as a protein supplement for animal feeds.

All triglycerides can be broken into one glycerol molecule and three fatty acid molecules. The carbon chain length and number of double bonds in the fatty acids vary, as shown in Table 4, depending on the source of vegetable oil. A number of waste triglycerides are available including yellow greases (waste restaurant oil) and trap grease (which is collected at wastewater treatment plants).³⁷ Yellow grease is used in the manufacturing of animal feed and tallow, although concerns

about mad cow disease are limiting its usage as an animal feed. Trap grease has a zero or negative feedstock cost but is contaminated with sewage components.³⁷ A recent study of 30 metropolitan areas in the U.S. indicated that the U.S. produces 4.0–6.0 kg/(year-person) of yellow and trap grease, respectively.³⁷ Multiplying this number by the population of the U.S. indicates the potential production of biodiesel of 1.3 billion and 1.9 billion L/year from yellow and trap grease, respectively.³³ The U.S. consumed 160 billion L of diesel fuel in 2003 in the transportation sector;⁹ therefore, biodiesel derived from yellow and trap grease could only supply up to 2% of the annual diesel fuel consumption in the U.S. However, trap grease must be disposed of, and converting it into biodiesel would be an efficient way of using an inexpensive waste material.

2.3. Algae

Aquatic algae are another source of triglycerides as well as carbohydrates and lignin. The advantage of using microalgae is that they have very high growth rates, utilize a large fraction of the solar energy (up to 10% of the solar energy), and can grow in conditions that are not favorable for terrestrial biomass growth. From 1978 to 1996, the U.S. Department of Energy funded a program to develop renewable transportation fuels from algae, and the results of this program are reported by Sheehan et al.³⁸ Over 3000 strains of microalgae were collected as part of this program, and according to Sheehan et al. currently 300 species, mostly green algae and diatoms, are still housed at the University of Hawaii in a collection available to researchers.³⁸ Microalgae are one of the most primitive forms of plants and are microscopic photosynthetic organisms. While the photosynthesis mechanism in algae is similar to other plant material, they can convert more of their solar energy into cellular structure.

Macroalgae are commonly known as seaweed. Both microalgae and macroalgae are fast-growing marine and freshwater plants. Commercial production of triglycerides from microalgae has been estimated to be 72 000 L/ha-year (390 boe/ha-year), and it has been estimated that rates as high as 130 000 L/ha-year (700 boe/ha-year) could be accomplished with continued research.³⁹ Thus, algae have triglyceride production rates 45–220 times higher than terrestrial biomass (Table 2). Other estimates indicate that 2000 ha of land would be required to produce 1 EJ/year of fuel with microalgae.³⁸ (The U.S. consumed 42 EJ of

Table 4. Chemical Composition of Fatty Acids in Vegetable Oils^a

vegetable oil	fatty acid composition (wt %)										iodine value	sapon value
	(no. of carbons: C=C bonds)											
	8:0	10:0	12:0	14:0	16:0	18:0	18:1	18:2	18:3	22:1		
canola					1.2–6	1–2.5	52–66.9	16.1–31	6.4–14.1	1–2	110–126	188–193
coconut	4.6–9.5	4.5–9.7	44–51	13–20.6	7.5–10.5	1–3.5	5–8.2	1.0–2.6	0–0.2		6–12	248–265
corn				0–0.3	7–16.5	1–3.3	20–43	39–62.5	0.5–13.5		103–140	187–198
cotton-seed				0.6–1.5	21.4–26.4	2.1–5	14.7–21.7	46.7–58.2			90–119	189–198
olive			0–1.3	7–20	0.5–5.0	55–84.5	3.5–21				75–94	184–196
palm		0–0.4	0.5–2.4	32–47.5	3.5–6.3	36–53	6–12				35–61	186–209
peanut				0–0.5	6–14	1.9–6	36.4–67.1	13–43		0–0.3	80–106	187–196
rapeseed				0–1.5	1–6	0.5–3.5	8–60	9.5–23	1–13	5–56	94–120	168–187
soybean					2.3–13.3	2.4–6	17.7–30.8	49–57.1	2–10.5	0–0.3	117–143	189–195
sunflower					3.5–7.6	1.3–6.5	14–43	44–74			110–143	186–194
tallow (beef)				2.1–6.9	25–37	9.5–34.2	14–50	26–50			35–48	218–235

^a Adapted from Knothe et al.³⁰⁷

Table 5. Composition of Microalgae as Dry Wt % Grown under Different Conditions^a

species	growth conditions		organic component (dry wt %)					
	NaCl level (molar)	nutrients	ash	lipid (triglyceride)	protein	carbohydrate	glycerol	unknown
<i>Botryococcus braunii</i>	0	enriched	5.6	44.5	22.0	14.1	0.1	19.3
	0	deficient	7.8	54.2	20.6	14.3	0.1	10.8
	0.5	enriched	59.6	46.3	15.0	13.3	0.1	25.3
<i>Dunaliella bardawil</i>	2.0	deficient	14.7	10.4	9.7	40.4	16.4	23.1
<i>Dunaliella salina</i>	0.5	enriched	8.6	25.3	29.3	16.3	9.4	19.7
	0.5	deficient	7.7	9.2	12.5	55.5	4.7	18.1
	2.0	enriched	21.7	18.5	35.9	12.5	27.7	5.4
<i>Ankistrodesmus sp.</i>	0	enriched	4.5	24.5	31.1	10.8	0.1	33.5
<i>Isochrysis sp.</i>	0.5	enriched	12.0	7.1	37.0	11.2	0.1	44.6
	0.5	deficient	52.0	26.0	23.3	20.5	0.1	30.1
	1.0	enriched	65.9	15.3	34.7	15.5	0.1	34.4
<i>Nanochloris sp.</i>	0	enriched	13.6	20.8	33.1	13.2	0.1	32.8
<i>Nitzschia sp.</i>	1.4	enriched	20.4	12.1	16.8	9.2	0.1	61.8

^a Adapted from Klass.²**Table 6. Capital and Operating Costs in 1987 U.S. Dollars for an Open Pond System for Algae Production on a 400 ha System with Nutrient and CO₂ Recycle from Anaerobic Digesters^a**

	capital costs (\$/ha/year)		operating costs (\$/ha/year)	
	112 m ton/ha/year	224 m ton/ha/year	112 m ton/ha/year	224 m ton/ha/year
growth ponds			operating costs	
earthworks	10135	10135	CO ₂ (2 kg/kg of biomass)	6290
walls & structural	8304	8304	N (5.3% in biomass) as NH ₃	370
mixing systems	4919	4919	P superphosphate, Fe as FeSO ₄	530
carbonation system	1830	2978	flocculants	1120
instrumentation	500	500	power mixing (10,730 kWh/ha)	700
primary (settling ponds)	7479	7479	1E harvest (1,770 kWh/ha)	120
secondary (centrifuges)	3958	6467	2E harvest (1,770 kWh/ha)	370
system-wide costs			water supply (8750 kWh/ha)	570
water supply/distrib	4426	4426	other (1562 kWh/ha)	110
CO ₂ distribution	260	421	power production (6.5¢/kWh)	(-2250)
nutrient supply	781	781	salt disposal (\$67/m ton)	1130
salt disposal	833	833	maintenance	1970
buildings	573	573	labor	1390
road and drainage	521	521	total operating cost	12420
electrical distr./supply	1924	2215	capital costs (25%/year of total)	18238
machinery	417	417	total cost	30658
eng. + contg (25%)	11715	12742		
land costs (\$1,250/ha)	2500	2500		
gen-set (eng + const.)	8250	16500		
anaerobic digestion	3627	7254		
total capital cost (\$/ha)	72952	89965	total biomass costs (\$/m ton)	273
				185

^a Adapted from Sheehah.³⁸

petroleum products in 2003.⁹) Microalgae are categorized into four major classes in terms of their abundance: diatoms, green algae, blue-green algae, and golden algae. Table 5 shows the composition of various microalgae grown under different conditions. Microalgae can contain from 7 to 60 dry wt % triglycerides.²

Pilot plant tests, conducted over a six-year period, demonstrated that microalgae could be produced at productivity rates as high as 500 kg_{algae}/ha-year in a 1000 m² pond for a single day.³⁸ The ponds were an open face shallow water design where the water and algae are circulated around the pond. Nutrients and CO₂ were continually added to the algae pond. The productivity was dependent on temperature and sunlight, which varied over the course of the experiments. Ideally, algae could be produced on algae farms in open, shallow ponds where a waste source of CO₂, for example, from a fossil fuel power plant, could be efficiently bubbled into the ponds and captured by the algae.

The current limitation of microalgae is the high production cost.³⁸ Table 6 shows the production cost of algae on a large algae farm of 400 ha.³⁸ Two scenarios were used for cost estimation with algae growth rates of 112 and 224 metric tons/ha-year. The total biomass algae cost was \$273 and \$185/metric ton, which is considerably higher than the cost of lignocellulosic biomass (less than \$40/metric ton). The cost for CO₂ is 20–30% of the total cost, and using waste CO₂ from fossil fuel power plants would decrease the cost of algae production. One of the conclusions from the cost analysis is that alternative engineering designs for microalgae production would not significantly reduce the cost of microalgae production.³⁸ The limiting factor in cost analysis is microalgae cultivation issues, and according to Sheehah future research work should focus on the biological issues regarding microalgae production.³⁸ Microalgae cultivation issues are limited by the availability of water, CO₂, sunlights, and flat land. The development of low-cost harvesting processes could also reduce the cost of algae.

2.4. Terpenes and Rubber-Producing Plants

Some plant species convert carbohydrates into a mixture of isomeric hydrocarbons of molecular formula $(C_5H_8)_n$ called terpenes. Terpenes are classified by the number of isoprene units (C_5H_8) such as $(C_5H_8)_2$, monoterpenes; $(C_5H_8)_3$, sesquiterpenes; $(C_5H_8)_4$, diterpenes; $(C_5H_8)_6$, triterpenes; and $(C_5H_8)_x$, polyterpenes.² Terpenes are open acyclic chain, monocyclic, bicyclic, tricyclic, etc., and more than 23 000 structures of terpenes are known. These natural hydrocarbons can be used as transportation fuels if they can be economically produced. Natural rubber, *cis*-1,4-polyisoprene with a molecular weight from 500 000 to 2 000 000, is produced commercially from the latex of the *Hevea brasiliensis* tree, a member of the Euphorbiaceae family.⁴⁰ In 1993, 5.3 million metric tons of natural rubber was produced mainly in Malaysia, Indonesia, and Thailand.⁴⁰ The average yield in the rubber-producing countries varies from 0.4 to 1.2 metric ton/ha-year. This corresponds to approximately 2.0–9.4 boe/ha-year, which is below the production rate of vegetable oils and lignocellulosic biomass. Natural rubbers can also be produced from Guayule, a member of the sunflower family, and in 1910 50% of all commercial U.S. rubber was made from wild guayule.² During World War II, guayule plantations were used to make natural rubber in the U.S. Terpene feedstocks can also be used as building blocks for the fine chemical industry.⁴¹ While rubber is a high value product, it can also be converted into fuels by depolymerization processes.

Buchanan et al. evaluated over 206 species from 57 different families and 141 genera, that can be grown in the U.S., for hydrocarbon and rubber-producing potential.^{42,43} The plant materials have between 0.1 to 7 dry wt % oil content. Buchanan et al. claimed that the species *Cacalia atriplicifolia* and *Sassafras albidum* have the best potential for producing natural rubber in the U.S. at a rate of 2.0 metric ton/ha-year. Melvin Calvin, who won the Noble Prize for his work on photosynthesis, developed plantations in the U.S. to produce low molecular weight hydrocarbons (less than 10 000) from the Euphorbia tree, which is a relative of the natural rubber-producing trees.^{44,45} The plantations in the U.S. used the species *Euphorbia lathyris* (gopher plant) and *Euphorbia tirucalli* (African milk bush).² These plants were harvested every 6–7 months and grew to about 4 feet high. When the plants were harvested, they were crushed and the oil was extracted. The Italians had plans in 1938 to build a Euphorbia gasoline refinery, and the French have planted and harvested Euphorbia in Morocco.⁴⁵ Euphorbia plants can be grown on semi-arid land, which is not suitable for food production, with a minimum amount of water. Initial experimental results showed that *Euphorbia lathyris* could produce 8–12% of its dry weight as oil or approximately 20 boe/ha-year over a 7-month growing period with unselected seeds.² It was felt that plant breeding would be able to greatly increase the yield to up to 65 boe/ha-year.

Other species of plants, like the Brazilian tropical tree *Copaifera multijua*, can produce oil that can be used directly as diesel fuel. A single tree of this type could produce 40–60 L of oil/year, which is obtained by drilling a hole in the tree to collect the oil.⁴⁴ The hole is plugged, and every six months can be drained to collect more oil. According to Klass, “the main difficulties with the concept of natural hydrocarbon production from biomass are that most of the species that have been tested exhibit low liquid yields compared to the mass of biomass that must be harvested

and the naturally produced liquids are complex mixtures and not pure hydrocarbons.”² Field studies of *E. lathyris* indicate that the biocrude has to sell for \$100–200/bbl to be economical.

3.0. Biomass Gasification

Gasification is a process in which solid or liquid carbonaceous material, such as biomass, coal, or oil, react with air, oxygen, and/or steam to produce a gas product called syn-gas or producer gas that contains CO, H₂, CO₂, CH₄, and N₂ in various proportions.^{2,46–49} The principle difference between producer and syn-gas is that air is used to make producer gas, which has higher levels of N₂ and lower concentrations of CO, H₂, CO₂, and CH₄ than syn-gas. Producer gas is usually combusted to electricity and/or heat. Biomass gasification is an old technology, and in the mid-1940s it was used to power over a million vehicles in Europe.⁵⁰ Biomass gasification is similar to coal gasification with a few differences. Biomass gasification occurs at lower temperature than coal gasification because biomass is more reactive than coal. Biomass also contains potassium, sodium, and other alkali that can cause slagging and fouling problems in conventional gasification equipment. A number of commercial biomass gasification units exist mainly to produce heat and electricity, and in the 1970s and 1980s about 40 worldwide companies offered to build biomass gasification plants.² As discussed in Section 4.0 syn-gas is used for production of fuels and chemicals, and many industrial routes for utilization of syn-gas exist such as production of H₂ by the water gas shift reaction, diesel fuel by FTS, methanol by methanol synthesis, and methanol-derived fuels. Syn-gas is produced industrially from coal and natural gas.^{51,52}

3.1. Gasification Chemistry

A complex combination of reactions in the solid, liquid, and gas phases occurs during biomass gasification including pyrolysis, partial oxidation, and steam gasification. Table 7 shows some examples of the gasification reactions. Pyrolysis is the thermal decomposition of the feedstock into gaseous, liquid, and solid products without oxygen or steam. Partial oxidation processes use less than the stoichiometric amount of oxygen required for complete combustion. Steam reforming involves the reaction of water with the biomass-derived feedstock to produce CO, CO₂, and H₂. The water-gas shift (WGS) reaction (water and CO react to form H₂ and CO₂) and methanation (CO and H₂ react to form CH₄ and H₂O) are two other important reactions that occur during gasification. Heat to drive gasification reactions is generated in two ways: indirect gasification, where heat is generated outside the gasifier and transferred into the gasifier, or direct gasification, where the heat is generated by exothermic combustion and partial combustion reactions inside the gasifier.

Evans and Milne observed three major reaction regimes during the gasification process identified as primary, secondary, and tertiary regimes as shown in Figure 5.⁵³ This thermochemical process can be optimized to produce solid, liquid, or gaseous products depending on residence times, temperature, and heating rate as discussed in Section 5. During the primary stage of gasification solid biomass forms gaseous H₂O, CO₂, and oxygenated vapors and primary oxygenated liquids (Figure 5). The primary oxygenated vapors and liquids include cellulose-derived molecules (such

Table 7. Fundamental Reactions and Enthalpy of Selected Cellulose Gasification Reactions^a

classification	stoichiometry	enthalpy (kJ/g-mol) ref temp 300 K
pyrolysis	$C_6H_{10}O_5 \rightarrow 5CO + 5H_2 + C$	180
	$C_6H_{10}O_5 \rightarrow 5CO + CH_4 + 3H_2$	300
	$C_6H_{10}O_5 \rightarrow 3CO + CO_2 + 2CH_4 + H_2$	-142
partial oxidation	$C_6H_{10}O_5 + \frac{1}{2}O_2 \rightarrow 6CO + 5H_2$	71
	$C_6H_{10}O_5 + O_2 \rightarrow 5CO + CO_2 + 5H_2$	-213
	$C_6H_{10}O_5 + 2O_2 \rightarrow 3CO + 3CO_2 + 5H_2$	-778
steam gasification	$C_6H_{10}O_5 + H_2O \rightarrow 6CO + 6H_2$	310
	$C_6H_{10}O_5 + 3H_2O \rightarrow 4CO + 2CO_2 + 8H_2$	230
	$C_6H_{10}O_5 + 7H_2O \rightarrow 6CO_2 + 12H_2$	64
water-gas shift methanation	$CO + H_2O \rightarrow CO_2 + H_2$	-41
	$CO + 3H_2 \rightarrow CH_4 + H_2O$	-206

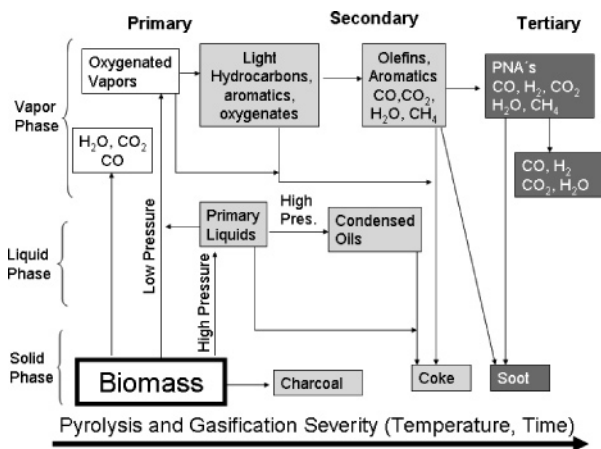
^a Adapted from Klass.²**Figure 5.** Gasification and pyrolysis reaction pathways adapted from Milne et al.⁵⁰

as levoglucosan, hydroxyacetaldehyde), their analogous hemicellulose-derived products, and lignin-derived methoxyphenols.⁵⁰ No chemical interactions are observed among the organic compounds during primary pyrolysis reactions, which are substantially free of secondary gas-phase cracking products.⁵³ Primary pyrolysis vapors are of rather low molecular weight, representing monomers and fragments of monomers. (A more complete discussion on primary chemistry is discussed in Section 5.3, since bio-oils are primary pyrolysis products.) Charcoal, which retains the morphology of the original lignocellulose, is also a major product formed during slow pyrolysis.

During secondary reactions, the primary vapors and liquids form gaseous olefins, aromatics, CO, CO₂, H₂, H₂O, and secondary condensed oils such as phenols and aromatics. The primary vapors undergo cracking (secondary reaction regimes) when heated above 500 °C, and the secondary reaction temperature regime is from 700 to 850 °C. Further heating to 850–1000 °C results in tertiary reactions from secondary products forming CO, CO₂, H₂, H₂O, and polynuclear aromatics (PNA) compounds including methyl derivatives of aromatics such as methyl acenaphthylene, methyl naphthalene, toluene, and indene. Some tertiary products, including benzene, naphthalene, acenaphthylene, anthracene/phenanthrene, and pyrene, condense to form a liquid tertiary phase. Soot and coke are formed during these secondary and tertiary processes. Coke forms from thermalolysis of liquids and organic vapors. The homogeneous nucleation of high-temperature decomposition products of hydrocarbons in the gas-phase produces soot.⁵³ The inorganic components of the gasification feedstock are usually converted into bottom ash, which is removed from the bottom

of the gasification reactor, or into fly ash, which leaves with the product gas.⁴⁹ The composition of the ash includes CaO, K₂O, P₂O₅, MgO, SiO₂, SO₃, and Na₂O.² Ash melts around 1000 °C, and it is important to keep the operating temperature below this temperature to avoid ash sintering and slagging.⁴⁷

The actual outlet gas composition from the gasification reactor depends on the biomass composition, gasification process, and the gasifying agent.^{46,48,54} Higher molecular weight hydrocarbons are called tars and are problematic because they condense in exit pipes and on particulate filters leading to blockages and clogged filters. Tars are defined as any material in the product stream that is condensable in the gasifier or in downstream processing equipment.⁵⁰ Tars cause further downstream problems and clog fuel lines and injectors in internal combustion engines. The amount of tars can be reduced by choosing the proper gasification conditions and reactor.⁵⁵

The chemical structure and formation of tars in biomass gasification is the subject of a report by Milne, Abatzoglou, and Evans.⁵⁰ According to this report, “tar is the most cumbersome and problematic parameter in any gasification commercialization effort.”⁵⁰ Tar removal, conversion, or destruction has been reported to be one of the greatest technical challenges for the successful development of commercial gasification technologies,⁵⁶ and many times new biomass gasification projects end because the cost of removing the tars is greater than the cost of project.⁵⁰ The chemical components of tars, which are a strong function of temperature, are shown in Table 8. The composition of the tars changes as the temperatures increases in the following order: mixed oxygenates, phenolic ethers, alkyl phenolics, heterocyclic ethers, polyaromatic hydrocarbons, and larger polyaromatic hydrocarbons.⁵⁷

One approach to decrease the tar concentration is to add solid catalysts inside the gasification reactor.^{58–60} Catalysts that have been added into the gasification reactor include Pd, Pt, Ru and Ni supported on CeO₂/SiO₂, and dolomite. Rh/CeO₂/SiO₂ was the most effective catalyst for reducing tar levels.⁵⁹ Nickel-based catalysts have also been tested by Baker et al. in the gasification reactor, but they deactivated rapidly due to coke formation and catalyst attrition.⁶⁰

Another approach to reduce tars is to mix alkali metal catalysts with the biomass feedstock by dry mixing or wet impregnation.⁶¹ Some of the alkali salts added to the biomass include K₂CO₃,^{62,63} Na₂CO₃,^{62,63} Na₃H(CO₃)₂,⁶² Na₂B₄O₇·10H₂O,⁶² CsCO₃,⁶³ NaCl,⁶⁴ KCl,⁶⁴ and ZnCl₂, AlCl₃·6H₂O.⁶⁴ While alkali salts decrease tar formation, they also enhance char yields as has been shown by several fundamental studies of cellulose and biomass pyrolysis compounds.^{65–68} According to Dayton, alkali metals are unattractive as commercial

Table 8. Chemical Components in Biomass Tars^a

mixed oxygenates 400 °C		phenolic ethers 500 °C	alkyl phenolics 600 °C	heterocyclic ethers 700 °C	PAH 800 °C	larger PAH 900 °C
conventional flash pyrolysis	high-temperature flash pyrolysis	conventional steam gasification	high-temperature steam gasification			
450–550 °C	600–650 °C	700–800 °C	900–1000 °C			
acids	benzenes	naphthalenes	naphthalene			
aldehydes	phenols	acenaphthylenes	acenaphthylene			
ketones	catechols	fluorenes	phenanthrene			
furans	naphthalenes	phenanthrenes	fluoranthene			
alcohols	biphenyls	benzaldehydes	pyrene			
complex oxygenates	phenanthrenes	phenols	acephenanthrylene			
phenols	benzofurans	naphthofurans	benzanthracenes			
guaiacols	benzaldehydes		benzopyrenes			
syringols			226 MW PAHs			
complex phenols			276 MW PAHs			

^a Adapted from Elliott.⁵⁷

gasification catalysts because of poor carbon conversion, increased ash content, and the difficulty in recovering alkali metals.⁵⁶

3.2. Gasification Reactors

The following steps are important in the conversion of biomass to syn-gas: biomass storage and transport, size reduction, drying, feeding, gasification, product gas conditioning, and ash disposal or recycling. Biomass particle size affects the gasification reaction rate and the product gas composition. Size control is expensive and energy intensive, and there is a tradeoff between the optimal biomass particle size and the gasification process. Specialized equipment is used to feed the solid biomass into a gasifier. Screw feeders, where the screw forms a compact, pressure-retaining plug, are used for atmospheric gasifiers, and lock-hopper feeder or a lock-hopper/screw-piston feeder for pressurized gasifiers. Inside the gasifiers the following sequence of events occurs: drying, heating, thermal decomposition (combustion and pyrolysis), and gasification.⁴⁷ The high moisture feedstock content of the feedstock has a negative influence on the thermal process efficiency and is usually the most energy-intensive part of the gasification process.

There are hundreds of different types of gasifiers in the patent literature. However, they can be divided into three principles types:⁵⁰

(1) Updraft gasifier (Figure 6A) where biomass enters from the top of the reactor and air/oxygen/steam enter from the bottom of the reactor, flow upward, and the product gas leaves from the top. In this reactor, mainly primary tars form at a level of approximately 100 g/Nm³. The advantages of updraft gasifiers are that they are a mature technology for heat production, can be used for small-scale applications, can handle feeds with a high moisture content, and there is no carbon in the ash. The disadvantages of updraft gasifiers are that they have a feed size limit, a high tar yield, and slagging potential.

(2) Downdraft gasifier (Figure 6B) in which the air or oxygen and the solid biomass enter at top of the reactor flow downward, and the product gas leaves at the bottom of the reactor. The product gas contains the lowest concentration of particulates and tars (approximately 1 g/Nm³) because most of the tars are combusted in this reactor. The flame temperature in this reactor is 1000–1400 °C, and the tars produced are almost exclusively tertiary tars. This reactor is ideal when clean gas is desired. Disadvantages of this type

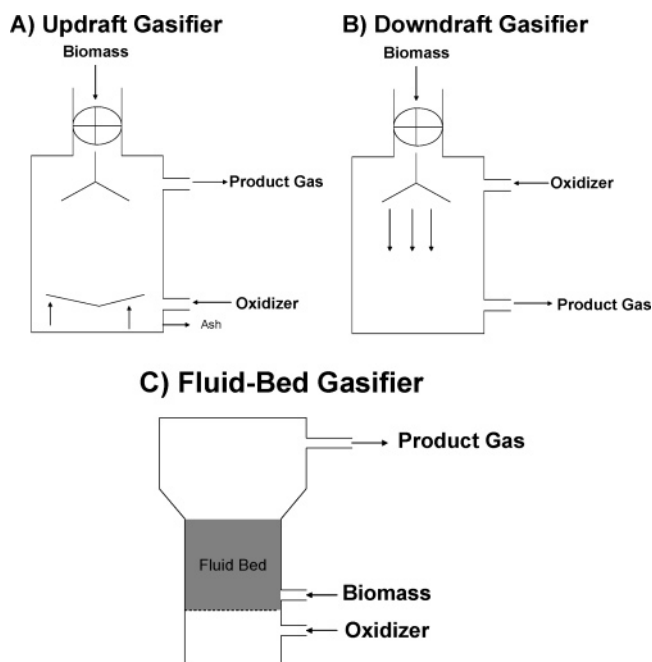

Figure 6. Gasification reactors.

of gasifier include a lower overall thermal efficiency and difficulties in handling higher moisture and ash content.

(3) Fluidized-bed gasifier (Figure 6C) where the biomass, which is previously reduced to a fine particle size, and air, steam, or oxygen enter at the bottom of the reactor. A high velocity of the gas steam forces the biomass upward through a bed of heated ceramic or silica particles. Both pyrolysis and char gasification occur in this process. This gasifier is good for large-scale applications, has a medium tar yield, and the exit gas has a high particle loading. The typical tar level, 10 g/Nm³, is an intermediate level between the updraft and the downdraft gasifier, and the tars are a mixture of secondary and tertiary tars.

3.3. Supercritical Gasification

Gasification of biomass to produce a mixture of H₂, CO, CO₂, CH₄, and char can also be accomplished in supercritical and near-supercritical water.⁶⁹ Modell and co-workers were the first to use supercritical water to gasify biomass when they gasified maple sawdust and water to produce a high BTU gas containing CO, CO₂, H₂, and CH₄ as the major components.^{70,71} The combustible product gas is mainly used

for stationary power and heat application from waste biomass sources.⁶⁹ A number of waste biomass feedstocks have been used as feeds, including manure solids, saw dust, corn fiber, and wood residue. The product gas can be converted into either a more H₂-rich stream by the water gas shift reaction (Section 4.1) or into syn-gas by steam reforming. More near term applications of this technology is to produce mixtures of H₂ and CH₄ that can be used as a substitute natural gas. One advantage of this process is that the water in the biomass is not vaporized, thereby improving the process thermal efficiency (PTE). Therefore, wet feedstocks can efficiently be processed with super/subcritical water. The product gas from this process is available at high pressure. Supercritical gasification occurs at both high temperature 500–800 °C^{72–74} and lower temperatures ranging from 350 to 600 °C with the addition of a heterogeneous catalyst such as Ru/TiO₂.^{75,76} Carbon also can be used as a catalyst for high-temperature supercritical treatment of biomass.⁷⁷ The important reactions that occur in supercritical water are the same as those that occur in gasification, including pyrolysis, hydrolysis, steam reforming, WGS, and methanation.⁷⁸ Supercritical gasification appears to be a unique technology, which will require further development. Some areas of future research include the development of highly active, stable, and selective novel catalysts, reaction chemistry studies, and reactor designs.

3.4. Solar Gasification

Concentrated solar energy can supply the energy to drive the gasification process.^{79–84} Solar gasification decreases the amount of biomass that needs to be burned in the gasification process, thus improving the PTE. Heat is provided to the gasification unit using concentrated solar gasifiers and specially designed solar reactors. Two different reactor configurations are used for solar gasification including direct irradiation of the reactants through a transparent window, usually made of fused quartz, and indirect heating through an opaque wall, in which the solar energy is absorbed by a nontransparent wall and transferred to inside particles. Solar energy is also used to dry wet biomass prior to the gasification process.

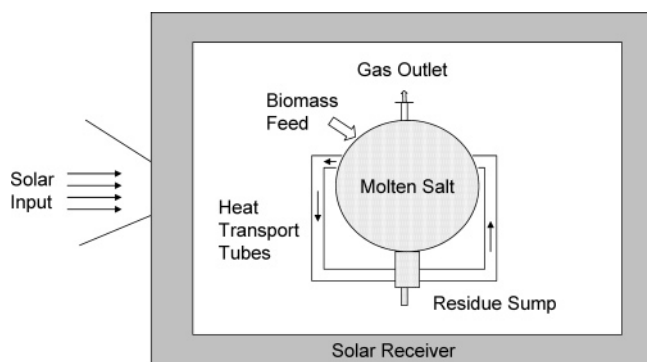

Figure 7. Solar gasification reactor concept. (Figure adapted from Adinberg et al.⁸⁴)

Figure 7 shows the concept of a solar gasification reactor based on a design by Adinberg et al.⁸⁴ The reactor is a central spherically or cylindrically shaped reactor. An array of vertical tubes are evenly distributed around the reactor. Incoming solar radiation is absorbed in these tubes, which contain a molten salt. The tubes provide thermal storage of the solar energy as well as a reaction chamber. Secondary concentrating optics (compound parabolic concentrator) can

be added to enhance the thermal concentration and reduce thermal losses. The absorbed radiation can heat the molten salt up to approximately 850 °C.

3.5. Gas Conditioning

Tars must be removed by gas conditioning, which is a general term for removing unwanted impurities from the product gas that usually involves a multistep, integrated approach.⁸⁵ A combination of three main strategies are used for gas conditioning (see Figure 8): hot gas conditioning,

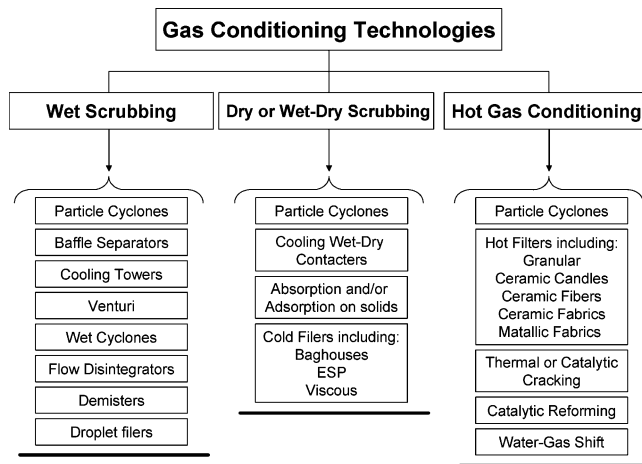

Figure 8. Gas cleaning strategies for gas from biomass gasification reactors adapted from Milne et al.⁵⁰

wet scrubbing, or dry/wet-dry scrubbing. We will not cover all the technologies for gas cleaning in this review but will present some of the more common ones. Tars can be destroyed by thermal destruction, but this typically requires very high temperatures of greater than 1000 °C. This high temperature causes material and economical problems and also produces soot. Therefore, it is usually desirable to remove the tars at a lower temperature, which requires the addition of a catalyst and often steam and/or oxygen to the product gas.

Catalysts are used to react the hydrocarbon tars with H₂O, CO₂, and/or O₂ producing CO, CO₂, CH₄, H₂, and H₂O. The CO/H₂/CO₂ ratio is adjusted during this reaction, and this ratio is very important for downstream processing of the syn-gas. Catalytic tar destruction avoids the cost of accumulating and disposing tars by converting them into useful gaseous products. If the syn-gas is to be used at high temperature then some method of hot gas cleaning at high temperature is desirable, since cooling and reheating the gas, as occurs with wet scrubbing, decreases the PTE. Recent reviews have been published on catalytic reforming of tars,^{50,56,61,86} which has been shown to be an effective method of tar removal.

According to Sutton et al. a desirable catalyst for hot gas conditioning should have the following characteristics:⁶¹

- (1) The catalyst must be effective for tar removal.
- (2) If the desired product is syn-gas, the catalyst must reform the methane.
- (3) The catalyst should provide a suitable CO/H₂ ratio for downstream processing.
- (4) The catalyst should be resistant to deactivation as a result of carbon fouling and sintering.
- (5) The catalyst should be easily regenerated.
- (6) The catalyst should be strong.
- (7) The catalyst should be inexpensive.

Two main types of catalysts are used for hot gas conditioning: nonmetallic mixed oxide catalysts and metal-based catalysts. The principle nonmetallic mixed oxide catalyst that has been used is calcined dolomite.^{50,56,61} Dolomite is an inexpensive natural sedimentary rock forming mineral consisting of calcium magnesium ore with the general formula $\text{CaMg}(\text{CO}_3)_2$ and found all over the world. Calcination at a temperature of 800–900 °C removes the CO_2 from the dolomite to form the active catalytic phase, a mixed MgO – CaO . The calcination reaction is reversible, and if the CO_2 partial pressure is too high the inactive dolomite phase will form. Thus, dolomite is not a good catalyst when the syn-gas is highly pressurized. Other problems with dolomite include severe catalyst attrition and the production of fine particulate material in fluidized bed reactors. Delgado et al.,^{87,88} Sutton et al.,⁶¹ and Dayton⁵⁶ wrote reviews on gas conditioning with dolomite catalysts. Other researchers who have studied dolomite catalysts include Simell and co-workers^{89–91} and Corella and co-workers.^{92,93} The operating conditions for using dolomite catalyst are temperatures from 700 to 100 °C and space times from 0.007 to 7 s.⁵⁶ Other nonmetallic oxide catalysts used for this reaction include MgO ,⁸⁷ CaO ,⁸⁷ and olivine (a magnesium aluminosilicate).^{58,94,95}

Ni-based catalysts are used industrially for steam reforming of naphtha and methane,^{96,97} so it is not surprising that Ni-based catalysts have proven to be very effective for hot gas conditioning of biomass gasification product gases. Ni-based catalysts have a high activity for tar destruction, methane reforming, and have some WGS activity. Tar destruction occurs by steam reforming of hydrocarbons, which can be described by three stoichiometric reactions. In the first reaction, the hydrocarbon dissociates on the metal surface (eq 2) to form CO and H_2 . Once the CO and H_2 are produced, equilibrium concentrations of CO , H_2 , CH_4 , CO_2 , and H_2O are formed according to the methanation (eq 3) and WGS (eq 4) reactions. Syn-gas can also be produced by dry reforming of methane in which the CO_2 instead of water reacts with the methane. The kinetic limiting step in methane steam and dry reforming is probably C–H bond activation.⁹⁸

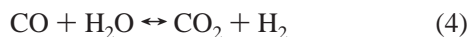
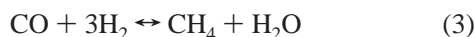
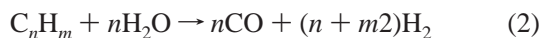

Reviews of Ni-based catalysts for hot gas conditioning are published elsewhere.^{50,56,61,86} The reaction conditions for Ni-based catalysts are temperatures of 600–900 °C and contact times of 0.01–3 s.⁵⁶ Most of the Ni catalysts were supported on low-surface area aluminas. Additives such as MgO , CaO , SiO_2 , K_2O , and CuO have been added to Ni-based catalysts.^{60,92,99–108} A number of novel catalyst compositions have been tried as well for this reaction including Ni/dolomite,¹⁰⁹ Co/MgO ,¹¹⁰ Ni/MgO ,¹¹¹ $\text{LaNi}_{0.3}\text{Fe}_{0.7}\text{O}_3$,¹¹² and $\text{Ni/LaO/Al}_2\text{O}_3$.¹¹³ The steam reforming of heavier hydrocarbons is rapid in the range of 500–600 °C, while methane steam reforming occurs more slowly at temperatures of 800 °C.^{96,97}

Several deactivation mechanisms occur with nickel-based catalysts. These include poisoning by sulfur, chlorine, and alkali metals, and coke formation. The high levels of impurities in biomass such as sulfur, chlorine, and alkaline bring new problems in regard to catalyst stability. The coke

can be removed by oxidation; however, repeated high-temperature regenerations of nickel-based catalyst lead to sintering, phase transformations, and volatilization of the nickel.

If the syn-gas is to be used at atmospheric conditions, it is possible to use a number of physical methods to remove the tars such as wet scrubbing. A disadvantage of wet scrubbing is the formation and accumulation of wastewater, as well as tar disposal. For wet scrubbing technologies, cyclones are followed by cooling or scrubbing towers as the first units where the heavy tars condense. Venturi scrubbers are usually the second wet scrubbing units. Other tar separation units include demisters, granular filters, and wet electrostatic precipitators (ESP). Wet ESP are significantly more expensive than other tar removal systems. All wet gas cleaning systems generate contaminated wastewater with organics, inorganic acids, NH_3 , and metals, which must be treated downstream by wet oxidation, active carbon adsorption, and/or gasification process ash carbon adsorption. Hot gas filtration with fabric, ceramic, or metallic filter to remove near-dry condensing tar particles is also possible and is usually combined with catalytic reforming.

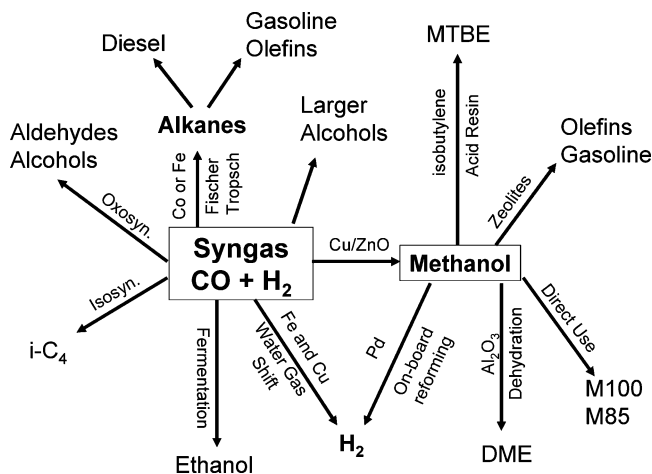

Figure 9. Pathways for fuel production from syn-gas adapted from Spath and Dayton.¹¹⁴

4.0. Syn-Gas Utilization

Figure 9 shows routes for transportation fuels and chemicals production from syn-gas.¹¹⁴ The fuels produced from syn-gas include hydrogen by the water gas-shift reaction, methanol by methanol synthesis, alkanes by Fischer–Tropsch Synthesis, isobutane by isosynthesis, ethanol by fermentation, or with homogeneous catalysts and aldehydes or alcohols by oxosynthesis. Methanol is a platform chemical used to produce a range of other chemicals and fuels including olefins, gasoline, dimethyl ether, methyl *tert*-butyl ether, acetic acid, and formaldehyde. In this section, we discuss the various processes to produce fuels and chemicals from syn-gas. We then conclude by discussing the economics and thermal efficiency of the various processes.

4.1. Hydrogen Production by Water–Gas Shift Reaction

Industrial hydrogen production, which is mainly used for ammonia synthesis and petrochemical reactions, is the major use of syn-gas. Hydrogen can be used as a fuel directly in PEM fuel cells. Hydrogen is also an essential reactant for a number of biomass conversion strategies,^{18,115} just like it is

an essential reactant in the petrochemical refinery. Depending on the technology, biomass can store H₂ in the form of a biofuel.²² The water gas-shift reaction (WGS), where CO reacts with water to form CO₂ and H₂ (eq 5), adjusts the CO/H₂ levels for further downstream processing.

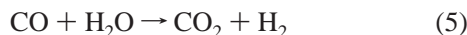

Industrial hydrogen production via the WGS reaction is done in two series of reactors: (1) a high-temperature WGS reactor at 350–500 °C with a Fe-oxide-based catalyst, and (2) a low-temperature WGS reactor at around 200 °C with a Cu-based catalyst.⁹⁷ The CO concentration decreases to about 2–3% in the first reactor and further to approximately 0.2%. Additional H₂ purification can be done with pressure swing adsorption, preferential air oxidation (PROX), or Pd membranes if high purity H₂ is required.¹¹⁶ Recently, it has been shown that nanometer-sized gold supported catalysts have very high activities for CO oxidation and WGS reactions, and Au catalysts may be used for PROX and WGS reactions.^{117–121}

Zhang et al. have designed and operated a process for the production of H₂ by gasification of switchgrass or discarded seed corn at a rate of 180 kg h⁻¹ followed by hot-gas conditioning and WGS as shown in Figure 10.^{122,123} Air

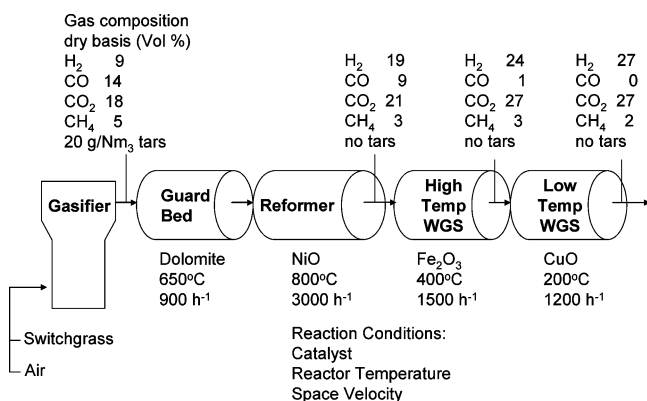
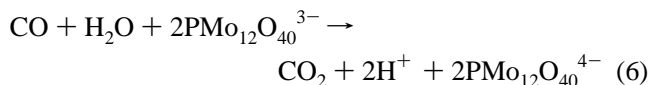

Figure 10. Pilot plant for H₂ production by gasification of switchgrass.^{122,123}

fluidized the switchgrass in a pilot-scale fluidized bed reactor rated at 800 kW. A slip stream (5 L min⁻¹) from the gasification reactor was sent to the hydrogen production process. First trace contaminants and some tars were removed in a dolomite guard bed at 600 °C. The unreacted tars and the lighter hydrocarbons were converted into CO and H₂ by steam reforming with a Ni catalyst at 800 °C. The CO then reacted with steam to form H₂ and CO₂ in the high-temperature WGS reactor with an Fe–Cr catalysts followed by a low-temperature WGS reactor with a Cu–Zn–Al catalysts that converted more of the CO. No loss of catalytic activity was observed during operation over an 8–16 h time period, although deactivation in a short time period would be difficult to detect at the high conversions in the study. The catalysts were characterized and had deposits of sulfur, coke, and chlorine as well as a change in pore size after 8–16 h time-on stream.

An exciting alternative to the WGS and/or PROX reaction was recently reported and tested at the laboratory scale by Kim et al. in which CO is converted to CO₂ and electricity using aqueous polyoxometalates at significantly higher rates than the WGS reaction.^{124–126} The overall reaction (eq 6) involves oxidation of CO and water to CO₂ and protons with

polyoxometalates (POM), such as H₃PMo₁₂O₄₀, in the presence of a gold catalyst. The aqueous solution of reduced POMs and protons can then be used to produce electricity at the anode of a PEM fuel cell. The POM solution is reoxidized in the process. The rate of CO consumption, defined as turnover frequency of 0.75–5 s⁻¹ (turnover frequency is defined as moles of CO/(moles of metal surface sites-second)), at room temperature by using POMs is higher than the rate of WGS at 220 °C.



Biological methods are also available to do the WGS reaction with photoheterotrophic bacteria at ambient temperature and pressure.¹²⁷ The rate for H₂ production with biological methods is currently very low and has been reported to be 96 mmol of H₂ L⁻¹ h⁻¹.¹²⁷ It has been estimated that a 1250 L biological reactor would be required to power a 5 kW PEM fuel cell.

4.2. Methanol Production by Methanol Synthesis

Methanol, which is one of the top 10 chemicals produced globally, is produced by the methanol synthesis reaction from syn-gas feedstocks, usually with Cu/ZnO-based catalysts, at 220–300 °C and 50–100 bar.⁹⁷ In 1923, BASF built the first synthetic methanol plant on a large scale using a Zn/Cr₂O₃ catalyst. Prior to this, methanol was produced by slow pyrolysis of wood. Methanol synthesis is a combination of two exothermic reactions, the WGS reaction and hydrogenation of CO₂ to methanol, eqs 7 and 8, respectively.^{128–131} The net reaction of these two reactions is shown in eq 9. Methanol can be produced from H₂–CO or H₂–CO₂ mixtures, but the rate of methanol production is 7 times higher for H₂–CO–CO₂ mixtures.¹³² Transient in-situ kinetic experiments suggest that at industrially conditions, methanol synthesis occurs via hydrogenation of CO₂.¹³³ For activity and selectivity reasons, the desired stoichiometric ratio for the syn-gas, defined as (H₂–CO₂)/(CO+CO₂) should be slightly above 2.¹³⁴

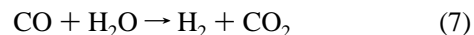

Methanol synthesis is thermodynamically favorable at low temperatures and high pressures. Byproducts of the methanol synthesis reaction include methane, dimethyl ether, methyl formate, higher alcohols, and acetone. One of the challenges in using methanol synthesis is to design reactors that efficiently remove the heat from this exothermic reaction. Copper catalysts for methanol synthesis typically last 2–5 years and undergo slow deactivation by sintering and poisoning. Copper catalysts are sensitive to poisoning by sulfur and the syn-gas should be purified to less than 0.1% sulfur.⁹⁷ The presence of Cl in the gas phase will result in sintering of the Cu catalyst. In commercial units, the conversion of syn-gas is limited to about 25% per pass due to thermodynamic constraints.¹³⁵

Methanol is a starting material for a number of other fuels and chemicals including olefins, gasoline, dimethyl ether, methyl *tert*-butyl ether (MTBE), acetic acid, hydrogen, and

formaldehyde. The largest industrial use of methanol include formaldehyde (35% of methanol use), MTBE (25% of methanol use), and acetic acid (9% of methanol use).¹¹⁴ Methanol can be used directly as a transportation fuel in internal combustion engines,^{136–138} as a feed for direct methanol fuel cells,^{139,140} or to produce H₂ for fuel cell applications by on board reforming.^{141–145} Concerns about methanol's toxicity, water solubility, low vapor pressure, and phase separation have limited its use as a direct fuel.¹⁴⁶ U.S. regulations limit the blending of methanol in gasoline to a maximum concentration of 0.3 vol %.

MTBE is used primarily as a gasoline blend, and it oxygenates gasoline thereby decreasing air pollutants produced during gasoline combustion. MTBE is produced by reacting isobutene with methanol in the presence of an acidic catalyst as shown in eq 10. Solid acids, zeolites (H-ZSM-5), and especially sulfonic acid ion-exchange resins are some of the catalysts used for MTBE production.^{147,148} Recently, MTBE has caused environmental problems, due to MTBE groundwater contamination owing to leaking tanks in gas stations, and plans are being made to phase out MTBE as a gasoline additive in the U.S.

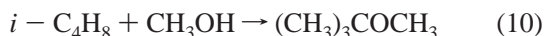

Methanol also can be converted to olefins or gasoline.^{149,150} This process was first discovered in the 1970s by Mobil scientists who showed that zeolite catalyst, such as ZSM-5, could convert methanol into dimethyl ether (DME) followed by light olefins, and then higher olefins, paraffins, aromatics, and naphthenes. A commercial plant that produced gasoline from methanol (MTG) was operated in New Zealand by Mobil from 1981 to 1984 and produced 14 500 bbl/day. The first step in this process is dehydration of methanol at 300 °C and 27 atm to yield an equilibrium mixture of methanol, dimethyl ether, and water, which is then introduced to a reactor containing ZSM-5 at 350 °C and 20 atm to produce hydrocarbons and water. The selectivity to gasoline is greater than 85% with the other 15% being light petroleum gas.¹³⁵ Approximately 40% of the gasoline produced by MTG is aromatics. This process can also be modified to produce lighter olefins such as propylene, ethylene, and butylenes, and UOP currently has a commercial process to produce olefins from methanol using silicoaluminophosphate (SAPO) catalysts.¹⁵⁰ Other eight-membered ring zeolites, such as chabazite,¹⁴⁹ ITQ-3,¹⁵¹ ITQ-29,¹⁵² and ITQ-32,¹⁵³ offer new opportunities for production of olefins from methanol.

Dimethyl ether can be used as a diesel fuel and is produced in a two-step process involving formation of methanol, followed by dehydration of the methanol. Recent improvements in DME involve the development of bifunctional catalysts to produce DME in a single gas-phase step^{154,155} or the use of a slurry reactor.^{156,157} Higher alcohols, including ethanol, 2-propanol, and butanol are made from syn-gas with catalysts consisting of Cu, Zn, Mo, or Cr, promoted with alkali metals. Commercial processes for production of mixed higher alcohols have been developed by Snamprogetti-Topsoe, Lurgi, Dow, and IFP-Idemitsu.¹⁵⁸ The important reactions that occur in higher alcohol synthesis include methanol synthesis, WGS reaction, CO beta addition, ethanol homologation, higher alcohol homologation, condensation, dehydration, DME formation, branched iso-alcohols, and methyl ester synthesis.¹¹⁴

Onboard processing of liquid fuels is one of the most promising methods of supplying hydrogen to proton-

exchange membrane (PEM) fuel cells. Methanol due to its high energy density, low sulfur content, and safe handling/storage capabilities is one of the leading candidates for fuel-cell-driven automobiles. Methanol can be converted into H₂ by steam reforming (eq 11), or partial oxidation of methanol (eq 12). In autothermal reforming of methanol or oxidative methanol reforming the heat from the exothermic partial oxidation reaction balances the endothermic reforming reaction as shown in eq 13.¹⁴³ Aqueous-phase reforming (APR) of methanol, where liquid water reacts with liquid methanol, also can be used to produce H₂.^{25,159,160} Methanol reforming and autothermal reforming usually occur at relatively low temperature (150–350 °C) and generate H₂ with low levels of CO. A number of catalysts have been used for this reaction including Pd/ZnO, Pt/ZnO, and Cu/ZnO.^{141–145} Direct methanol fuel cells also appear to be promising; however, according to Dillon et al. the biggest limitation is that they have low kinetic rates of methanol oxidation.¹⁴⁰

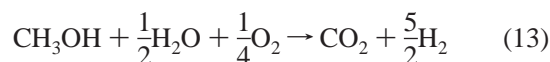
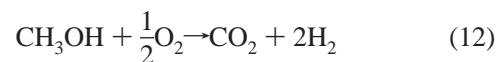

4.3. Alkane Production by Fischer–Tropsch Synthesis

The Fischer–Tropsch synthesis (FTS) is an industrial process to produce alkanes from syn-gas using Co-, Fe-, or Ru-based catalysts. This technology was first developed in the early 1900s and used by Germany during the 1930s and 1940s to produce liquid fuels from syn-gas-derived coal.^{161,162} After World War II Sasol, in South Africa, used FTS (and still uses FTS today) to produce gasoline and diesel fuel.¹⁶³ Shell also uses FTS in a Malaysian plant to produce lubes and diesel fuel. Several oil companies are currently using or building FTS units to produce liquid fuels from natural gas-derived syn-gas in remote locations. The overall reaction in FTS is shown in eq 14. The WGS reaction, and the reverse of the WGS reaction, occur during FTS (particularly on Fe catalysts) adjusting the CO/H₂ ratio, particularly when low H₂/CO feed ratios are used.



The products from FTS are a range of mostly straight chain alkanes ranging from C₁ to C₅₀ governed by the Anderson-Schulz-Flory (ASF) polymerization model. The alkane products are dependent on the chain growth probability parameter in the ASF model, and gasoline or diesel fuel cannot be made selectively using FTS without producing a large amount of undesired byproducts as shown in Figure 11. Methane formation is usually significantly higher than that predicted by the ASF model. Modifying the catalytic properties can be used to tune the product selectivity,^{164,165} but attempts to overcome the ASF distribution have not yet been successful.¹⁶⁶ However, recent results show that it is possible to directly produce high octane gasoline in a FTS process by coupling the Co or Fe catalyst with a ZSM-5 zeolite catalyst that cracks the longer chains in-situ producing gasoline range fuel high in branched paraffins and aromatics as shown in Figure 12.^{167,168} Thus, Fe catalysts supported on ZSM-5 had higher alkane carbon distributions for gasoline

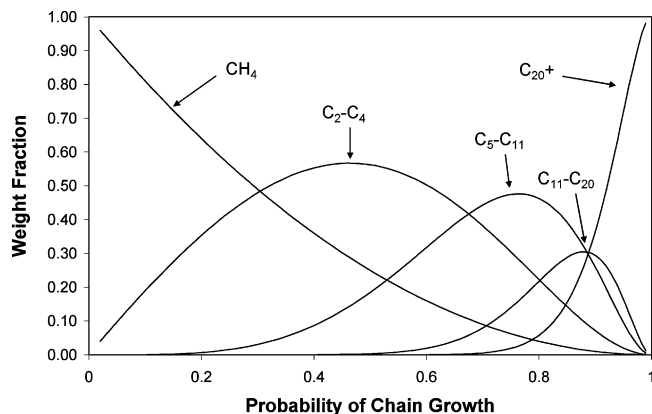

Figure 11. Idealized product distribution from Fischer-Tropsch synthesis based on the Anderson-Schulz-Flory model.

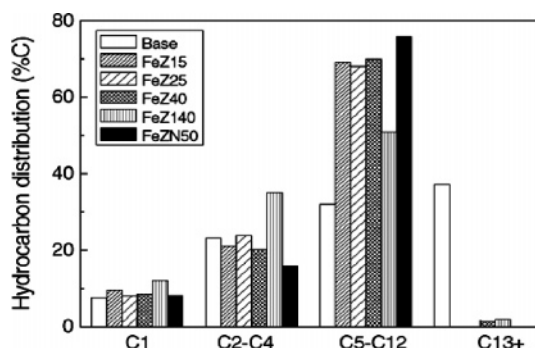

Figure 12. Hydrocarbon distribution for Fischer-Tropsch synthesis with Fe-Co-K (base), Fe supported on ZSM-5 with Si/Al ratios of 15, 25, 40, and 120 (FeZ15, FeZ25, FeZ40, and FeZ120, respectively), and Fe supported on nanocrystalline ZSM-5 with a Si/Al ratio of 50 (FeZN50). Reprinted with permission from ref 167. Copyright 2005 Elsevier.

range fuel than did traditional Fe supported catalysts. Currently, the goal in FTS is to produce heavy waxes and then hydrocrack the waxes to gasoline and diesel fuel. Fixed-bed, slurry-bed, and fluidized bed reactors are used commercially for FTS.^{97,166}

FTS fuels were produced from biomass-derived syn-gas in a demonstration pilot plant in The Netherlands that successfully ran for over 1000 hours with a joint venture between Shell and the Energy Research Centre of The Netherlands (ECN).¹⁶⁹ Several different concepts were explored for this pilot plant, which consisted of a fluidized bed gasifier with wood as the feed, followed by wet gas cleaning, gas conditioning, WGS reaction, FTS, and then catalytic cracking of the FT waxes to produce a premium sulfur-free diesel fuel. The yield of diesel fuel from wood by FTS of biomass-derived syn-gas is 120 L_{dieselfuel}/metric ton_{biomass},¹⁷⁰ which is lower than the yield of ethanol from wood reported by a NRELS process, via hydrolysis and fermentation, which is 320 L_{ethanol}/metric ton_{biomass},¹⁷¹ however, synthetic natural gas and electricity are also produced as byproducts of FTS. Boerringer has predicted that future improvements could allow the yield to increase to 210 L_{dieselfuel}/metric ton_{biomass}.

4.4. Other Syn-Gas Reactions

Fermentation of syn-gas with the anaerobic bacterium, *Clostridium ljungdahlii* produces ethanol.¹⁷²⁻¹⁷⁵ The fermentation performance is not adversely affected by a specific CO/H₂ ratio, and both CO and H₂/CO₂ mixtures can be used

simultaneously even though the bacteria generally prefer CO to H₂. Ethanol can also be produced from fermentation of coal or natural gas-derived syn-gas.¹⁷² Acetic acid is a byproduct of this fermentation process. According to Spath and Dayton, the ethanol yields for syn-gas fermentation are similar to those for direct fermentation of corn-derived starches.¹⁷⁶

Other reactions that occur with syn-gas include oxysynthesis and isosynthesis. Oxysynthesis or hydroformylation involves reaction of syn-gas with olefinic hydrocarbons to form an isomeric mixture of normal and iso-aldehydes.^{114,135} This reaction is highly exothermic and occurs in the presence of homogeneous metal carbonyl catalysts. Today, hydroformylation is the fourth largest use of syn-gas and used in the production of butanol, propanol, isobutanol, and ethylhexanol. Isosynthesis involves the conversion of syn-gas to isobutene and isobutene at extreme conditions (450 °C and 150–1000 atm) over thorium or zirconium-based catalysts. This reaction is not currently commercially practiced, and current efforts are being made to develop catalysts that work well at less severe reaction conditions.¹¹⁴

4.5. Analysis of Syn-Gas Processes

In this paper, we will use two types of thermal efficiency analysis: the process thermal efficiency (PTE) and the life cycle thermal efficiency (LCTE). The PTE is defined as the energy in the product fuel divided by the energy of the biomass feedstock. The LCTE is the energy in the product fuel divided by the energy of the biomass feedstock plus the fossil fuel energy required to grow the biomass, transport the biomass, produce the process machinery, produce any fossil fuel used, and transport the final fuel. PTEs are relatively easy to calculate compared to LCTE. Different assumptions made during life cycle analysis can drastically change results. Different research groups have arrived at a wide range of conclusions regarding life cycle analysis of biofuels.¹⁷⁷

Spath and Dayton analyzed the PTE and economics of syn-gas-derived fuels with a feedstock cost of \$33/dry metric ton, and the results of their analysis are shown in Table 9.¹¹⁴ In their economic analysis, they concluded that syn-gas production accounts for at least 50% and up to 75% of the final product cost. As can be seen from Table 9, the cost of syn-gas-derived fuels on an energy basis increases in the order H₂ < methanol ≈ ethanol < FTS liquids. The cost of production of ethanol from fermentation of syn-gas is reported based on limited data and with a high degree of uncertainty.¹⁷⁶ This analysis is consistent with the results of Hamelinck et al. who have also studied the economics of production of FT transportation fuels, methanol, and hydrogen from biomass and concluded that FTS diesel is 40–50% more expensive than methanol or hydrogen.^{178,179}

Also included in Table 9 is the current cost of various petroleum-derived fuels. These costs are dependent on crude oil and natural gas prices, which can be volatile. Figure 13 shows the FOB price of diesel fuel and gasoline (in New York Harbor) as a function of crude oil price for the years 1994–2005. During this time period, the cost of diesel fuel ranged from 11.6 to 43.3 ¢/L.¹⁴ The cost of diesel fuel derived from petroleum (currently 43.3 ¢/L) is lower than the cost of diesel fuel via FTS (0.71–0.95 ¢/L). However, according to Hamelinck et al. FTS biomass-derived transportation fuels are currently economical competitive with fossil diesel in Europe when the biofuels are exempted from excise duty and value added taxes (11.6 and 3.5 Euros/GJ

Table 9. Thermal Efficiency and Selling Price of Syn-Gas-Derived Fuels^a

products	process thermal efficiency	life cycle thermal efficiency	minimum selling price from Spath ¹¹⁴		commercial prices 2003 from Spath and Dayton ¹¹⁴
	energy _{product} /energy _{feed} (LHV)	energy _{product} /energy _{feed} (LHV)	\$/GJ (LHV)	\$/L or \$/kg	\$/L or \$/kg
natural gas to H ₂	0.83				
coal to H ₂	0.44				
biomass to H ₂	0.36–0.73	0.27–0.55	9–17	1.1–2.0/kg	0.7–1.4/kg ^b
natural gas to FTS liquids	0.54–0.63				
biomass to FTS liquids	0.16–0.43	0.12–0.33	19–25 ^c	0.71–0.95/L	0.20/L ^d
natural gas to MeOH	0.61				
biomass to MeOH	0.29–0.65 ^e	0.22–0.49	13–14	0.21–0.24/L	0.08–0.18/L
ethanol via syn-gas fermentation	0.35	0.27	14	0.34/L	0.26–0.37/L
olefins (propylene) from biomass-derived MEOH	0.21–0.46	0.16–0.35	18–20	0.81–0.92/kg	0.29–0.50/kg

^a Adapted from Spath and Dayton.¹¹⁴ Cost of biomass used in the analysis is \$33/dry metric ton. The PTE for syn-gas production is 0.77 according to Prins et al.¹⁸⁰ Commercial prices are reported by Spath and Dayton who wrote their report in 2003 when crude oil prices were approximately \$25–31/bbl.¹⁴ Life cycle thermal efficiencies are estimated with data from Towler²⁶ for eucalyptus tree, which is also reported in Table 1 and assumes that 5.57 MJ_{fossil fuel}/kg_{wood} and a LHV of 18.1 MJ/kg_{wood}. ^b Hydrogen cost is for on-site usage. If H₂ is to be sold as a product, it must be compressed, which increases the cost. The cost of liquefying and transportation can increase the cost to \$2.2–3.2/kg. ^c Hamelinck et al. have estimated the current cost of FTS liquid from biomass to be \$19/GJ and that the cost could decrease to \$11/GJ in the future.¹⁷⁹ ^d The price of diesel fuel is dependent on the price of crude oil and in 2005 the current FOB spot price of diesel fuel in the U.S. was \$0.44/L with crude oil prices of \$57/bbl. ^e The process thermal efficiency for conversion of wood into methanol has been estimated by Moffatt and Overend to be 0.50.¹⁸⁸

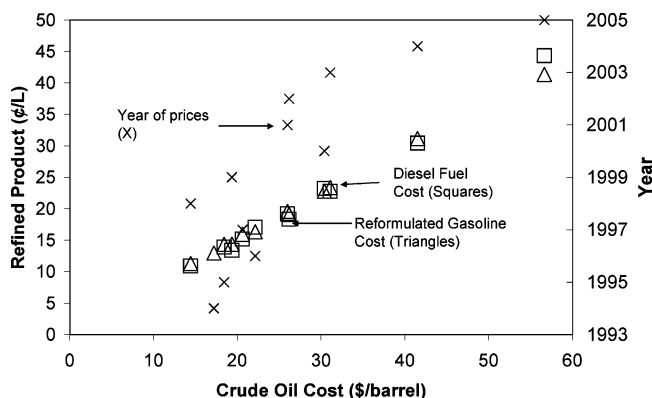

Figure 13. FOB spots prices for low sulfur diesel fuel and reformulated gasoline in New York Harbor as a function of crude oil price. (Key: diesel fuel, squares; reformulated gasoline, triangle; and year, X. Source: Energy Information Association.¹⁴)

in the Netherlands 2002).¹⁷⁹ The cost of H₂ derived from biomass (\$1.1–2.0/kg) is within the same price range of the market price of H₂ (\$0.7–1.4/kg). Methanol from biomass (\$0.21–0.24/L) is slightly more expensive than the market price methanol in 2003 (\$0.08–0.18/L). Importantly, these costs are estimates that are not based on data from pilot plant studies.

Gasification and other syn-gas reactions are already established commercial processes; however, further process integration and improvement must be made. The advantages of production of fuels by this route are that all of the biomass is converted into syn-gas, and these are established technologies. The disadvantage of all of these processes is that they have a low PTE (typically around 16–50%); thus, a large amount of energy that was previously in the biomass is irreversibly lost in the biomass conversion steps. Gasification of the biomass has a PTE of 75%, which represents the maximum PTE possible from syn-gas-derived fuels. Adding the energy required to produce and transport the biomass decreases the thermal efficiency even further.

Prins et al. modeled the production of Fischer–Tropsch fuels from sawdust and reported the PTE (defined as energy in diesel fuel plus electricity divided by energy in biomass)

to be 36%, with 34% of the energy in the diesel fuel and the other 2% in electricity.¹⁸⁰ These results are consistent with those of Spath and Dayton shown in Table 9. The major exergy losses (exergy is the amount of energy in a system that is able to do work) in a FTS plant are in the gasification (23% loss), steam generation (9% loss), and power generation (24% loss) system.¹⁸⁰ The exergy losses in the gasifier are intrinsic because gasification is a partial oxidation process that decreases the heating value; however, these losses can be minimized by drying the feedstock and optimizing the gasification system. If more of the syn-gas is converted into liquid fuels, then the efficiency of the FTS process will increase, and the energy losses in the power generation system will decrease. The maximum possible overall energy efficiency for a FTS plant would be 46.2%, consisting of 41.8% fuels and 4.4% electricity.¹⁸⁰

Figure 14 summarizes the major processes for conversion of biomass into fuels, chemicals, and electricity by biomass gasification. There are a number of processes for converting biomass into liquid fuels including gasification, particulate removal, hot gas conditioning, WGS, and synthesis gas conversion. The fundamental chemistry in these processes is not well understood, and it is likely that having a more scientific understanding of these processes will lead to more technological breakthroughs. Improved catalysts are needed for a number of these processes. It is likely that gasification will continue to play a major role in electricity production from biomass. Production of fuels by gasification of biomass and subsequent syn-gas conversion has been proven at the pilot plant scale. The extent to which this technology plays a role in the future biofuel industry will depend on whether more economical and energy-efficient biomass conversion strategies are developed.

5.0. Bio-Oil Production

In addition to producing gases, thermochemical treatment of biomass can also produce liquids and solids. The residence time, heating rate, and temperature are the parameters that determine if thermochemical biomass treatments produce liquids, gases, or solids (Table 10). Process conditions that

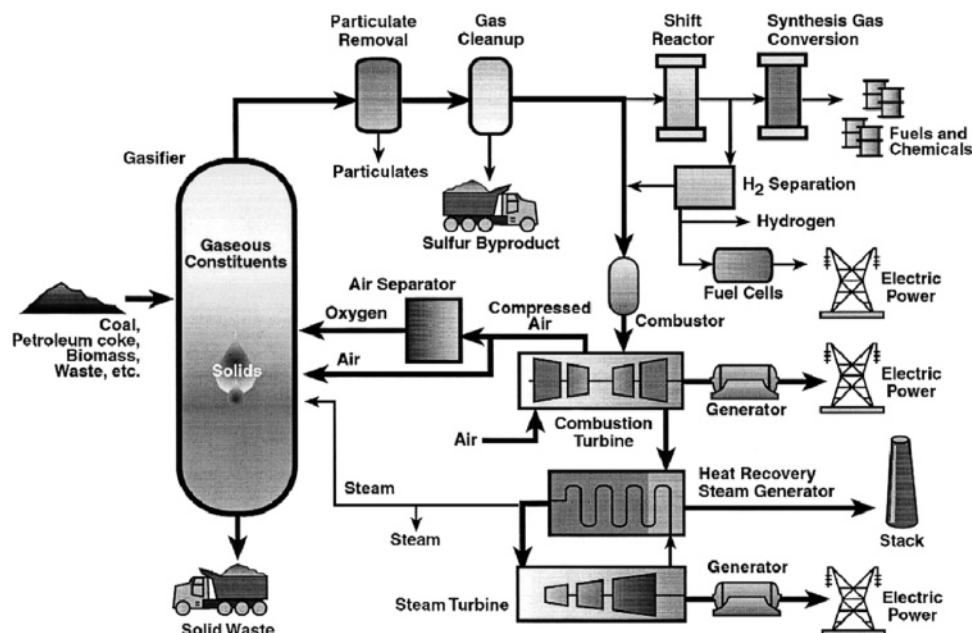

Figure 14. Summary of gasification technology for production of liquid fuels and electricity from biomass. Reprinted from ref 181 with permission. Copyright 2001 Elsevier.

Table 10. Biomass Pyrolysis Technologies, Reaction Conditions, and Products^a

name	residence time	temp (°C)	heating rate	major products
conventional carbonization	hours-days	300–500	very low	charcoal
pressurized carbonization	15 min-2 h	450	medium	charcoal
conventional pyrolysis	hours	400–600	low	charcoal, liquids, gases
conventional pyrolysis	5–30 min	700–900	medium	charcoal, gases
flash pyrolysis	0.1–2 s	400–650	high	liquids
flash pyrolysis	<1 s	650–900	high	liquids, gases
flash pyrolysis	<1 s	1000–3000	very high	gases
vacuum pyrolysis	2–30 s	350–450	medium	liquids
pressurized hydrolysis	<10 s	<500	high	liquids

^a Adapted from Klass.²

favor liquid products are short residence times, fast heating rates, and moderate temperatures. The liquids produced by pyrolysis are nonthermodynamically controlled products. Optimal residence times and temperatures are necessary to freeze the desired intermediates. Long residence times at low temperature produce primarily charcoal, and high temperatures produce mainly gas products. The slow pyrolysis of wood (24 h residence time) was a common industrial technology to produce charcoal, acetic acid, methanol, and ethanol from wood until the early 1900s. According to Klass,² the average product yield per cord of seasoned hardwood was 1025 kg of pyrolyligenous acid (containing 80% water, 9% tars and oils, 7% acetic acid, and 4% methanol and acetone), 454 kg of charcoal, and 212 m³ of fuel gas with a heating value of 9–11 MJ/m³.

In this section, we discuss how to produce liquid oils, called bio-oils by thermochemical treatment of biomass. Liquefaction and pyrolysis are the two major technologies to produce bio-oils. Pyrolysis oils are water soluble and have a higher oxygen content than liquefaction oils. Liquefaction occurs at 50–200 atm and 250–325 °C, whereas pyrolysis occurs from 1 to 5 atm and 375–525 °C. Pyrolysis has a lower capital cost than liquefaction, and many pyrolysis technologies are currently being used commercially. The advantage of bio-oil production is that it requires only a single reactor, and a large fraction of the biomass energy (50–90%) can be converted into a liquid.

A wide range of feedstocks can be used for bio-oil production, including wood, black liquor, agricultural wastes, and forest wastes. Bio-oils are a mixture that can contain more than 400 different compounds, including acids, alcohols, aldehydes, esters, ketones, and aromatic compounds.¹⁸² Commercially, bio-oils are used as boiler fuel for stationary power and heat production, and for chemical production. Bio-oils must be upgraded if they are to be used as transportation fuels, which is the subject of Section 6.0.

5.1. Bio-Oils by Fast Pyrolysis

Bio-oils are produced by pyrolysis processes where the biomass feedstock is heated in the absence of air, forming a gaseous product, which then condenses. Slow pyrolysis produces large amounts of coke, which can be used as a solid fuel, whereas fast pyrolysis produces bio-oils in high yields of up to 80 wt % dry feed. Bridgwater and Peacocke have recently completed a review summarizing fast pyrolysis technology.¹⁸³ Another recent review on pyrolysis was written by Mohan et al.¹⁸⁴ A summary of the developments on direct liquefaction of biomass from 1983 to 1990 by the Working Group of the International Energy Agency, Bioenergy activity on direct liquefaction of biomass is presented elsewhere.¹⁸² A number of fast pyrolysis technologies have been commercialized by Ensyn Technologies (six circulating fluidized bed plants, largest is 50 t/day), Dynamotive (10 t/day fluidized bed process, and currently building a 100 t/day

Table 11. Key Fast Pyrolysis Design Features^a

Pretreatment	
particle size	small particles needed; expensive
feed drying	essential to ~10%
washing and additives	for chemical production
Reactor	
heat supply	high heat transfer rate needed
heat transfer	gas–solid and/or solid–solid
heating rates	wood conductivity limits heating rate
reaction temperature	500 °C maximizes liquids from wood
reactor configuration	many configurations have been developed
Product Conditioning and Collection	
vapor residence time	critical for chemicals, less for fuels
secondary cracking	reduces yields
char separation	difficult from vapor or liquid
ash separation	more difficult than char separation
liquids collection	difficult; quench and ep seem best

^a Adapted from Bridgewater and Peacocke.¹⁸³

plant), BTG (rotary cone reactor 5 t/day, wants to build a 50 t/day plant), Fortum (12 t/day pilot plant), and Bioenergy Partners (15 t/day pilot plant, designed 100 t/day plant).¹⁸⁵

Table 11 shows the key fast pyrolysis design parameters. These essential parameters include¹⁸³

(1) A very high heating and heat transfer rate that requires a finely ground biomass feed.

(2) Carefully controlled temperatures around 450–550 °C

(3) Rapid cooling of the pyrolysis vapors (residence time of less than 1 s).

Table 12. Typical Properties of Wood Pyrolysis Bio-Oil, Liquefaction Bio-Oil, and Heavy Fuel Oil^a

property	pyrolysis oil	liquefaction oil	heavy fuel oil
moisture content, wt %	15–30	5.1	0.1
pH	2.5		
specific gravity	1.2	1.1	0.94
elemental composition, wt %			
carbon	54–58	73	85
hydrogen	5.5–7.0	8	11
oxygen	35–40	16	1.0
nitrogen	0–0.2		0.3
ash	0–0.2		0.1
higher heating value, MJ/kg	16–19	34	40
viscosity (50°C), cP	40–100	15000 (at 61°C)	180
solids, wt %	0.2–1		1
distillation residue, wt %	up to 50		1

^a Adapted from Czernik and Bridgewater¹⁸⁵ and Elliot and Schiefelbein.³⁴⁶

Table 12 lists the properties of wood-derived fast pyrolysis oils, liquefaction oils, and diesel fuel. Pyrolysis-derived oils have a higher oxygen content, moisture content, and lower heating value (17 MJ/kg) than conventional fuel oil (43 MJ/kg). Liquefaction oils have higher heating content, lower oxygen content, and lower moisture content than fast pyrolysis oils. Fast pyrolysis bio-oils also are acidic, having a pH of about 2.5. The bio-oils are chemically unstable, undergoing various reactions with time and temperature.

A typical fast pyrolysis system is shown in Figure 15. First, the biomass needs to be dried, which can be done with low-grade process heat such as the outlet flu gas. The biomass particles must then be ground so that they have the optimal heat transfer properties. Grinding specification are less than

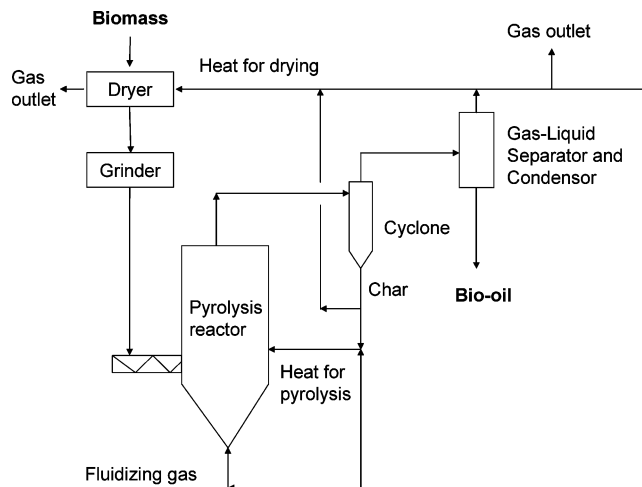
**Figure 15.** Fast pyrolysis reactor system adapted from Bridgewater and Peacocke.¹⁸³

0.2 mm for rotating cone reactors, 2 mm for fluid bed, and 6 mm for circulating or transported fluid beds. The cost of grinding increases when smaller particles are desired. Overviews on drying and grinding of biomass are given elsewhere.^{2,186} At the heart of a fast pyrolysis process is the reactor. Most research has focused on the reactor even though its cost is only 10–15% of the capital cost of the entire plant.

Four main reactor technologies are currently available for commercialization including (1) fluidized beds, (2) circulating fluid beds, (3) ablative pyrolyzer, both cyclonic and plate type, and (4) vacuum pyrolyzer.¹⁸⁷ However, the two more popular configurations are fluidized bed and circulating fluidized bed reactors. A fast pyrolysis reactor must have very high heating and heat transfer rates, moderate and carefully controlled temperature, and rapid cooling or quenching of the pyrolysis vapors.¹⁸³

Fluid beds or bubbling fluid bed, as opposed to circulating fluid bed have the advantages of good temperature control, very efficient heat transfer, short residence times for vapors, and being technologically feasible. The residence time is controlled by the fluidizing gas flow rate, and is higher for char than for vapors. It is necessary to use shallow bed depths and/or a high gas flow rate to achieve short volatiles residence times.¹⁸⁷ The high gas-to-biomass fed ratio results in a lowering of the thermal efficiency (which is typically 60–70%, see Section 6.6). The control of temperature and concentration gradients in fluid bed reactors requires special design methods due to the low bed height-to-diameter ratio. Small particle sizes of less than 2–3 mm are needed for this reactor. Reactor heating can be accomplished by hot walls, hot tubes, hot gas injection, and hot sand recycling. The products from this reactor have a low concentration of char, since char is rapidly removed from the reactor. A high-quality bio-oil is produced in this reactor.

Circulating fluid beds and transported beds are similar to fluidized beds except that the char residence time is almost the same as the vapor and gas residence time.¹⁸⁷ The hydrodynamics of circulating fluid beds are complex; however, they can still be used for very high throughputs. Process heat is supplied by recirculation of heated sand. The rotating cone reactor is similar to the circulating fluid bed, except that the sand and biomass are transported by centrifugal forces of the rotating cone.

Ablative pyrolysis relies on the heat transfer from a hot surface, such as the reactor wall, to the solid biomass

particle.¹⁸⁷ Increasing the pressure of the reactor increases the heating rate, by pushing the biomass particle onto the hot surface with a greater force. The heat moves through the biomass particle in a single direction. A residual oil film forms and provides lubrication for successive biomass particle. The oil film also evaporates forming pyrolysis vapors. A reactor wall temperature less than 600 °C is required, and a high relative motion between particle and reactor wall is also desirable. An advantage of this type of reactor is that large particles can be used since reaction rates are not limited by heat transfer. However, the process is limited by the rate of heat supply to the reactor rather than the rate of heat absorption by the pyrolyzing biomass. Surface area of the reactor is a key design variable. In comparison with other reactors large amounts of tar are produced in ablative reactors.

Vacuum pyrolysis has the advantage of short residence time for volatiles, with longer residence time for the solids.¹⁸⁷ The disadvantages of vacuum pyrolysis are that poor heat and mass transfer rates occur.

Following the pyrolysis reactor, a cyclone separates the solid char products.¹⁸³ It is desirable to collect as much char as possible, since char not removed will collect in the liquid products causing further downstream processing problems. Char can also act as a vapor cracking catalyst degrading the pyrolysis products. Char separation is difficult, and hot vapor filters, which are currently being developed, also can be used with cyclones. The char is burned to provide process heat for pyrolysis and biomass drying. The liquid–gas products are then separated. The liquid products must be quickly condensed. Otherwise, they will react and crack at high temperatures. Production of chemicals and food additives requires vapor residence times of a few hundred milliseconds. Longer vapor residence times of around 2 s can be used if bio-oils are to be used as a fuel. Short vapor residence times are an engineering difficulty, and novel techniques such as quenching and electrostatic precipitation have been used. However, careful design and temperature control are needed to avoid blockage from differential condensation of the heavy products.

5.2. Bio-Oils by Liquefaction

Liquefaction of biomass produces a water-insoluble bio-oil by treatments at high pressure (50–200 atm) and low temperature (250–450 °C). The overall objective of biomass liquefaction is to control the reaction rate and reaction mechanisms, using pressure, gases, and catalysts, to produce a premium liquid oil. The reactor feeds consist of a slurry containing the solid biomass feed in a solvent, reducing gases such as H₂ or CO, and/or a catalyst. The bio-oil produced by liquefaction has a lower oxygen content and therefore higher energy content than pyrolysis-derived oils (Table 12). There are a variety of liquefaction processes including hydrothermal processing (water or aqueous solvent), hydro-pyrolysis (no carrier liquid solvent), and solvolysis (reactive liquid solvent). The high-pressure processing that occurs with liquefaction causes technical difficulties and an increased capital cost. A review of previous biomass liquefaction research from 1920 to 1980 is presented by Moffatt and Overend.¹⁸⁸

A number of catalysts have been used for liquefaction including alkali (from the alkaline ash components in wood, alkaline oxides, carbonates, and bicarbonate), metals (such as zinc, copper and nickel, formate, iodine, cobalt sulfide,

zinc chloride, ferric hydroxide), and Ni and Ru heterogeneous catalysts (which aid in preferential hydrogenation). A number of different solvents have been used for liquefaction including water (the most common solvent),¹⁸⁸ creosote oil,¹⁸⁹ ethylene glycol,¹⁸⁹ methanol,¹⁸⁸ and recycled bio-oil.¹⁸⁸ Water is one of the most attractive due to its low cost. Aqueous-phase liquefaction do not require a drying step and therefore are ideal for processing wet biomass. Recycling the product oil into the reactor has been shown to increase the product selectivity.¹⁸⁸ Hydro-pyrolysis involves liquefaction of biomass with high-pressure H₂ and a heterogeneous catalyst.¹⁸⁸ Solvolysis is a related high-pressure process where liquids such as creosote oil, ethylene glycol, simple alcohols, and phenol are used as solvents.

A liquefaction process entitled hydrothermal upgrading (HTU) was originally developed by Shell and is currently being commercialized by Shell, BTG, TNO-MEP, Biofuel and Stork Engineers and Contractors. This liquefaction process takes place at 300–350 °C, 120–180 bar, and 5–20 min residence times.¹⁶ A typical product consists of 45 wt % biocrude, 25 wt % gas (mostly CO₂), 20% H₂O, and 10 wt % dissolved organics, acetic acid, methanol. According to Goudriaan et al., the advantages of liquefaction process are the high thermal efficiencies for conversion of wet feedstocks, good product quality/flexibility, the potential for upscaling, and rapid rate of commercial development. However, the HTU bio-oils do have a high viscosity, and it is questionable if this technology could indeed be rapidly commercialized.

5.3. Bio-Oil Chemistry

Bio-oils are usually a dark brown, free-flowing liquid that has a distinctive odor. During bio-oil production, a large number of reactions occur, including hydrolysis, dehydration, isomerization, dehydrogenation, aromatization, retro-condensation, and coking. The exact composition of the bio-oil is dependent on¹⁹⁰

- (1) The feedstock (including dirt and moisture content)
- (2) Organic nitrogen or protein content of the feedstock
- (3) Heat transfer rate and final char temperature during pyrolysis
- (4) Extent of vapor dilution in the reactor
- (5) Time and temperature of vapors in the reactor
- (6) Time and temperature of vapors in heated lines from the reactor to the quench zone
- (7) If the vapors pass through the accumulated char during filtration
- (8) Efficiency of the char removal system
- (9) Efficiency of the condensation equipment to recover the volatile components from the noncondensable gas stream
- (10) If the condensates have been filtered to remove suspended char fines
- (11) Water content of the feedstock
- (12) Extent of contamination of the bio-oil during storage by leaching of containers
- (13) Exposure of air during storage
- (14) Length of storage time
- (15) Storage temperature

Milne et al. have summarized the chemical composition of bio-oils, which we report in Figure 16.¹⁹¹ Milne's analysis is consistent with a more recent study by Branca et al.¹⁹² More than 400 organic compounds have been found in bio-oils. Figure 16 shows the range of compositions that can be found in bio-oils. The compounds in the bio-oil can vary by

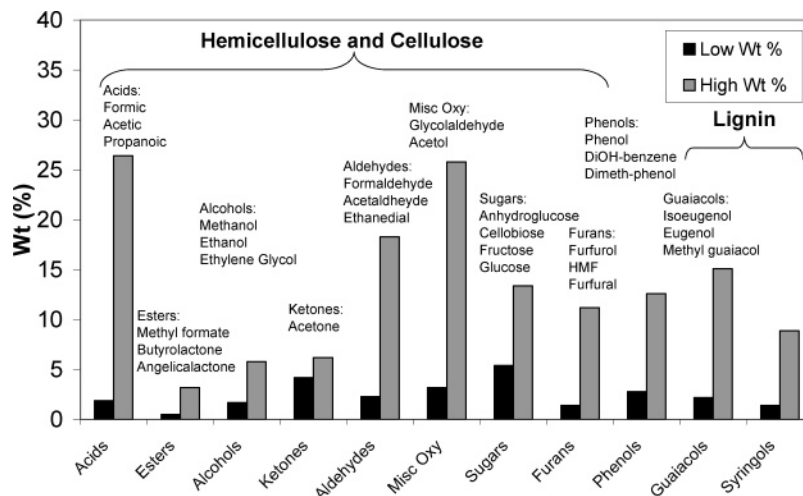

Figure 16. Chemical composition of bio-oils according to Milne et al.¹⁹¹ The graph also shows the most abundant molecules of each of the components and the biomass fraction from which the components were derived.

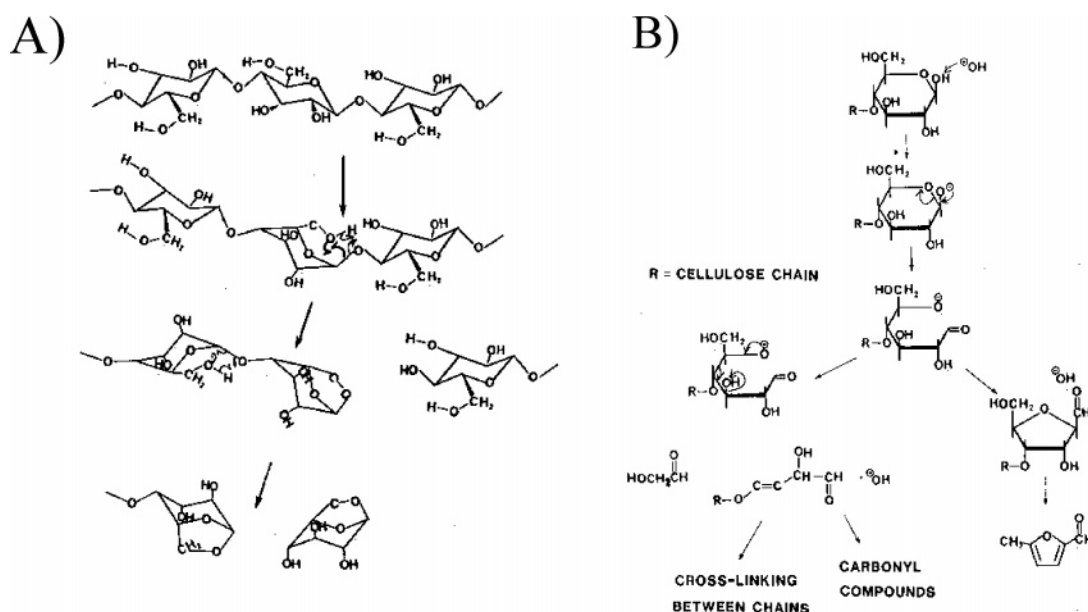

Figure 17. Mechanism of cellulose degradation without alkali metals (A) and glucose degradation with alkali-metal-catalyzed or glycoside rupture pathways (B) from Evans and Milne.⁵³ (Reprinted from ref 53 with permission. Copyright 1987 American Chemical Society.)

more than an order of magnitude. The bio-oil contains acids (some of the major components include acetic, propanoic), esters (methyl formate, butyrolactone, angelica lactone), alcohols (methanol, ethylene glycol, ethanol), ketones (acetone), aldehydes (acetaldehyde, formaldehyde, ethanedial), miscellaneous oxygenates (glycolaldehyde, acetol), sugars (1,6-anhydroglucose, acetol), furans (furfural, HMF, furfural), phenols (phenol, DiOH benzene, methyl phenol, dimethyl phenol), guaiacols (isoeugenol, eugenol, 4-methyl guaiacol), and syringols (2,6-DiOMe phenol, syringaldehyde, propyl syringol). The multicomponent mixtures are derived primarily from depolymerization and fragmentation reactions of the three key building blocks of lignocellulose: cellulose, hemicellulose, and lignin. The guaiacols and syringols are formed from the lignin fraction, whereas the miscellaneous oxygenates, sugars, and furans form from the cellulose and hemicellulose biomass fraction. The esters, acids, alcohols, ketones, and aldehydes probably form from decomposition of the miscellaneous oxygenates, sugars, and furans.

Pyrolysis of pure cellulose produces mainly levoglucosan in yields of up to 60%.¹⁹³ Levoglucosan probably forms by

a mechanism involving intramolecular condensation and sequential depolymerization of the glycosidic units as shown in Figure 17A.⁵³ Inorganic impurities of the biomass play a key role in terms of the bio-oil product selectivity. The cellulose degree of polymerization and crystallinity do have some influence on the bio-oil composition, but in general these effects are not as large as the effect of inorganic impurities. For example, the composition of levoglucosan is low in the pyrolysis of most biomass even though the cellulose concentrations are greater than 50%. The addition of minor amounts of alkali (such as K, Li, Ca) to cellulose shifts the mechanism (and the final product selectivity) so that glycolaldehyde is the stable reaction intermediate instead of levoglucosan.^{53,65}

The exact mechanism by which trace quantities of salts and metal ions influence the pyrolysis course is not known, although Evans and Milne have suggested a probable mechanism as shown in Figure 17B. The presence of alkali salts has a greater influence on the reaction mechanism than temperature. Alkali cations also increase the rate of reaction during pyrolysis.¹⁹⁴ Lignocellulose can be pretreated to

Table 13. Inorganic Compounds in Bio-Oils and Char^a

feedstock	oak		southern pine		switchgrass		hybrid poplar		
	material	bio-oil	char in oil (>2 μm)	bio-oil	char in oil (>2 μm)	char in oil (>10 μm)	char in oil (2–10 μm)	bio-oil	bio-oil
char removal method	cyclone	cyclone + oil filter (2 μm)	cyclone	cyclone + oil filter (2 μm)	cyclone + oil filter (10 μm)	cyclone + oil filter (2 μm)	hot-gas filter	hot-gas filter	
char %	0.74		0.13						
ash %	0.09		0.03		15.3	<0.05	0.01	0.007	
impurities (ppm)									
Ca	160	4580	160	8100	7100	2.2	2.2	1	
Si	112		93	3452		1.4			
K	55	1300	10	667	8500	175	2.7	1	
Fe	86		47	1772					
Al	55		41				2.6	0.3	
Na	2	60	<0.1	372	690	17	7.2	0.9	
S	<60		<50	349					
P	<50		<50	550	3600	3.6			
Mg	<55		<45	903					0.7
Ni	<22		<20	288					
Cr	<17		<17	524					
Zn	28		14	258					
Li	25		7	110					
Ti	17		5	130			<0.2		
Mn	15		6	353			0.063	0.04	
Cu				39					
Ba	<3		<2	170					
V							0.002	<0.01	
Cl					10600	1600	7.9	11	

^a Adapted from Diebold.¹⁹⁰

remove alkali salts by ion-exchange prior to pyrolysis. Pyrolysis of wood and cellulose after alkali removal leads to high yields of levoglucosan (27% from wood, 45% from cellulose).¹⁹⁵ The pyrolysis behavior of sugars is different than that of cellulose even though they have similar chemical structures.¹⁹⁶ Hydroxyacetaldehyde may be a major product from glycosidic rupture pathway, and sugars are known to undergo retro-aldol condensation in sub- and supercritical water. Cellulose pyrolysis yields more levoglucosan, fewer molecular weight oxygenated compounds (such as glycolaldehyde and acetaldehyde), and fewer furans (such as furfural and HMF) than does glucose pyrolysis. This difference in reactivity could be because carbohydrates have acyclic or open ring forms, whereas cellulose is in a fixed polymer structure.

Evans et al. studied the pyrolysis of lignin with molecular-beam mass spectrometry³⁰ and observed that lignins preferentially form their precursor monomers. The lignin fraction undergoes primary pyrolysis by structurally controlled depolymerization. Lignin components that appear in bio-oils include coniferyl alcohol, sinapyl alcohol, isoeugenol, vanillin, vinylguaiacol, methyl guaiacol, guaiacol, and catechol.⁵³ Coniferyl and sinapyl alcohol are the first products to form from lignin, while the lower molecular weight products (guaiacol and catechol) are formed later. The primary pyrolytic lignin content is mostly oligomeric and monomer content is small.

Bio-oils contain inorganic compounds as shown in Table 13. During bio-oil storage, the inorganic compounds of biomass catalyze polymerization and other reactions in the bio-oil leading to a viscosity increase. Leaching of processing and storage equipment by the acidic bio-oils can also cause inorganic contaminants in the bio-oils. Therefore, care must be taken to properly design equipment. In contrast to coal and crude oil, biomass contains low amounts of sulfur, and most of the sulfur becomes concentrated in the char (Table 13).

Cellulose pyrolysis kinetics have been studied by measuring the weight loss as a function of temperature in a thermogravimetric analyzer (TGA). The reaction is endothermic, and the weight loss can be fit with a first-order rate law and an activation energy of 240 kJ/mol.^{65,197} Cellulose derived from different manufacturers have shown a large difference in the kinetics.¹⁹⁷ The kinetics of pyrolysis of lignin and xylan cannot be described by a first-order reaction model.¹⁹⁸ However, the pyrolysis kinetics of lignocellulosic material can be modeled with three first-order reactions of three pseudo-components where the models correspond to the fraction of hemicellulose, cellulose, and lignin.¹⁹⁸

A number of different reaction models have been proposed for cellulose decomposition including the Broido-Shafizadeh,^{200,201} Waterloo,²⁰² Diebold,²⁰³ Várhegyi-Antal,⁶⁵ and Wooten-Seeman-Hajaligol model.¹⁹⁹ The majority of these models have cellulose being converted into a more active form of cellulose, which is the rate-limiting step. Figure 18 shows the Wooten-Seeman-Hajaligol model where the first

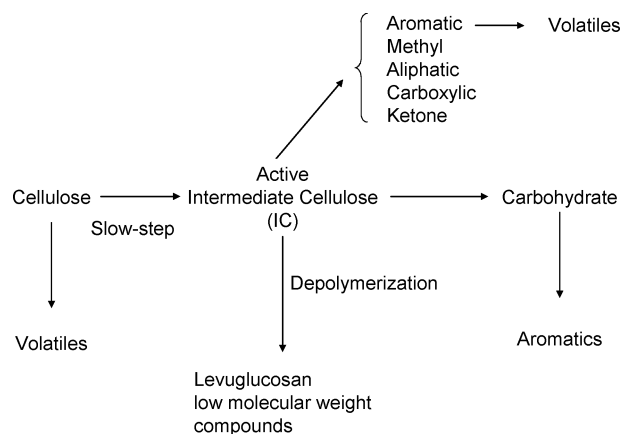

Figure 18. Mechanism for cellulose decomposition adapted from Wooten, Seeman and Hajaligo.¹⁹⁹

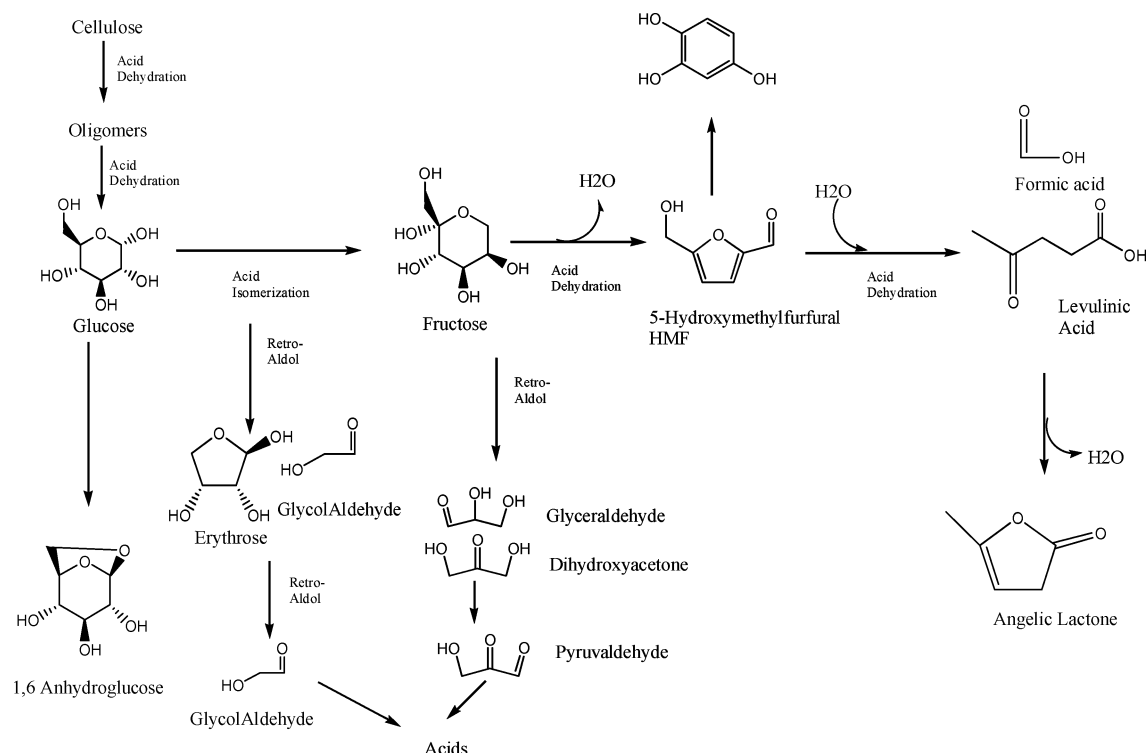

Figure 19. Cellulose decomposition pathways in supercritical water.

step is formation of an active intermediate form of cellulose (identified by NMR) and then the cellulose decomposed into levoglucosan, carbohydrates, or other compounds containing methyl, aromatics, ketones, or other functional groups.

Insight into the pyrolysis mechanism can be learned from studying the chemistry for the decomposition pathways of cellulose and glucose in aqueous water, which is shown in Figure 19.^{204–206} Glucose undergoes isomerization to form fructose, which then can undergo dehydration to form HMF. The mechanism of HMF formation is reviewed by Antal and co-workers.²⁰⁷ Further dehydration of HMF yields a 1:1 mixture of levulinic and formic acids. Angelic lactone forms by dehydration of levulinic acid. Retro-aldol reactions produce glycolaldehyde, dihydroxyacetone, glycolaldehyde, and erythrose from fructose and glucose. These intermediates react further to form pyruvaldehyde, glycolaldehyde, and acids. Glucose can also form 1,6-anhydroglucose by dehydration. Decomposition of HMF in pyrolysis chars has been shown to form 1,2,4-benzenetriol. Hemicellulose undergoes analogous reaction pathways to those shown in Figure 19.

5.4. Bio-Oil Problems

The most significant problems of bio-oils as a fuel are poor volatility, high viscosity, coking, corrosiveness, and cold flow problems.¹⁸⁵ These problems have limited the applications of bio-oils. No quality standards have yet been made for bio-oil production. The main concerns for burning bio-oils in diesel engines have to do with difficult ignition (due to low heating value and high water content), corrosiveness (acids), and coking (thermally unstable components). Bio-oils must be upgraded or blended to be used in diesel engines (Section 6.0).

Bio-oils polymerize and condense with time, and this process is accelerated by increasing temperature, oxygen exposure, and UV light exposure. These reactions result in increasing viscosity and phase separation in the bio-oil.

Diebold has written a review on the chemical and physical mechanisms of the storage stability of fast pyrolysis bio-oils.¹⁹⁰ According to Diebold, the probable reactions that occur within bio-oil that cause degradation are

- (1) Organic acids with alcohols forming esters and water
- (2) Organic acids with olefins forming esters
- (3) Aldehydes and water to form hydrates
- (4) Aldehydes and alcohols forming hemiacetals or acetals and water
- (5) Aldehydes forming oligomers and resins
- (6) Aldehydes and phenols forming resins and water
- (7) Aldehydes and proteins forming oligomers
- (8) Organic sulfur forming oligomers
- (9) Unsaturated compounds forming polyolefins
- (10) Air oxidation that forms acids and reactive peroxides (which catalyze polymerization of unsaturated compounds)

Reactions 1–4 form products in thermodynamic equilibrium where a change in temperature or concentration will cause a reversible reaction. Reactions 5–10 form resins or polyolefins that are probably irreversibly produced.

5.5. Economics and Thermal Efficiencies of Bio-Oil Production Methods

The major challenges for producing bio-oils are¹⁸⁵

- (1) Cost of bio-oil is 10–100% more than fossil fuel (based on the cost of fossil fuels in 2004).
- (2) Availability: there are limited supplies for testing and development of applications.
- (3) There are a lack of standards and inconsistent quality.
- (4) Bio-oils are incompatible with conventional fuels.
- (5) Users are unfamiliar with this material.
- (6) Dedicated fuel handling systems are needed.
- (7) Pyrolysis as a technology does not enjoy a good image.

The economics and process thermal energy efficiency for production of liquid transportation fuels have been analyzed by the Working Group of the International Energy Agency

Table 14. Economic and Thermal Efficiency Analysis for Production of Gasoline and Diesel Fuels by Pyrolysis and Liquefaction^a

	atmospheric flash pyrolysis (AFP)		liquefaction in pressurized solvent (LIPS)	
	present	potential	present	potential
Total Capital Requirement (\$U.S. millions)				
primary liquefaction	49.8	26.4	84.2	48.4
crude upgrading	46.6	34.3	26.8	26.0
product finishing	14.5	0.7	15.3	0.7
total	110.9	61.4	126.3	75.1
Production Costs (\$U.S. million/year)				
fixed operating costs	14.48	10.77	14.48	10.03
variable operating costs	25.74	23.67	33.44	33.60
(feedstock costs)	(20.00)	(20.00)	(20.00)	(20.00)
capital charges	12.96	7.17	14.75	8.78
total production cost	53.18	41.61	62.67	52.39
Minimum Selling Price (\$U.S./GJ)				
bio-oil	9.32	6.91	13.44	12.27
refined bio-oil	16.24	12.99	19.54	14.77
Process Thermal Efficiency ($\text{energy}_{\text{liquid products}}/\text{energy}_{\text{feed+inputs}}$)				
primary product from liquefaction	0.61	0.68	0.55	0.48
finished product	0.52	0.53	0.48	0.49
Life Cycle Thermal Efficiency ($\text{energy}_{\text{liquid products}}/\text{energy}_{\text{feed+inputs}}$)				
finished product	0.40	0.40	0.36	0.37

^a Results in 1990 U.S. dollars and assuming a feedstock cost of \$30/wet metric ton (wood chips with 50% moisture content) biomass based on a 1000 dry metric ton/day of biomass feed according Elliott et al.²⁰⁸ Current FOB spot price cost of diesel fuel based on higher heating value is \$11/GJ with oil at \$57/bbl.¹⁴ Life cycle thermal efficiencies are estimated with data from Towler²⁶ for eucalyptus trees which is also reported in Table 1 and assumes that $5.57 \text{ MJ}_{\text{fossil fuel}}/\text{kg}_{\text{wood}}$ and a LHV of $18.1 \text{ MJ}/\text{kg}_{\text{wood}}$.

direct biomass liquefaction activity, and the results are shown in Table 14.²⁰⁸ The assessment was done with liquid fuels from atmospheric flash pyrolysis (AFP) and liquefaction in pressurized solvent (LIPS). Three steps were analyzed including (1) primary liquefaction to a crude oil product, (2) catalytic hydrotreating to upgrade the crude product to a deoxygenated product oil, and (3) refining the deoxygenated product to gasoline and diesel fuel. The refining costs were estimated based on costs for refined oils derived by liquefaction of coal and oil shale and do not represent actual experimental results. The AFP process consists of rapid pyrolysis in a sand bed of wood fibers to vapors and chars developed at University of Waterloo. The LIPS process is based on tests at the Biomass Liquefaction Experimental Facility in which wood chips are mixed with recycled wood-derived oil, sodium carbonate, and syn-gas in an upflow tubular reaction at 350 °C, 20.5 MPa with a 20 min residence time. Catalytic hydrotreating was done to upgrade both of the primary oils in two separate stages: a low-temperature stage (300 °C) followed by a high-temperature stage (350 °C).

The economic analysis is based on a plant capacity of 1000 dry tons/day of biomass, a cost of \$30/metric ton of wood chips (50% moisture content), and a 10% interest rate. As shown in Table 14, the capital cost for primary liquefaction of oils with LIPS is 70–80% higher than for AFP. The capital cost for the catalytic upgrading of the oils from the AFP process is higher than for the LIPS process, since liquefaction-derived oils have a higher oxygen content than do pyrolysis-derived oils. Therefore, the final capital cost for the AFP oils is only 14–22% that for the LIPS process. For both the AFP and LIPS processes the feedstock cost represents only 30–50% of the final production cost.

Cheaper feedstock costs will significantly change the cost of the final product. The minimum selling price of the pyrolysis-derived oils and upgraded products is less than the

liquefaction-derived oils. The cost of producing refined liquid fuels (\$13–20/GJ) is greater than the cost of gasoline and diesel fuel in 2005 (\$11.5/GJ). However, the cost of the bio-oil (\$7–13/GJ) can be less than the current cost of gasoline and diesel fuel. Economic analysis of the Shell HTU liquefaction process have estimated that biocrude product can be produced at \$4.6/GJ if the biomass feedstock can be obtained at zero cost.¹⁶

The process thermal energy efficiency of the primary oil products ranges from 0.61 to 0.68 for the pyrolysis oils to 0.48–0.55 for the liquefaction oils (Table 14). The PTE decreases during catalytic upgrading and refining to 0.48–0.52. It has been claimed that the HTU liquefaction process has an overall PTE of 70–90%.¹⁶ Shell currently has a pilot plant with a claimed 75% thermal efficiency. Bio-oil process thermal efficiencies are higher than liquid fuels derived by biomass-derived syn-gas followed by FTS (0.16–0.43) as shown in Table 9.

Research in bio-oil production has shifted to focus on production of less costly fast pyrolysis oils mainly due to the high capital cost involved for high-pressure liquefaction processes (Table 14). According to Elliott et al., upgrading of the high-pressure liquefaction-derived bio-oils does not appear to have any significant advantage in the upgrading area.¹⁸² However, in the long term liquefaction-derived bio-oils may prove to be more beneficial since they have properties more similar to transportation fuels. It would be desirable to be able to control the chemistry occurring during pyrolysis and liquefaction by addition of catalysts and controlling the reaction parameters. This means that again the fundamental chemistry of the processes involved needs to be better understood, and future research on this subject is required. Most of the fuels currently made from pyrolysis are low value products and require further upgrading; therefore, bio-oil upgrading appears to be a promising research area.

6.0. Bio-Oil Upgrading

Bio-oils must be upgraded if they are to be used as a replacement for diesel and gasoline fuels. As was said in the previous section, the properties that most negatively affect bio-oil fuel quality are low heating value, incompatibility with conventional fuels, solids contents, high viscosity, incomplete volatility, and chemical instability. Bio-oils can be upgraded into a liquid transportation fuel by three different routes: (1) hydrodeoxygenation with typical hydrotreating catalysts (sulfided CoMo or NiMo) (Section 6.1), (2) zeolite upgrading (Section 6.2), or (3) forming emulsions with the diesel fuel (Section 6.3). Alternatively, bio-oils and chars can be converted into H₂ or syn-gas by steam-reforming (Sections 6.4–6.5).

6.1. Hydrodeoxygenation

Hydrodeoxygenation of bio-oils involves treating bio-oils at moderate temperatures (300–600 °C) with high-pressure H₂ in the presence of heterogeneous catalysts. Reviews on hydrodeoxygenation have been written by Furmisky²⁰⁹ and Elliott et al.¹⁸² Most hydrodeoxygenation work has focused on sulfided CoMo and NiMo-based catalysts, which are industrial hydrotreating catalysts for removal of sulfur, nitrogen, and oxygen from petrochemical feedstocks. Pt/SiO₂–Al₂O₃,²¹⁰ vanadium nitride,²¹¹ and Ru have also been used for hydrodeoxygenation. During hydrodeoxygenation, the oxygen in the bio-oil reacts with H₂ to form water and saturated C–C bonds. It is desirable to avoid hydrogenation of aromatics in the bio-oils, since this would decrease the octane number and increase H₂ consumption. The energy content of the fuel is significantly increased, and the stability of the fuel increases during hydrodeoxygenation as shown in Table 15. Partial deoxygenation results in an increase in

Table 15. Properties of Bio-Oils and Upgraded Bio-Oils^a

	high-pressure liquefaction	flash pyrolysis	hydro- deoxygenated bio-oils
elemental analysis			
carbon (wt %)	72.6	43.5	85.3–89.2
hydrogen (wt %)	8.0	7.3	10.5–14.1
oxygen (wt %)	16.3	49.2	0.0–0.7
sulfur (wt %)	<45	29.0	0.005
H/C atom ratio (dry)	1.21	1.23	1.40–1.97
density (g/mL)	1.15	24.8	0.796–0.926
moisture (wt %)	5.1	24.8	.001–0.008
higher heating value (MJ/kg)	35.7	22.6	42.3–45.3
viscosity (cP)	15,000 (61 °C)	59 (40 °C)	1.0–4.6 (23 °C)
aromatic/aliphatic carbon			38/62–22/78
research octane number (RON)			77
distillation range (wt %)			
IBP–225 °C	8	44	97–36
225–350 °C	32	coked	0–41

^a From Elliott and Schiefelbein.³⁴⁶

oil viscosity, and deoxygenation to less than 5 wt % oxygen is required to a low viscosity like that required for fuel applications.²¹² The disadvantage of hydrotreating is that it requires high-pressure H₂, which in an integrated biorefinery could be produced from the biomass (see Sections 4.1, 6.4, 8.3, and 8.4 for H₂ production pathways).

Elliott and co-workers developed a two-step hydrotreating process for upgrading of bio-oils derived from pyrolysis.^{212–214} The first step involves a low temperature (270 °C, 136 atm) catalytic treatment that hydrogenates the thermally unstable bio-oil compounds, which would otherwise thermally decompose forming coke and plugging the reactor. The second step involves catalytic hydrogenation at higher temperature (400 °C, 136 atm). The same catalyst, a sulfided Co–Mo/Al₂O₃ or sulfided Ni–Mo/Al₂O₃, is used for both steps. This process can produce yields of 0.4 L_{refined-oil}/L_{bio-oil-feed} with the refined oil containing less than 1 wt % oxygen. During this process, 20–30% of the carbon in the bio-oil is converted into gas-phase carbon, decreasing the overall yield. Catalyst stability and gum formation in the lines were identified as major process uncertainties. The properties of hydrotreated and untreated bio-oils are shown in Table 15. Upgraded bio-oils have a research octane number (RON) of 72, and an aromatic/aliphatic carbon ratio of 38/62–22/78. The octane number is lower than gasoline, and while aromatics do have a higher octane number they cause air pollution problems.

Delmon and co-workers studied the hydrodeoxygenation of model bio-oil compounds with sulfphided CoMo and NiMo catalysts to elucidate the main reaction pathways, the influence of the important reaction parameters, and the possible catalytic poisons.^{215–219} The model feedstock was a mixture of 4-methylacetophenone, ethyldecanoate, and guaiacol as shown in Figure 20. The ketone group is easily and selectively hydrogenated into a methylene group above 200 °C.²¹⁷ Carboxylic groups are also hydrogenated under hydrodeoxygenation conditions, but a parallel decarboxylation pathway also occurs at comparable rates.²¹⁷ Carboxylic groups and guaiacyl groups are not as reactive as ketone groups, and temperatures greater than 300 °C are required for their conversion. Guaiacol was hydrogenated into catechol and then to phenol. Guaiacol was the compound that caused catalyst deactivation due to coking reactions.

The acidity of the catalytic support does not change the hydrogenation rate of the 4-methylacetophenone, but increasing the support acidity does increase rates of decarboxylation and hydrogenation of ethyldecanoate and coke formation from guaiacol. Carbon, which has low acidity, is a good catalytic support for hydrodeoxygenation. It is necessary to add sulfur (dimethyl disulfide) to the feed to keep the catalyst from deactivating, and the catalytic activity is dependent upon the H₂S partial pressure. Water decreased the catalytic activity to one-third the initial activity.²¹⁹ Future work in hydrodeoxygenation could focus on developing non-sulfur-based catalysts for hydrodeoxygenation.

6.2. Zeolite Upgrading of Bio-Oils

Zeolites, and in general molecular sieve inorganic materials, are the most widely used industrial catalyst used for oil refining, petrochemistry, and production of fine and specialty chemicals.^{220–222} Zeolites are crystalline microporous materials with well-defined pore structures on the order of 5–12 Å.²²⁰ Zeolites contain active sites, usually acid sites, which can be generated in the zeolite framework. The strength and concentration of the active sites can be tailored for particular applications. Zeolites have very high surface areas and adsorption capacity. Their adsorption properties can be controlled, and they can be varied from hydrophobic to hydrophilic materials.

Bio-oils can be upgraded using zeolite catalysts to reduce oxygen content and improve thermal stability. Temperatures

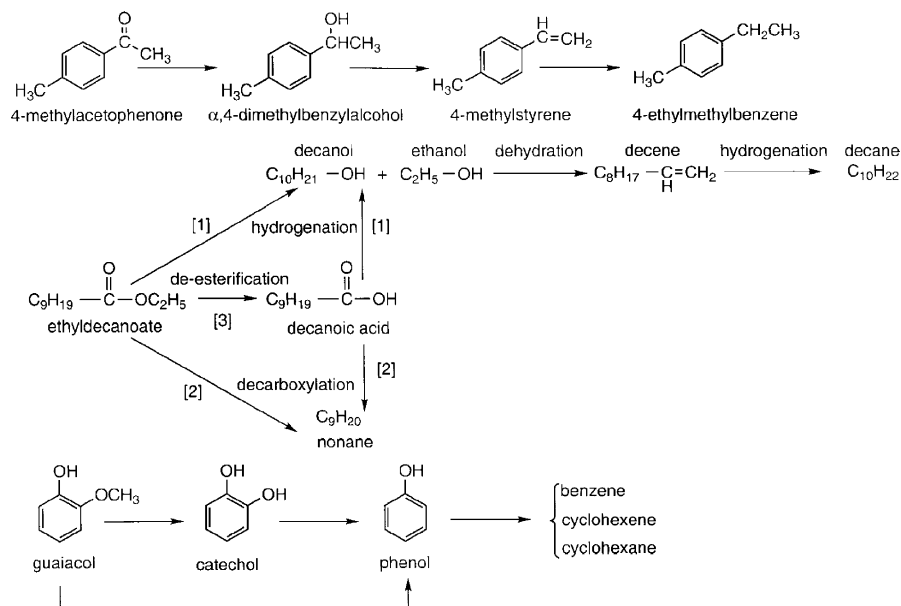

Figure 20. Hydrodeoxygenation pathways of 4-methylacetophenone, ethyl decanoate, and guaiacol from Ferrari et al.²¹⁵ (Reprinted from ref 215 with permission. Copyright 2001 Elsevier.)

Table 16. Comparison of Different Catalysts for Zeolite Upgrading of Wood-Derived Fast-Pyrolysis Bio-oils^a

	HZSM-5	silica–alumina (SiO ₂ –Al ₂ O ₃ ratio 0.14)	SAPO-5	SAPO-11	MgAPO-36
catalyst properties					
pore size (nm)	0.54	3.15	0.80	0.56	0.75
BET surface area (m ² /g)	329	321	330	205	196
acid area (cm ² /g) ^b	224.9		125.5	76.0	15.5
product yields (wt % of feed)					
organic liquid product	33.6	24.9	22.2	19.9	16.3
gas		6.1	10.3	12.2	10.1
coke + char ^c	20.5–30.2	40	30.0	25.5	38.7
tar ^d	0–4.1		9.5	11.9	10.1
aqueous fraction		25.0	24.2	26.3	23.1
composition organic liquid product (wt %)					
total hydrocarbons	86.7	45.6	51.0	56.8	51.6
aromatics	85.9 ^e	2.1	27.5	29.1	26.7
aliphatics	18.6	43.5	23.5	24.4	23.4

^a From Bakhshi and co-workers.^{224–226} Reaction temperature 370 °C. ^b Acid area is measured by ammonia TPD and represents Bronsted plus Lewis acid sites. ^c Coke is defined as organics that could only be removed from catalyst by calcinations. Char is defined as organics deposited in the reactor due to thermal decomposition, and these compounds were not on the catalyst. ^d Tar are the heavy oils deposited on the catalysts that were only removed with a hexane/acetone wash. ^e Toluenes and xylenes are the most common aromatics for HZSM-5, whereas benzene is the most common aromatic for SAPO and MgAPO catalysts.

of 350–500 °C, atmospheric pressure and gas hourly space velocities of around 2 are used for zeolite upgrade. The products from this reaction include hydrocarbons (aromatic, aliphatic), water-soluble organics, water, oil-soluble organics, gases (CO₂, CO, light alkanes), and coke. During this process a number of reactions occur including dehydration, cracking, polymerization, deoxygenation, and aromatization. Similar reactions using zeolite catalysts also occur with other feedstocks including methanol (Section 4.2), sugar monomers (Section 8.2), lignin (Section 9), and vegetable oils (Section 10). The advantages of using a zeolite catalyst are that no H₂ is required, atmospheric processing reduces operating cost, and the temperatures are similar to those for bio-oil production. According to Bridgwater, this offers significant processing and economic advantages over hydrotreating.²²³ However, poor hydrocarbon yields and high yields of coke generally occur under reaction conditions limiting the usefulness of zeolite upgrading.

Table 16 shows the results for zeolite upgrading of wood-derived fast-pyrolysis bio-oils by Bakhshi and co-workers

with different catalysts.^{224–226} Between 30 and 40 wt % of the bio-oil was deposited on the catalyst as coke or in the reactor as char. The ZSM-5 catalyst produced the highest amount (34 wt % of feed) of liquid organic products of any catalyst tested. The products in the organic carbon were mostly aromatics for ZSM-5 and aliphatics for SiO₂–Al₂O₃. Gaseous products include CO₂, CO, light alkanes, and light olefins. Bio-oils are thermally unstable and thermal cracking reactions occur during zeolite upgrading. Bakhshi and co-workers developed a two reactor process, where only thermal reactions occur in the first empty reactor, and catalytic reactions occur in the second reactor that contains the catalyst.²²⁷ The advantage of the two reactor system is that it improved catalyst life by reducing the amount of coke deposited on the catalyst.

The transformation of model bio-oil compounds, including alcohols, phenols, aldehydes, ketones, acids, and mixtures, have been studied over HZSM-5 catalysts, and the major pathways are shown in Figure 21.^{228–230} Alcohols were converted into olefins at temperatures around 200 °C, then

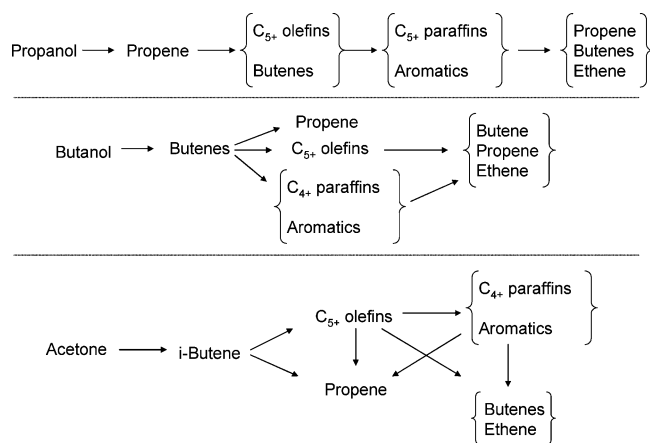

Figure 21. Products from zeolite upgrading (HZSM-5) of model biomass compounds including propanol, butanol, and acetone adapted from Gayubo et al.^{228,229}

to higher olefins at 250 °C, followed by paraffins and a small proportion of aromatics at 350 °C (Figure 21).²²⁸ Phenol has a low reactivity on HZSM-5 and only produces small amounts of propylene and butanes. 2-Methoxyphenol also has a low reactivity to hydrocarbons and thermally decomposes generating coke. Acetaldehyde had a low reactivity on ZSM-5 catalysts, and it also underwent thermal decomposition leading to coking problems.²²⁹ Acetone, which is less reactive than alcohols, first is dehydrated to *i*-butene at 250 °C (Figure 21) and then converts into C₅₊ olefins at temperatures above 350 °C. These olefins are then converted into C₅₊ paraffins, aromatics, and light alkenes. Acetic acid is first converted to acetone, which is converted into acetone products. Products from zeolite upgrading of acetic acid and acetone had considerably more coke than did products from alcohol feedstocks. Thus, different molecules in the bio-oils have a significant difference in reactivity and coke formation rates. Gayubo et al. recommended that the oil fractions that lead to thermal coking (such as aldehydes, oxyphenols, and furfurals) be removed from the bio-oil prior to zeolite upgrading. Bio-oils can be separated by fractionation using mainly water and produce an oil layer (with mostly lignin-derived components) and an aqueous carbon containing layer.¹⁸⁵ The patent literature lists processes for the selective removal of phenolic compounds from bio-oils by liquid–liquid extraction, where the phenolic compounds are then used to make phenol-formaldehyde resins.^{231,232}

6.3. Bio-Oil Mixtures

Bio-oils from fast pyrolysis are not soluble in petroleum-derived fuel due to their high water content; however, blending of diesel with bio-oils can be accomplished using surfactants.^{233–235} Bio-oil emulsions have promising ignition characteristics but also have a high cost due to surfactant addition and a high energy cost for emulsification. Higher corrosion levels occur in engine applications with the bio-oil–diesel emulsions.²³⁵ Ikura et al. produced emulsions of bio-oil obtained by fast pyrolysis of hardwood (Ensyn Technologies), from 10 to 30 wt % bio-oil using a mixture of Hypermer B246SF, Hypermer 2234 surfactant, and No. 2 diesel fuel.²³³ The cetane number, which is a measure of the diesel fuel quality with higher cetane numbers being better for engine use, decreased from 46, 43, 38, to 34 as the bio-oil concentration increased from 0, 10, 20, to 30 wt %, respectively. The corrosivity of the emulsions was about

half that of the bio-oil, and the viscosity of the emulsion increased as the fraction of the bio-oil increased. The surfactant production costs for a fuel with zero stratification emulsions are reported to be 2.6, 3.4, and 4.1 ¢/L for 10, 20, and 30 wt % bio-oil emulsions, respectively.²³³ Fuels with a higher weight percent of bio-oils (up to 75% bio-oil) were prepared, characterized, and tested by Chiaramonti et al.^{234,235} Mixtures of methanol and cetane enhancers can be used to improve the combustion characteristics of bio-oils. Suppes reported a cetane number of bio-oil as 27;¹⁸⁵ however, blending bio-oils with a 4% cetane enhancer (tetraethyleneglycol dinitrate), 24% methanol and 72% bio-oils showed a performance similar to that of diesel fuel in terms of ignition characteristics.

6.4. Steam Reforming of Bio-Oils

Steam reforming of bio-oils produces syn-gas, which can then be converted into a range of fuels as discussed in Section 4.0. One application of this technology would be to have a number of smaller plants that produce bio-oils, which are then transported to a large central biorefinery where the bio-oils are converted into syn-gas-derived fuels.²³⁶ The large biorefinery could take advantage of the economy of scale, and transporting the dense bio-oil is cheaper than transporting biomass. Black liquor, the major waste biomass-containing stream from chemical pulp and paper production, also can be converted into syn-gas by steam reforming.²³⁷ Steam reforming of fossil fuels is a well-established technology,⁵¹ and steam reforming of bio-oils is an extension of this technology. Steam reforming reactions occur at high temperature (600–800 °C) and high space velocities usually with a Ni-based catalyst.

According to Czernik et al., the most important parameters for steam reforming of bio-oils are temperature, steam-to-carbon ratio, and catalyst-to-feed ratio.²³⁸ Steam reforming of bio-oils is complicated since some bio-oil components are thermally unstable and decompose upon heating. Deactivation of the catalysts due to coking is one of the major problems, and bio-oils have more deactivation problems than do petroleum-derived feedstocks. In fact, steam reforming of bio-oils in fixed bed reactors requires a catalyst regeneration step after 3–4 h of time-on-stream.²³⁸ While bio-oils are more reactive than petroleum oils, high temperature is needed in the reactor to gasify coke deposits formed by thermal decomposition. High ratios of steam to carbon (greater than 7) are necessary to avoid catalyst deactivation by coking. Czernik et al. developed a fluidized bed reactor for steam reforming of bio-oils.²³⁸ Catalysts were more stable in the fluidized bed reactor than in the fixed bed reactor due to better contacting of the catalyst particle with steam.²³⁸ The current problem with fluid bed catalysts is due to catalyst attrition, and attrition resistant catalysts are being developed.

Another advantage of steam reforming of bio-oils is that higher value products in the bio-oils can be separated from the low value products, which can then be steam reformed.²³⁸ Bio-oils separate into an aqueous and organic fraction by the addition of water to the bio-oil. The organic fraction could be used to make chemicals, such as phenol-formaldehyde resins, or could be alternatively converted to aromatic hydrocarbons and ethers that can be used as high-octane gasoline blending components (Section 9.2). The aqueous fraction can be converted into syn-gas by steam reforming.²³⁹

The steam reforming of model biomass compounds, including acetic acid, acetone, phenol, ethanol, cresol,

dibenzyl ether, glucose, xylose, and sucrose, has been carried out with Ni²⁴⁰ and noble metal-based catalysts.^{241,242} Acetic acid caused coking problems on the Ni catalyst surface, while glucose, xylose, and sucrose thermally decomposed prior to the catalyst bed.²⁴⁰ The sugars once volatilized did not cause coking problems on the catalyst surface but decomposed in tubing prior to the catalyst bed. Nobel metal catalysts, including Pt, Rh, and Pd supported on Al₂O₃ and CeO₂–ZrO₂ were able to steam reform acetic acid, acetone, phenol, and ethanol.²⁴¹ Synthesis gas can also be produced from gasification of biomass-derived oils without any catalysts.²⁴³

One potential way of improving steam reforming of bio-oils would be to partially hydrogenate the bio-oils prior to the steam reforming section. Partial hydrotreating of bio-oils at lower temperature will improve the thermal stability of bio-oils and should decrease the amount of coking on the catalyst. The hydrogen produced by steam reforming could be recycled for hydrogenation purposes.

6.5. Steam Reforming of Chars

During bio-oil production, chars are produced, which can be converted into H₂ or syn-gas by steam reforming.^{244,245} Alternatively, the chars can be burned as a solid fuel. Steam reforming of chars occurs at temperatures from 700 to 800 °C, steam flow rates of 2.5–15 g/(h–g_{char}) and residence times from 0.5 to 2 h without any catalyst. The reaction takes place in a bed containing the char with flowing steam. The concentration of the gases is dependent on the reaction conditions, but the methane concentration is less than 2 mol % with the remaining product gas being H₂, CO and CO₂. Up to 90% of the char can be gasified. One potential future application of this technology would be the steam reforming of carbon deposited on catalyst during Bio-Oils upgrading.

6.6. Economic and Thermal Analysis of Processes for Bio-Oil Upgrading

Bio-oils need to be upgraded if they are to be used as a transportation fuel. Each conversion technology has advantages and disadvantages. Hydrotreating of bio-oils can produce a stable, energy dense, noncorrosive oil, but requires high-pressure H₂. Zeolite upgrading does not require H₂, but extensive coking occurs on the catalyst surface. Bio-oils can form emulsions with diesel fuel, but this fuel has a high corrosivity, and requires expensive emulsifying agents. Steam reforming of bio-oils is a technically possible route, but as discussed in Section 4.5, the thermal efficiency is low for syn-gas production and the subsequent conversion into fuels. The overall mass and PTE for production of bio-oils from wood by fast pyrolysis followed by conversion into refined liquid fuels by hydrotreating or zeolite upgrading is shown in Table 17.²²³ The pyrolysis oil contains approximately 70% of the energy and 83% of the mass of the wood feedstock. The energy content of the fuel after hydrotreating and zeolite upgrading is 63% and 53% of the wood feedstock. Further refining of the hydrocarbons reduces the mass and energy content to 25–27% and 55% of the wood feedstock, respectively. These process thermal efficiencies are higher than the PTE for syn-gas-derived liquid fuels production using biomass gasification and FTS (Table 9).

Evans et al. have estimated that cost of producing H₂ by steam reforming of pyrolysis vapors is \$9.51/GJ, \$7.78/GJ, and \$6.05/GJ when the biomass feedstock is available at \$48, \$24, and \$0 per metric-ton of dry biomass, respectively.²⁴⁶

Table 17. Overall Mass and Process Thermal Efficiencies (PTE) for Conversion of Wood into Liquid Fuels by Pyrolysis and Catalytic Upgrading (Hydrotreating and Zeolite)^a

	pyrolysis oil		partially hydro-treated		crude hydrocarbons		refined hydrocarbons	
	mass	PTE	mass	PTE	mass	PTE	mass	PTE
hydro-treating	0.83	0.70	0.50	0.66	0.30	0.63	0.27	0.55
zeolite	0.83	0.70			0.23	0.53	0.25	0.55

^a Adapted from Bridgwater.²²³ This table does not include the energy added to the hydrocarbon by the hydrogen.

The cost of H₂ from bio-oil steam reforming is similar to the commercial cost of H₂, which in 2003 was \$5.7–11/GJ according to Spath and Dayton.¹¹⁴ The cost of H₂ is dependent on the cost of fossil fuels, and as the cost of fossil fuels increases the cost of H₂ will also increase.

All of the bio-oil upgrading routes should be explored in the future, and new catalysts need to be developed for these routes to become economical. It would be ideal to use the functionality of the bio-oils to produce a high quality transportation fuel. For example if the acids and alcohols in the bio-oil could react to form esters this might improve the characteristics of the bio-oil. Future work will also require that the upgrading system be integrated into the biorefinery plant. Niche markets, for high-value products from bio-oils are the near term application of bio-oils. As bio-oil production becomes more efficient, and bio-oil upgrading technology improves, it is likely that bio-oils derived from pyrolysis and/or liquefaction could be used as a transportation fuel.

7.0. Biomass Monomer Production

The previous methods for lignocellulose biomass conversion require high-temperature treatments (greater than 500 °C) for production of gases, liquids or solids. In this section, we discuss how to selectively convert cellulosic biomass into monomer units by low temperature reactions where the first reaction involves acid hydrolysis. The monomer units are then selectively converted into targeted fuels as discussed in the following sections (8.0 and 9.0). Biomass conversion into monomer units is a function of the biomass type and some plant materials, such as cane sugar and corn, are easily converted into monomer units. Lignocellulose is difficult to break up into monomer units due to its recalcitrant nature, and a significant amount of research has been done to selectively convert this low-cost material into monomer units. Biomass hydrolysis can allow the selective and energy-efficient conversion of biomass into monomer units, which can then be selectively converted into fuels or chemicals.

7.1. Pretreatment

To achieve high yields of glucose, lignocellulose must first be pretreated. The goal of pretreatment is to decrease the crystallinity of cellulose, increase biomass surface area, remove hemicellulose, and break the lignin seal.²⁴⁷ This pretreatment changes the biomass structure and improves downstream processing. Pretreatment methods include physical, chemical, and thermal or some combination of the three. Pretreatment is one of the most expensive processing steps for the production of sugars from biomass, and the costs have been estimated to be as high as \$0.08/L_{ethanol}.²⁴⁷ Pretreatment is also one of the least understood processing options. A

Table 18. Effect of Promising Pretreatment Methods on the Structure and Composition of Lignocellulose Biomass^a

pretreatment method	increases surface area	decrystallizes cellulose	removes hemicellulose	removes lignin	alters lignin structure
uncatalyzed steam explosion	***		***		*
liquid hot water	***	N.D.	***		*
pH controlled hot water	***	N.D.	***		N.D.
flow-through liquid hot water	***	N.D.	***	*	*
dilute acid	***		***		***
flow-through acid ammonia fiber	***	***	*	***	***
explosion (AFEX)	***	***	*	***	***
ammonia recycled percolation (ARP)	***	***	*	***	***
lime	***	N.D.	*	***	***

^a Adapted from Mosier et al.²⁴⁷ ***, major effect; *, minor effect; N.D., not determined.

recent issue of *Bioresour. Technol.* is dedicated to pretreatment methods.^{247–250}

According to Wyman et al. the following is a list of desirable pretreatment attributes:²⁴⁷

- (1) Low cost of chemicals for pretreatment, neutralization, and subsequent conditioning
- (2) Minimal waste production
- (3) Limited size reduction because biomass milling is energy-intensive and expensive
- (4) Fast reactions and/noncorrosive chemicals to minimize pretreatment reactor cost
- (5) The concentration of hemicellulose sugars from pretreatment should be above 10% to keep fermentation reactor size at a reasonable level and facilitate downstream recovery.
- (6) Pretreatment must promote high product yields in subsequent enzymatic hydrolysis or fermentation operations with minimal conditioning costs.
- (7) Hydrolysate conditioning in preparation for subsequent biological steps should not form products that have processing or disposal challenges.
- (8) Low enzyme loading should be adequate to realize greater than 90% digestibility of pretreated cellulose in less than 5 days and preferably 3 days.
- (9) Pretreatment should facilitate recovery of lignin and other constituents for conversion to valuable co/products and to simplify downstream processing.

Physical pretreatment methods include ball milling, comminution (mechanical reduction of biomass particulate size), and compression milling. Solvents such as H₂O₂, ozone, glycerol, dioxane, phenol, or ethylene glycol have been used for biomass pretreatment, and these solvents are known to break apart cellulose structures and promote hydrolysis.²⁴⁷ However, solvent pretreatments appear too expensive for practical purposes.²⁴⁷ According to Mosier et al., the most cost-effective and promising pretreatment methods are dilute acid, uncatalyzed steam explosion, pH controlled hot water, treatment with lime, and treatment with ammonia.²⁴⁷

Table 18 shows the effect of various pretreatment methods on the chemical and physical structure of lignocellulosic biomass. Uncatalyzed steam explosion is used commercially to remove hemicellulose for the manufacture of fiberboard and other products by the Masonite process.²⁴⁷ High pressure steam is applied to wood chips for a few minutes without the addition of chemicals, and this process is terminated by decompression of the steam. This process increases the surface area without decrystallizing the cellulose, and cellulose downstream digestibility is significantly improved.²⁴⁷

Water treatments at elevated temperatures (200–230 °C) and pressures can increase the biomass surface area and remove hemicellulose.^{247,249,250} Three types of reactors are used for hot water pretreatment including co-current (biomass and water are heated together for a certain residence time), countercurrent (water and lignocellulose move in opposite directions), and flow through (hot water passes over a stationary bed of lignocellulose).²⁵¹ The advantage of hot water treatment is that acid addition and size reduction are not needed. A disadvantage of these methods is that hot water treatment forms sugar degradation products (furfural from pentoses and HMF from glucose). The degradation products can be minimized by controlling the pH of the hot water by addition of bases such as potassium hydroxide.

Dilute sulfuric acid treatments can be used to hydrolyze hemicellulose to sugars with high yields, change the structure of the lignin, and increase the cellulosic surface area.^{247,249,250} The disadvantage of this process is that it requires corrosive acid, with corresponding downstream neutralization, and special materials for reactor construction. Ammonia fiber/freeze explosion (AFEX), where anhydrous ammonia is contacted with lignocellulose, can increase the surface area of the biomass, decrease crystallinity of cellulose, dissolve part of the hemicellulose, and remove lignin. Treatment of the biomass with a less concentrated ammonia solution is known as ammonia recycled percolation (ARP). Ambient conditions can be used for lime treatments; however, the time required for these treatments is in terms of weeks. This process involves mixing lime with water and spraying it onto the biomass. The major effect of lime pretreatment is removal of lignin. The biomass surface area is increased, and the acetyl and uronic acid fractions of hemicellulose are removed.

Table 19 shows the results of different pretreatment methods followed by enzymatic hydrolysis for production of sugars from corn stover.²⁴⁹ Table 20 lists the reaction conditions for the pretreatments.²⁴⁹ Using corn stover feedstocks sugar yields of over 90% were obtained with the various pretreatments. A hot water treatment with a flow through reactor was the pretreatment method with the highest overall soluble product yield; however, the xylose monomer yield was only 2.4%, meaning this method did not produce xylose monomers. A dilute acid pretreatment method produced the highest amounts of sugar monomers with a 92% yield. Results are expected to be different with other feedstocks.

Table 19. Xylose and Glucose Yields of Corn Stover after Various Pretreatments Followed by Enzymatic Hydrolysis^a

pretreatment system	xylose yields (% , max 37.7)			glucose yields (% , max 62.3)			total sugar yields (%)		
	stage 1	stage 2	total	stage 1	stage 2	total	stage 1	stage 2	total
dilute acid	32.1(31.2)	3.3	35.3(34.5)	3.9	53.3	57.2	36.0(35.1)	56.6	92.5(91.7)
flowthrough	36.3(1.7)	0.8(0.7)	37.1(2.4)	4.5(4.4)	57.0	61.5(61.4)	40.8(6.1)	57.8(57.7)	98.6(63.8)
partial flow pretreatment	31.5(2.8)			4.3(4.2)					
controlled pH	21.8(0.9)	8.9	30.7	3.5(0.2)	54.7	58.2	25.3(1.1)	63.6	88.9
AFEX		ND(30.2)	ND(30.2)		61.8	61.8		ND/92.0	ND/92.0
ARP	17.8(0)	17.0	34.8(17.0)	0	59.4	59.4	17.8(0)	76.4	94.2(76.4)
lime	9.2(0.3)	20.2	29.4(20.5)	1.0(0.3)	59.5	60.5(59.8)	10.2(0.2)	79.7	89.9(80.3)

^a Adapted from Wyman et al.²⁴⁹ Stage 1 is pretreatment of corn stover and stage 2 is enzymatic hydrolysis after pretreatment with a cellulose loading of 60 FPU/g of glucan in the original corn stover. The value reported in each column is sugars plus oligomers, while the value in parentheses is the value for monomers only. A single value indicates that only monomers were observed.

Table 20. Optimal Pretreatment Conditions for Ethanol Production from Corn Stover

pretreatment system	chemicals	temp (°C)	pressure (atm)	reaction time (min)	solid conc (wt %)
dilute acid	0.5–3.0 wt % sulfuric acid (0.49 wt %)	130–200 (160)	3–15	2–30 (20)	10–40 (25)
flowthrough	0.0–0.1 wt % sulfuric acid (0.0 wt %)	190–200 (200)	20–24	12–24 (24)	5–30
pH controlled	water or stillage	160–190 (190)	6–14	10–30 (15)	5–30 (16)
AFEX	100% (1:1) anhydrous ammonia	70–90 (90)	15–20	<5 (5)	60–90 (62.5)
ARP	10–15 wt % ammonia (15 wt %)	150–170 (170)	9–17	10–20 (10)	15–30
lime	0.05–0.15 Ca(OH) ₂ /g _{biomass} (0.08)	25–60 (55)	1	2–8 weeks (2 weeks)	10–20

^a Adapted from Wyman et al.^{249,250} The optimal reaction parameters are in parentheses.

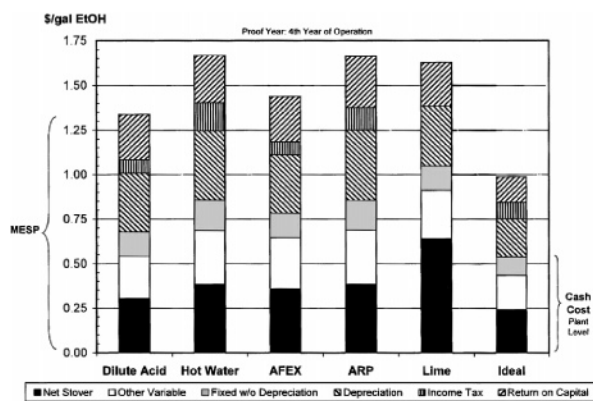

Figure 22. Ethanol production cost with various pretreatment methods from Eggeman and Elander.²⁴⁸ (Reprinted from ref 248 with permission. Copyright 2005 Elsevier.)

An economic analysis of ethanol production using the various pretreatment methods was conducted by Eggeman and Elander, and the results are shown in Figure 22.²⁴⁸ The cost of ethanol production increases as dilute acid < AFEX < lime < ARP < hot water. The reason hot water pretreatment is so expensive is that it requires more enzymes to break down the xylose oligomers. If the oligomers could be successfully converted into ethanol (or other products), then the cost of making ethanol for the various pretreatment method decreases for the hot water, ARP, and lime method, all of which make a significant amount of oligomers.

7.2. Hydrolysis

The hydrolysis reaction for cellulose conversion into sugar polymers is shown in eq 15. Hydrolysis of cellulose is significantly more difficult than for starches because cellulose is in a crystalline form with hydrogen bonding (Section 2.1). The hydrolysis reaction can be catalyzed by acids or enzymes, and a recent review has been written by Wyman et al.³ Cellulase enzymes are able to catalyze the reaction with yields close to 100% at 50 °C. The National Renewable

Energy Laboratory (NREL) has estimated that the cost of unrefined sugar monomers, in an aqueous solution, produced from lignocellulose would be 12–14¢/kg_{sugar}.¹⁷¹ Lynd et al. have projected the price of sugars could decrease to as low as 5.3¢/kg.¹³

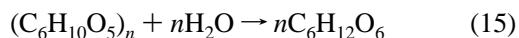

Earlier cellulose hydrolysis kinetic models, developed by Saeman,²⁵² involve two first-order reactions where the first involves cellulose hydrolysis to glucose followed by glucose decomposition (eq 16). Undesired byproducts including 5-hydroxymethylfurfural (HMF) and levulinic acid are produced by acid-catalyzed degradation of sugars. Most hydrolysis data were fit to this simple model from 1945 to 1990, and Table 21 shows the model parameters from various studies.²⁵³ Using these parameters the maximum yield of glucose is always less than 70%. Enzymatic hydrolysis can produce glucose yields above 95% as shown in Table 19. The acid hydrolysis of cellulose has a lower activation energy than lignocellulose, thus showing the effect of lignin on the acid hydrolysis reaction.

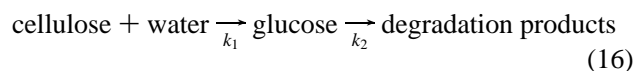

More complicated kinetics models have been developed based on mechanistic data. Oligomer conversion into glucose is 2–3 times faster than conversion of cellulose to glucose; however, oligomers have been observed during hydrolysis.³ These observations lead to the development of a two-step model where cellulose is converted into oligomers, which are then converted into glucose. Mok and Antal observed that in addition to the hydrolysis pathway another pathway occurs that produces a modified cellulose that cannot be hydrolyzed to glucose as shown in Figure 23.²⁵⁴ Importantly, this model suggests that cellulose structural rearrangements can occur with high-temperature treatments. The acid hydrolysis reactions are heterogeneous with the solid biomass

Table 21. Kinetic Parameters for Acid Hydrolysis of Various Biomass Feedstocks with the Saeman Model (eq 14)^a

feed	temp (°C)	acid conc (wt %)	K_1 (min ⁻¹)	K_2 (min ⁻¹)	E_1 (kJ/mol)	E_2 (kJ/mol)	m	n
glucose	160–260	?		1.85×10^{14}		136		1.0
cellulose	100–130	5–40 H ₂ SO ₄	1.57×10^{14}		142		1.42	
Douglas fir	170–190	0.4–1.0 H ₂ SO ₄	1.73×10^{19}	2.38×10^{14}	180	137	1.34	1.02
Kraft paper	180–230	0.2–1.0 H ₂ SO ₄	28×10^{19}	4.9×10^{14}	189	137	1.78	0.55
newsprint	200–240	1.0 H ₂ SO ₄	28×10^{19}	4.8×10^{14}	189	137	NR	NR
Solka-floc	180–240	?	1.22×10^{19}	3.79×10^4	178	137	NR	NR
Cane bagasse	100–130	5–40 H ₂ SO ₄	1.15×10^{21}		152		1.42	

^a Adapted from Fan et al.²⁵³ Saeman model is represented as cellulose + water $\xrightarrow{k_1}$ glucose $\xrightarrow{k_2}$ degradation products where $k_1 = K_1(\text{Con}_{\text{acid}})^m \exp(-E_1/RT)$ and $k_2 = K_2(\text{Con}_{\text{acid}})^n \exp(-E_2/RT)$ with Con_{acid} in wt fraction of acid.

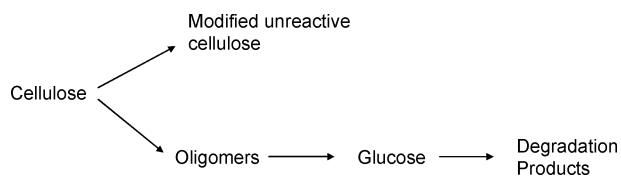
**Figure 23.** Cellulose acid-catalyzed hydrolysis pathways adapted from Mok and Antal.²⁵⁴

reacting with liquid acid. Thus, mass transfer limitations also can play a role in hydrolysis.

The mechanism for C–O–C bond cleavage in cellulose involves protonation of glucoside bonds as shown in Figure 24. The proton can either attack the oxygen bond between the two glucose units or the cyclic oxygen, which is defined as pathways A-1 and A-2, respectively.²⁵³ The mechanism is thought to involve the rapid formation of an intermediate complex with the oxygen and proton, followed by the slow splitting of glucosidic bonds by the addition of a water molecule.

Heterogeneous reactions occur during cellulose hydrolysis in the biomass where the acid first penetrates into disordered cellulose regions leading to an initial rapid decrease in the

degree of polymerization (DP).²⁵³ After the rapid initial decrease, the DP reaches an asymptotic value where the DP remains at a constant value called the degree of polymerization (LODP). The LODP is dependent on the type of cellulose samples and is reached when only 2–5% of the sample has been hydrolyzed. The average length of crystallite in the cellulose sample is considered to be the same as the LODP. Oxidation of cellulose (with oxidizing agents such as H₂O₂, NaClO₂, O₃, KBrO₃, etc.) prior to hydrolysis or during progressive hydrolysis reduces the DP of partially hydrolyzed residues. This treatment decreases the aldehyde concentration and increases the carboxyaldehyde concentration, which prevents recrystallization. Recrystallization can occur during acid or enzymatic hydrolysis.²⁵³

Prior to enzymatic hydrolysis, the cellulose structure must be pretreated to open up the structure of biomass for reaction of the cellulose with cellulase. Initially, a process was designed to produce ethanol through enzymatic hydrolysis by separate hydrolysis and fermentation (SHF) steps. This involved using improved enzymes from the fungus *Trichoderma reesei*.³ Problems with this methods are that cellobiose and glucose inhibit the reaction, which increased enzyme

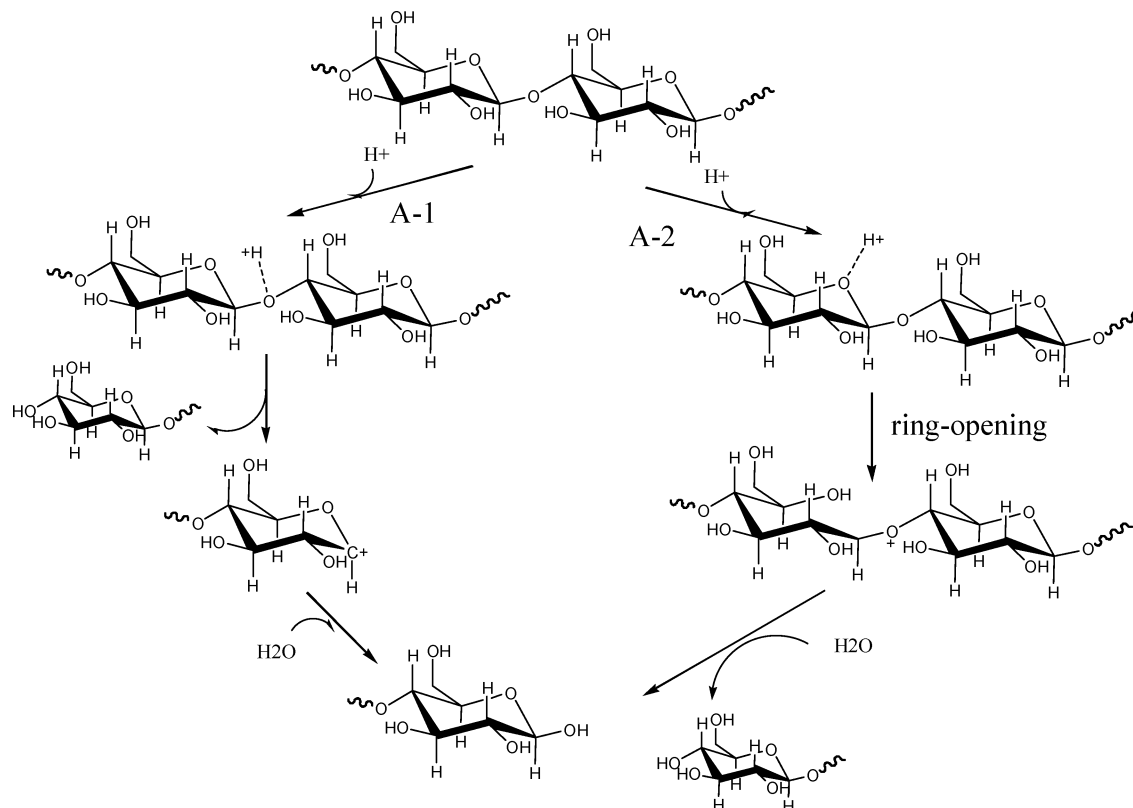
**Figure 24.** Mechanism of acid hydrolysis of cellulose adapted from Fan et al.²⁵³

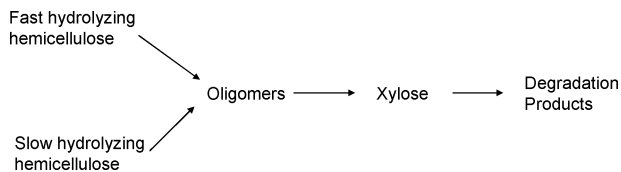

Figure 25. Kinetic model of hemicellulose degradation adapted from Wyman et al.³

cost. This problem can be reduced by a process known as simultaneous saccharification and fermentation (SSF) where the vessel contains both cellulase and fermentative organisms to convert glucose rapidly to ethanol. This process significantly reduces the concentration of glucose. Although the temperature of the SSF process is lower than the optimal temperature for enzymatic hydrolysis because the fermentation organisms are not stable at these higher temperatures, the rates, concentrations, and yields are still better than for SHF.

Cellulases, the enzymes that catalyze cellulose hydrolysis, were initially categorized based on the reaction they catalyze. More recently, they have been classified based on structural properties. Three major types of enzymatic reactions are reported including (1) endoglucanases or 1,4- β -D-glucan-4-glucanohydrolases, (2) exoglucanases or 1,4- β -D-glucan glucanohydrolases (also known as celloextrinases), and (3) β -glucosidases or β -glucoside glucohydrolases.²⁵⁵ Endoglucanases react with internal amorphous cellulose sites to produce shorter chains of varying lengths and expose chain ends. Exoglucanases hydrolyze the ends of cellulose produced by endoglucanase in a progressive matter to produce cellobiose as the major product. β -Glucosidases convert cellobioses and cellobiose to glucose. The hydrolysis mechanism in an enzyme occurs using a proton donor and nucleophile or base. Cellulase systems act in a coordinated manner to efficiently hydrolyze cellulose and consist of more than just a combination of the three enzyme systems.²⁵⁵ Recent reviews have been published on kinetic modeling of cellulose enzymatic hydrolysis.^{255,256}

Acid hydrolysis of hemicellulose occurs under less harsh conditions than cellulose because hemicellulose is an amorphous polymer. Hemicellulose hydrolysis even occurs in hot water (~ 210 °C), where the water is thought to break down

hemicellulose and release acetic acid, which continues to catalyze the reaction.²⁵⁷ Water-soluble oligomers form in high yields with hot water treatments. Dilute acid treatments of lignocellulose at 160 °C, 10 min reaction time, and 0.7 wt % acid, yields 85–90% of the hemicellulose sugars.²⁵⁸ Kinetic models usually incorporate two types of hemicellulose a fast hydrolyzing type and a slow hydrolyzing type as shown in Figure 25.³ The proportion of fast and slow fractions is typically 65 and 35%, as determined by fitting kinetic data. Oligomer intermediates are experimentally observed but frequently ignored in kinetic models. Wyman et al. said concerning hemicellulose models that “although significant effort has been devoted to describing the kinetics of hemicellulose hydrolysis, the models do not predict consistent results.”³ For example, the rate of xylose degradation in kinetic models is different than the rate of pure xylose degradation. The hemicellulose also is associated with lignin, and this type of bonding could change the kinetics. Future mechanistic work could help clarify the heterogeneous mechanism of acid hydrolysis of biomass leading to further process improvement.

7.3. Levulinic Acid

Levulinic acid can be selectively produced from cellulosic biomass. Levulinic esters and methyl-tetrahydrofuran, which can be used as oxygenated diesel and gasoline fuel additives, respectively, can be produced by esterification and hydrogenation of levulinic acid (Section 9.2). Levulinic acid is the final acid-catalyzed dehydration product formed from sugars or cellulose, as shown in Figure 26, with formic acid (in a 1:1 molar ratio) and water as coproducts. During this reaction, large amounts of solid products (humics or tars) also are formed. A mechanism (Figure 26) for levulinic acid formation was been reported by Horvat et al.²⁵⁹

BioMetrics Inc. developed the biorefine process to produce levulinic acid at 50–70% yields from cellulosic feedstocks, including paper mill waste, wood waste, and agricultural residues, using dilute acid hydrolysis.^{260–262} This process occurs in a two-stage reactor (Figure 27), where the first reactor is a plug flow, and the second is a CSTR reactor. The feed contains 2–5 wt % H_2SO_4 , and the reaction conditions are 215 °C, 31 atm, and 15 s residence time for

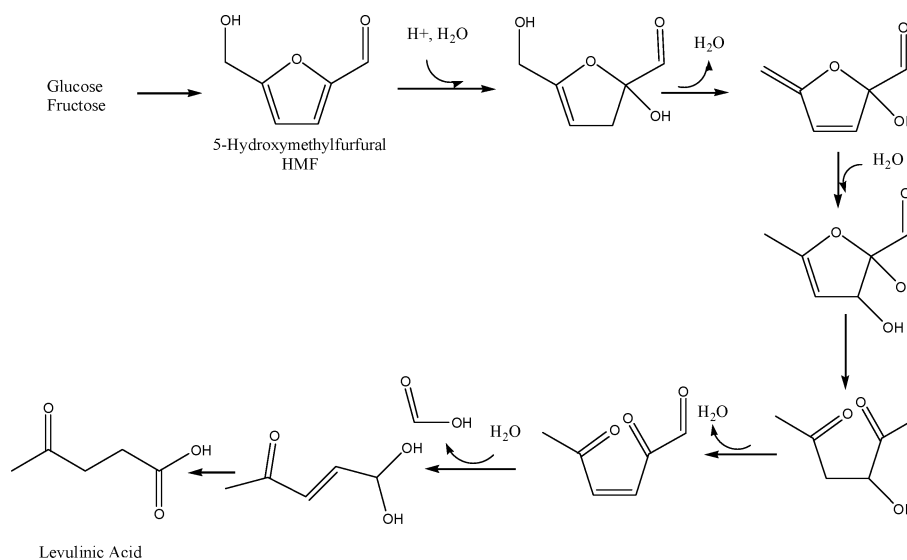

Figure 26. Mechanism for formation of levulinic acid from HMF according to Horvat et al.²⁵⁹

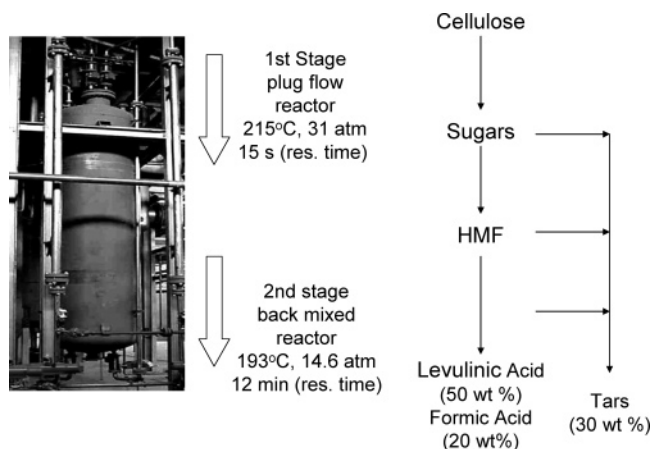

Figure 27. Production of levulinic acid by the biorefinery process adapted from Manzer.¹⁹

the first reactor; and 193 °C, 14.6 atm, and 12 min residence time for the second reactor.

A pilot plant was operated for 1 year using paper sludge feedstocks and producing levulinic acid (70% yield from cellulose), formic acid (50% yield from cellulose), furfural (80% yield from hemicellulose), and char at a feed rate of 1 dry ton/day. BioMetrics estimated that a large-scale plant (1000–2000 dry tons/day) could produce levulinic acid for \$0.09–0.11/kg. During the process, the cellulose is first converted into sugars, which are then converted into levulinic acid, formic acid, and chars (Figure 27). Cellulose conversion into sugars is a fast reaction, whereas subsequent sugar conversion into levulinic acid is a slow reaction. Typical yields were approximately 0.5 kg of levulinic acid/kg of cellulose. The process can use wet feedstocks without drying, improving the overall process energy efficiency.

7.4. Hydrogenation/Hydrolysis

Hydrolysis of biomass can be combined with hydrogenation to produce xylitol, sorbitol, and sorbitan from cellulose, aspen, switchgrass, and wood biomass resources at an estimated polyol cost of \$0.055–0.070/kg.²⁶³ This is done by adding a Ru/carbon catalyst for hydrogenation, with H₃-PO₄ acid catalyst for hydrogenolysis, at 155–170 °C and 30–50 atm H₂. Approximately 50–70% of the cellulose and hemicellulose were converted into polyols. Xylitol, sorbitol, and sorbitan can be used as feedstocks for fuels production by aqueous-phase processing.

8.0. Sugar Conversion into Fuels

This section discusses production of fuels from sugar monomers.

8.1. Ethanol Production

Presently, the production of ethanol by fermentation of carbohydrates is the primary technology for the generation of liquid fuels from renewable biomass resources. In 2001, the U.S. and Brazil produced 6.63×10^9 and 11.2×10^9 L of ethanol per year, respectively.²⁶⁴ Ethanol can be used directly as a fuel, and in Brazil hydrous ethanol, which consists of 95.5% ethanol and 4.5% water, is used to power vehicles.²⁶⁴ Ethanol is also blended with gasoline, and in the U.S. most ethanol is sold as a blend of 10% ethanol and 90% gasoline. Brazil also blends ethanol with gasoline. The U.S. Clean Air Act of 1990 mandated the use of oxygenates

in fuels in winter months for areas with high CO levels, and ethanol oxygenates gasoline. Ethylene hydration is another method used to make ethanol from petroleum. Sugars are converted to ethanol by fermentation usually with the yeast *Saccharomyces cerevisiae* as shown in eq 17. Although almost half of the mass of sugar is released as CO₂, almost all of the sugar energy is captured in the ethanol. *S. cerevisiae* ferments glucose, mannose, fructose, and galactose. High theoretical yields of ethanol are obtained from this reaction, and small amounts of byproducts including glycerol, acetic acid, lactic acid, succinic acid, and fusel oil are formed. Yeast production requires a small amount of the sugar as a feedstock.

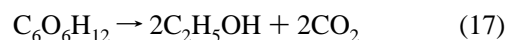

Industrially, a number of different biomass feedstocks are used for ethanol production as shown in Figure 28. The first

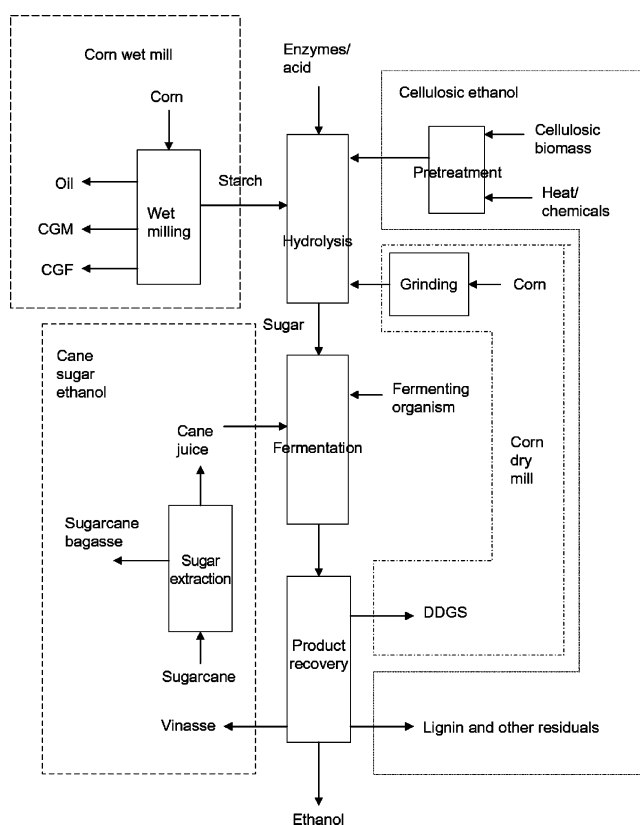

Figure 28. Block flow diagram for ethanol production from corn, cane sugar and cellulosic biomass from Wyman.²⁶⁴ Corn wet mills produce corn oil, corn gluten meal (CGM), and corn gluten feed (CGF) for food and animal feed. Corn dry mills produce an animal feed called DDGS after the fermentation process. (Reprinted from ref 264 with permission. Copyright 2004 Elsevier.)

step in ethanol production is conversion of the biomass into fermentable sugars. This conversion step depends on the feedstock. Sugarcane is converted into water-soluble sugars or cane juice (30 wt % of sugarcane) and insoluble lignocellulose or sugarcane bagasse, and sugar fermentation does not require extensive pretreatment. The sugarcane bagasse is burned to provide heat for the process. The sugars are heated to 105–110 °C to reduce microbial contamination, nutrients such as ammonium sulfate and other salts are added, and fermentation is carried out at about 20 wt % sugar concentration, pH 4–5, temperatures 30–38 °C, and residence time of 28–48 h.^{2,264} Typical yields for ethanol

Table 22. Production Costs, Energy Ratios, and Thermal Efficiencies for Ethanol Production from Sugarcane, Corn Grain, and Lignocellulose Biomass and Diesel Fuel^a

feedstock	sugarcane	corn grain	corn stover (lignocellulose)	diesel fuel ^b
costs				
feedstock cost (\$/L)	0.127–0.134	0.21–0.25	0.088	
coproduct credits (\$/L)		(0.07–0.11)		
estimated production costs (\$/L)	0.21–0.25	0.25	0.31–0.38	0.44
estimated production costs (\$/GJ _{HHV})	4.9–5.9	5.9	7.25–8.89	11
fossil energy ratio (MJ _{fossil fuel} /MJ _{product}) ^c				
biomass production	0.09–0.14	0.25	0.06–0.15	1.113
biomass transport	?	0.03	0.01–0.04	0.016
ethanol production	0.02–0.04	0.62 (0.16–0.37) ^d	0.00	0.064
ethanol conversion	?	0.02	0.01–0.05	0.006
overall	0.10–0.18	0.92 (0.46–0.67) ^d	0.08–0.24	1.199
process thermal efficiency (PTE)	0.20–0.45 ^e	0.41 (0.46–0.51) ^f	0.49 (0.53) ^g	0.94
life cycle thermal efficiency (LCTE)	0.19–0.43 ^e	0.26 (0.28–0.30) ^f	0.39–0.45 (0.43–0.49) ^g	0.83

^a From Shapouri et al. 2002,¹⁷⁷ Shapouri et al. 1998,²⁶⁷ Wyman,²⁶⁴ Aden et al.,¹⁷¹ Wooley et al.,²⁶⁸ and Sheehan et al.³²⁸ ^b Diesel fuel at a cost of \$57/bbl. Diesel fuel costs are the FOB spot price of diesel fuel at New York Harbor.¹⁴ ^c Fossil energy ratios are estimated with higher heating value of ethanol of 23.404 MJ/L_{ethanol}. ^d Fossil energy ratios and efficiencies for ethanol production from corn decreases depending on how energy credits are given for coproducts.¹⁷⁷ The values in parentheses are the number with coproduct energy credits. ^e The process and life cycle thermal efficiencies take into account the energy in the bagasse. It is assumed that the energy content of bagasse and the sugars are equal. Sugarcane contains 12–17 wt % sugars and 68–72 wt % moisture.²⁶⁴ ^f The process and life cycle thermal efficiencies take into account the energy in the corn stover. It is assumed that corn stover and the sugars have equal energy content, and the mass ratio of corn grain to corn stover is 1:1. The process thermal efficiency does not include the energy required for fossil fuel production. ^g The values in parentheses count electricity generation as a coproduct.

production from sugarcane are 160–190 L/metric ton.² The sugars are then distilled to azeotropic levels (95% ethanol) and can be dried further using molecular sieves.

Ethanol is produced from corn grains and other starches by either wet or dry milling. Corn grain contains 70 wt % starch, 10–11 wt % crude protein, 4.5–6.0 wt % oil, 6 wt % hemicellulose, 2–3 wt % cellulose, 1 wt % lignin, and 1 wt % ash.²⁶⁴ The first step in a dry milling plant is to mechanically grind the grain to a 40-mesh size to rupture the hull walls and expose the starch polymers. The grain is then heated with water to 85 °C, mixed with α -amylase enzyme, held for 1 h and heated further to 110–150 °C to reduce bacteria levels and liquefy the starch. This is followed by cooling back to 85 °C for 1 h with the addition of more α -amylase.²⁶⁴ The stream is further cooled and gluco-amylase enzyme is added to finish process.

In the wet milling process, the crude starch, gluten, and corn oil fractions are separated through a series of steeping, milling, and separation steps.²⁶⁴ The products include gluten meal, gluten feed, corn germ, meal, and corn oil, which can be used for human consumption or animal feed. In a dry mill plant, a coproduct protein, known as distillers dried grains with solubles (DDGS) or distillers dried grains (DDG) is recovered after distillation. The ethanol solution, at 12–14 wt % ethanol, is then distilled to azeotropic levels (95% ethanol) and dried further using molecular sieves. The sugars are fermented in both wet and dry milling processes with *S. cerevisiae*, and typical yields range from 460 to 490 L/metric ton corn grain.^{2,264} The ethanol yields from corn grain are higher than those from sugarcane; however, sugarcane has a higher yield per land area (Section 2.1).

While not currently done commercially, research is being carried out to produce ethanol from lignocellulosic biomass. The NREL has modeled a process for conversion of corn stover (lignocellulose) to ethanol based on dilute acid prehydrolysis and enzymatic hydrolysis.¹⁷¹ The first step in this process is feedstock size reduction to the appropriate size. The cellulose is then treated in sulfuric acid (1.1 wt %) for 2 min at 190 °C and 12 atm to release most of the hemicellulose sugars and acetic acid. The reaction is then flash cooled to drop the temperature to 100 °C, and the acid

is neutralized with lime to a pH of about 10. The resulting solid fraction is sent to a saccharification unit where the cellulose is hydrolyzed to glucose and cellobiose. The saccharification reaction occurs at 65 °C for 1.5 days. Cellulose enzymes catalyze the hydrolysis reactions. These enzymes contain (1) endoglucanases, which reduce the cellulose polymer size, (2) exoglucanases, which attack the ends of cellulose fibers, allowing it to hydrolyze highly crystalline cellulose, and (3) β -glucosidase, which hydrolyze cellobiose released by exoglucanase to glucose. Cellulase is produced industrially from *T. reesei*. Genencor International and Novozymes Biotech are the two largest manufacturers of this enzyme.

In the NREL configuration, the resulting glucose sugar stream is combined with the xylose sugar stream and fermented to ethanol with the recombinant *Zymomonas mobilis* bacterium at 41 °C for 1.5 days. The bacterium must be grown in a seed fermentation vessel in a separate process area. Lignocellulose also contains xylose sugars, which cannot be fermented by *S. cerevisiae* without genetic modification. Organisms have been developed that ferment both xylose and glucose.^{265,266} The ethanol water solutions are distilled to around 95% ethanol, where ethanol and water form an azeotrope. Ethanol is further purified using molecular sieves. The solids left are concentrated in a triple effect evaporator. The first ethanol plant from cellulose (which is currently not in operation) was built in South Carolina in 1910 and gave 83 L_{ethanol}/metric ton_{biomass} (sawdust).² It is estimated that the new NREL design has a yield of 320 L_{ethanol}/metric ton_{drybiomass}.¹⁷¹

Production costs of ethanol will be highly dependent on the regional cost of producing biomass. Typical ethanol production costs from sugarcane, corn grain, and lignocellulose are shown in Table 22.^{171,264,267,268} The ethanol production cost decreases depending on the feedstock as sugarcane > corn grain > lignocellulose. The feedstock costs are 53 and 28% of the ethanol production costs from sugarcane and lignocellulose. Coproducts are sold when corn-grain is used as the feedstock, which reduces the overall ethanol production cost. Lignocellulose has the lowest feedstock cost, and research is in progress to reduce the cost

of cellulosic ethanol.^{264,268} The projected ethanol production costs do not include transportation, distribution, taxes, and other consumer costs. Ethanol production from lignocellulose currently requires a capital investment estimated to be \$0.28–0.63/annual-L.²⁶⁴ Included in Table 22 is the current cost of FOB spot price of diesel fuel with oil at \$57/bbl. This price on a per energy basis is about twice that of the ethanol production cost. (The cost of diesel fuel and gasoline are fairly similar.) Therefore, with oil at its current price, bioethanol is projected to be cost competitive with petroleum-derived fuel.

The fossil energy ratio (FER), defined as the fossil energy required for ethanol production divided by the energy in the ethanol, is shown in Table 22. The amount of fossil energy required to produce ethanol takes into account all fossil energy inputs in the ethanol life cycle including the energy required to grow the fertilizer, mine coal used as a fuel, plants the crops, harvest the crops, etc. The portion of the fossil energy ratio to grow corn is two times higher than the portion of the FER to grow sugarcane or lignocellulose because more fertilizer and irrigation is required to grow corn. The overall FER for ethanol production is dependent on the feedstock and decreases in the order corn grain \gg sugarcane $>$ lignocellulose. The reason for this large difference in FERs for ethanol production is that the biogas and lignin remaining after ethanol production can be burned to provide all of the process heat when sugarcane or lignocellulose are the feedstocks, respectively. However, when corn grain is the feedstock, fossil fuels are used to provide process heat. The fossil ratio of ethanol-derived corn grain depends on how energy credits are given for the various coproducts made during ethanol production. The largest use of fossil fuel energy during ethanol manufacture from corn grain results from the energy used during the fermentation–distillation process.

The U.S. media has reported some erroneous and outdated information regarding the fossil energy requirements for ethanol production from corn grain.¹⁷⁷ In the mid-1970s, most researchers concluded that the FER of ethanol production from corn grain was slightly greater than one. This means that the energy in the ethanol is less than the energy in the fossil fuel used to make it. As ethanol production in the U.S. grew, the ethanol production process improved, and the fossil energy requirements decreased.¹⁷⁷ In the last 16 years, all but one of the research groups who have done life cycle analysis for ethanol production from corn grains in the U.S. have concluded that ethanol contains more energy than the fossil energy inputs.¹⁷⁷ The only researcher in the last 16 years to claim that the fossil ratio in ethanol is greater than one is Pimentel.^{177,269} In the most up to date and thorough life cycle analysis, Sharpou et al. discussed how Pimentel used outdated information (from over 20 years ago) in his analysis.¹⁷⁷

The PTE for ethanol production ranges from 0.20 to 0.53 as shown in Table 22. The PTE for ethanol production from lignocellulose is similar to that of liquid fuels produced by fast pyrolysis of biomass followed by upgrading (Table 17) and higher than the PTE for alkanes by FTS of biomass-derived syn-gas (Table 9). However, the ethanol PTE is about half the PTE of diesel fuel production from crude oil. The LCTE, which also includes the energy to grow the biomass, for ethanol and diesel fuel production is also shown in Table 22.

Ethanol can be further converted into other fuels. For example, ethyl-tertiary-butyl-ether (ETBE) is produced by the reaction of ethanol with isobutylene. One of the concerns of ethanol as a gasoline blending agent is the high volatility of the ethanol–gasoline blend. ETBE can be blended with gasoline (up to 15 wt %). One of the advantages of ETBE is that it is less volatile than ethanol; however, ETBE may leak from gasoline stations causing groundwater contamination similar to MTBE.

8.2. Zeolite Upgrading of Sugars

Researchers at Mobil discussed the high energy requirements for ethanol distillation and tried to discover a more efficient method for biomass conversion.²⁷⁰ They passed concentrated sugars, including glucose, xylose, starch, and sucrose over ZSM-5 at 510 °C, 1 atm, and a WHSV of 2 and observed hydrocarbon, CO, CO₂, coke, and water as products as shown in Table 23. The addition of methanol to

Table 23. Products from the Reaction of Carbohydrates over ZSM-5 Catalyst^a

	xylose	glucose	starch	sucrose
products (wt %)				
hydrocarbons	10.0	8.2	8.9	4.4
CO	33.3	18.9	16.8	32.8
CO ₂	3.7	3.6	1.5	5.6
coke	16.8	24.9	30.4	23.8
H ₂ O	36.2	44.4	42.4	33.4
methanol feed weight ratio methanol/sugar 4:1				
products (wt %)				
hydrocarbons	18.6	19.0	7.9	7.9
CO	13.2	12.8	6.0	6.0
CO ₂	7.2	10.4	10.8	10.8
coke	16.6	14.0	28.7	28.7
H ₂ O	44.4	43.8	46.6	46.6

^a At 510 °C, 1 atm and WHSV = 2. From Chen et al.²⁷⁰

the feed stream decreased the amount of coke and increased the hydrocarbon products. The hydrocarbon products consisted of gaseous alkanes (methane, ethane, propane), liquid alkenes and alkanes (butene, pentene, hexane), and aromatics (benzene, toluene, C₈–C₁₀ aromatics). One of the problems with this reaction is that when methanol is not used 40–65% of the carbon is converted into coke. The thermal decomposition of glucose, which is not stable in the gas phase, probably produces most of this coke. The hydrogenated forms of sugars are more thermally stable and therefore would produce less thermal coke. Importantly, this shows that sugars can be converted to hydrocarbons by dehydration, decarbonylation, and decarboxylation reactions. Ideally, with this process, one molecule of glucose could be converted into 2/3 molecules of benzene, 2 molecules of CO, and 4 molecules of water as shown in eq 18. The oxygen in the sugar is converted into CO and water. The CO could also be converted into hydrogen by the WGS. This process has only been briefly studied at the benchtop, and no detailed current PTE is known.



8.3. Aqueous-Phase Processing

Dumesic and co-workers recently developed aqueous-phase catalytic processes (APP) for the conversion of sugars, sugar alcohols, and polyols into H₂ or alkanes ranging from

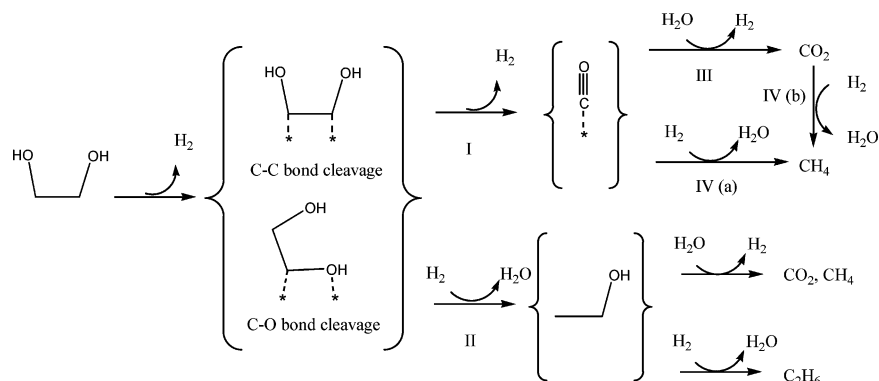

Figure 29. Reaction pathways and selectivity challenges for H_2 production from APR of ethylene glycol. Pathway I is desired C–C cleavage to form adsorbed CO. Pathway II represents undesired C–O cleavage followed by hydrogenation to produce ethanol, leading to formation of methane and ethane. Pathway III is the desired WGS reaction. Pathway IV represents undesired methanation and Fischer–Tropsch reactions to produce alkanes. (Figure adapted from Huber et al.²⁷⁵)

C_1 to C_{15} .^{18,22,25,115,159,160,271–273} Hydrogen, as well as CO_2 , CO, and light alkanes, are produced by aqueous-phase reforming (APR) of the sugar or sugar-derived feed with liquid water (eq 19) using a heterogeneous (solid) catalyst at low temperatures (200–260 °C) in the aqueous phase (10–50 bar). Virent Energy Systems is currently working to commercialize the APR process. One of the advantages of APR is that it produces a product H_2 gas with low levels of CO (100–1000 ppm)²⁷⁴ (making it ideal for PEM fuel cells) in a single reactor, whereas conventional steam reforming requires multiple reactors to reduce the CO levels.



The catalytic pathways for H_2 and CO_2 production by APR involves cleavage of C–C, C–H, and O–H bonds to form adsorbed species on the catalyst surface (Figure 29). Adsorbed CO species must be removed from the surface by the water–gas shift reaction to form CO_2 and H_2 because high surface coverages by CO lead to low catalytic activity. Undesired byproducts may arise from parallel and series pathways. Parallel reactions proceed via cleavage of C–O bonds followed by hydrogenation to give alcohols or by rearrangement reactions to form organic acids. Series reactions arise from hydrogenation of adsorbed CO and CO_2 to form alkanes. Thus, a good catalyst for production of H_2 by APR must facilitate C–C bond cleavage and promote removal of adsorbed CO species by the water–gas shift reaction, but the catalyst must not facilitate C–O bond cleavage and hydrogenation of CO or CO_2 .

The product selectivity is a function of the feed molecules, the catalyst, and the reaction conditions. Figure 30 shows the H_2 and alkane selectivity (primarily light alkanes, methane, and ethane are produced) as a function of feed molecule for APR of 1 wt % feeds with a $\text{Pt}/\text{Al}_2\text{O}_3$ catalyst.²⁵ As the size of the feed molecule increases, the H_2 selectivity decreases and the alkane selectivity increases. When the feed changes from sorbitol (hydrogenated glucose) to glucose, the H_2 selectivity decreases even more. Hydrogen can be made selectively by APR from aqueous feedstocks with high glucose concentration (10 wt %) in a two-reactor process where the first reactor (at 100 °C) hydrogenates the glucose to sorbitol, and the second reactor (at 200–265 °C) converts the sorbitol to CO_2 and H_2 .²⁷⁶ Hydrogen produced from the second reactor can be recycled for the hydrogenation reaction.

Reaction kinetic studies were conducted for the APR of ethylene glycol (a probe molecule for sorbitol) at low

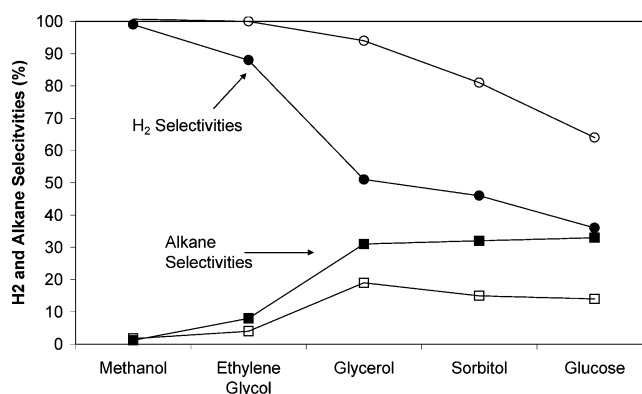
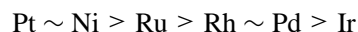

Figure 30. Selectivities versus oxygenated feedstock for aqueous-phase reforming of 1 wt % oxygenated hydrocarbons over 3 wt % $\text{Pt}/\text{Al}_2\text{O}_3$ at 498 K (open symbols) and 538 K (filled symbols). Key: H_2 selectivity (circles), alkane selectivity (squares), and EG: ethylene glycol. Figure adapted from Davda et al.¹⁶⁰

temperatures (483 and 498 K) and moderate pressures (22 bar) over silica-supported Ni, Pd, Pt, Ir, Ru and Rh catalysts. The overall catalytic activity for APR of ethylene glycol (as measured by the rate of CO_2 production per surface site at 483 K) decreases in the following order for silica-supported metals:²⁷²



Silica supported Rh, Ru, and Ni catalysts had low selectivity for H_2 production and high selectivity for alkane production. In addition, Ni/SiO_2 showed significant deactivation at 498 K. Thus, silica-supported Pt and Pd catalysts exhibited higher selectivity for production of H_2 , with lower rates of alkane production. The activity and selectivity of monometallic Pt-based catalysts can be improved further by supporting Pt on TiO_2 , carbon, or Al_2O_3 .²⁷⁷

A combination of high-throughput and fundamental studies was undertaken to develop better catalysts for APR. A high-throughput reactor was designed and built that allowed rapid screening of a large number of catalysts under APR conditions. More than 500 different mono- and bimetallic catalytic materials were screened using the high-throughput reactor, and inexpensive nonprecious metal catalysts and highly active precious metal catalysts were identified.^{271,278} The activity of Pt catalysts can be improved further by adding Ni, Co, or Fe to a $\text{Pt}/\text{Al}_2\text{O}_3$ catalyst.²⁷⁸ Alumina-supported PtNi and PtCo catalysts, with Pt/Co or Pt/Ni atomic ratios ranging from 1:1 to 1:9 had the highest turnover frequencies

for H₂ production (TOF_{H₂}, defined as moles of H₂ per mole of surface site counted by CO chemisorption) with values of 2.8–5.2 min⁻¹ for APR of ethylene glycol solutions at 483 K, compared to a value of 1.9 min⁻¹ for Pt/Al₂O₃ under similar reaction conditions. A Pt₁Fe₉/Al₂O₃ catalyst showed H₂ turnover frequencies of 0.3–4.3 min⁻¹ at 453–483 K, and these values are about 3 times higher than Pt/Al₂O₃ under identical reaction conditions.

Ni-based catalysts are active for APR; however, they have poor selectivity and stability. The H₂ selectivity of Ni-based catalysts can be improved by adding Sn to the Ni catalyst, and the stability of Ni catalysts can be improved by using a bulk Ni-catalyst (e.g., Raney Ni).^{271,275,279} Therefore, Raney-NiSn catalysts have good activity, selectivity, and stability for H₂ production by APR of biomass-derived oxygenated hydrocarbons. This inexpensive material has catalytic properties (activity, selectivity, and stability) that are comparable to those of Pt/Al₂O₃ for production of H₂ from small oxygenates, such as ethylene glycol, glycerol, and sorbitol. Rates of H₂ production by APR of ethylene glycol over R-NiSn catalysts with NiSn atomic ratios of up to 14:1 are comparable to 3 wt % Pt/Al₂O₃, based on reactor volume.

The addition of Sn to Raney Ni catalysts significantly decreases the rate of methane formation from series reactions of CO or CO₂ with H₂, while maintaining high rates of C–C cleavage necessary for production of H₂. However, it is necessary to operate the reactor near the bubble-point pressure of the feed and moderate space times to achieve high H₂ selectivities over R-NiSn catalysts, while it is impossible to achieve these high selectivities under any conditions over unpromoted R–Ni catalysts. The Sn-promoted Raney-Ni catalyst is catalytically stable for more than 250 h time on stream.²⁷⁹

According to Davda et al. the advantages of using APR to produce H₂ are¹⁶⁰

(1) APR eliminates the need to vaporize both water and the oxygenated hydrocarbon, which reduces the energy requirements for producing hydrogen.

(2) The oxygenated feedstock compounds of interest are nonflammable and nontoxic, allowing them to be stored and handled safely.

(3) APR occurs at temperatures and pressures where the water–gas shift reaction is favorable, making it possible to generate H₂ with low amounts of CO in a single chemical reactor.

(4) APR is conducted at pressures (typically 15–50 bar) where the H₂-rich effluent can be effectively purified using pressure-swing adsorption or membrane technologies, and the carbon dioxide can also be effectively separated for either sequestration or use as a chemical.

(5) APR occurs at low temperatures that minimize undesirable decomposition reactions typically encountered when carbohydrates are heated to elevated temperatures.

(6) Production of H₂ and CO from carbohydrates may be accomplished in a single-step, low-temperature process, in contrast to the multireactor steam reforming system required for producing H₂ from hydrocarbons.

The alkane selectivity can be increased by changing the catalyst and reaction conditions. Alkanes are produced by aqueous-phase dehydration/hydrogenation (APD/H) of sorbitol (eq 20) with a catalyst containing metal (e.g., Pt or Pd) and acid (e.g., SiO₂–Al₂O₃) sites to catalyze dehydration and hydrogenation reactions, respectively.¹¹⁵ Hydrogen is produced for this reaction by APR (eq 21). These two

reactions can be performed in a single reactor or two separate ones. The net reaction is exothermic, in which approximately 1.5 mol of sorbitol produce 1 mol of hexane (eq 22). The APD/H process occurs in the liquid phase, thereby eliminating the need to vaporize the aqueous feedstock and improving the overall thermal efficiency of the process. The alkanes produced, according to eq 17, retain approximately 95% of the heating value and only 30% of the mass of the biomass-derived reactant. This reaction pathway has one of the highest theoretical thermal efficiencies of any biomass conversion process. However, this process has only been studied at the benchtop and no detailed process analysis, with PTE, is available.

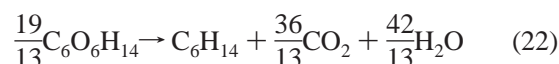
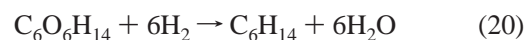

The alkane selectivity depends on the relative rates of C–C bond cleavage, dehydration, and hydrogenation reactions. The alkane selectivity can be varied by changing the catalyst composition, the reaction conditions, and modifying the reactor design.¹¹⁵ In addition, these selectivities can be modified by co-feeding H₂ with the aqueous sorbitol feed, leading to a process in which sorbitol can be converted to alkanes and water without the formation of CO₂ (since H₂ is supplied externally and need not be produced as an intermediate in the process). As another variation, the production of alkanes can be accomplished by replacing the solid acid with a mineral acid (such as HCl) that is co-fed with the aqueous sorbitol reactant.

One of the advantages of alkane production from biomass by APD/H is that the majority of the alkanes spontaneously separate from the aqueous feed solution, whereas ethanol produced during fermentation processes must be removed from water by an energy-intensive distillation step. It has been estimated that the overall LCTE for production of alkanes by APP from corn is double the energy efficiency for production of ethanol from corn.^{18,22} Alkanes produced by the APD/H of carbohydrates would provide a renewable source of transportation fuel that could fit into the current infrastructure. Unfortunately, the largest compound produced by APD/H of carbohydrates is hexane, which has a low value as a fuel additive because of its high volatility.

This limitation has been overcome by combining the APD/H process with a base-catalyzed aldol condensation step. This step links carbohydrate-derived moieties through formation of C–C bonds, to produce larger liquid alkanes ranging from C₇ to C₁₅.¹⁸ It should be noted that the C–O–C linkages (as found in disaccharides) are broken under APD/H reaction conditions. The aldol condensation process produces large organic water-soluble compounds derived from sugars. These molecules are then converted into alkanes in a specially designed four-phase dehydration/hydrogenation reactor. A conventional APD/H reactor cannot be used to produce alkanes from large water-soluble organic compounds, because extensive amounts of coke form on the catalyst surface (e.g., 20–50% of the reactant is converted to coke). Accordingly, to produce liquid alkanes the reactor system employed to carry out dehydration/hydrogenation reactions must be modified to a four-phase reactor system consisting of (i) an aqueous inlet stream containing the large

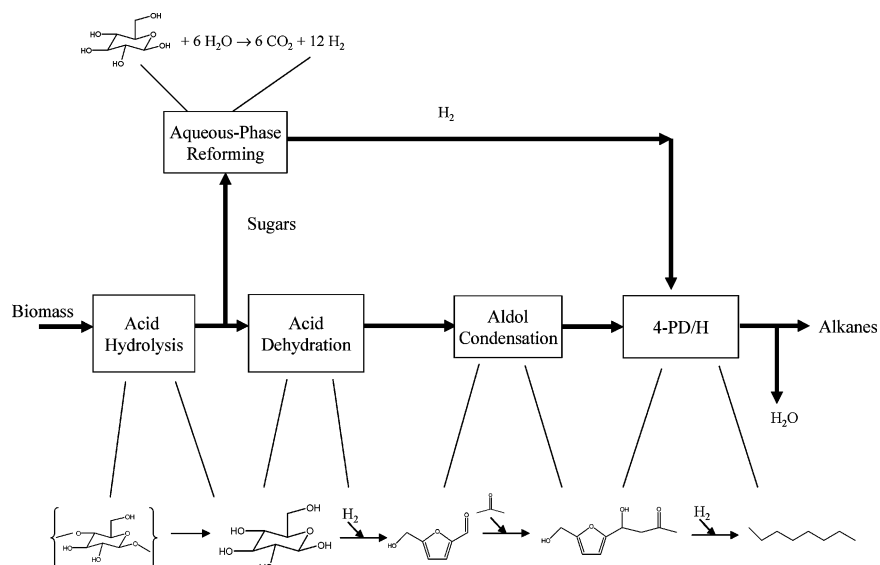

Figure 31. Self-sustaining biomass-refinery for conversion of biomass into liquid alkanes using aqueous-phase processing.

water-soluble organic reactant, (ii) a hexadecane alkane inlet stream, (iii) a H_2 inlet gas stream, and (iv) a solid catalyst ($\text{Pt}/\text{SiO}_2\text{-Al}_2\text{O}_3$). As dehydration/hydrogenation takes place, the aqueous organic reactants become more hydrophobic, and the hexadecane alkane stream serves to remove hydrophobic species from the catalyst before they react further to form coke. In an industrial setting, the alkanes produced from the reaction would be recycled to the reactor and used for the alkane feed. This process can also be modified to produce large oxygenated compounds that are soluble in diesel fuel.

Figure 31 shows a proposed biorefinery for converting biomass into liquid alkanes based on aqueous-phase processing. In the first step, cellulose and hemicellulose are respectively converted to xylose and glucose. Part of the sugar stream is then converted to H_2 by APR for use elsewhere in the plant. Furfural and HMF are produced from the remaining sugar stream by acid-catalyzed dehydration. Furfural and HMF are then condensed with acetone over a solid base catalysts to produce large water-soluble organic compounds. In the final reactor, a 4-PD/H, the condensed products are dehydrated and hydrogenated to produce large liquid alkanes (ranging from C_7 to C_{15}) over a bifunctional catalyst containing metal and acid sites.

Aqueous-phase processing, due to its high thermal efficiency and selectivities, appears to be a promising method for converting biomass-derived sugars into alkanes and H_2 . Other products can also be made by APP including oxygenated hydrocarbons, like large alcohols, which could be used for oxygenated fuels. Previous APP research has been used primarily with clean feeds, and future work should focus on using real biomass-derived feedstocks. The production of diesel fuel by APP requires that lignocellulose be converted selectively into HMF and furfural. Furfural can be selectively produced from xylose;²⁸⁰ however, HMF production from glucose is not currently possible with high yields. Future catalysts development work is needed to achieve more active and selective catalysts.

8.4. Supercritical Reforming of Sugars

Supercritical reforming of sugars can also produce H_2 as shown by eq 19.⁶⁹ Supercritical water conditions occur at conditions above the supercritical point of water (temperatures above 375 °C and pressures above 217 atm). Antal

performed thermodynamic calculations for the reforming of glucose at temperatures ranging from 200 to 800 °C and a pressure of 1 atm as shown in Figure 32.⁸¹ The products from the reaction include CO_2 , CO , H_2 and carbon (which they claimed represented tar). At temperatures of 300 °C, the equilibrium products are CO_2 , CH_4 , and carbon. As the temperature is increased, the carbon and CH_4 equilibrium decrease, and the CO and H_2 equilibrium increase. No carbon is obtained at temperatures above 600 °C. Experiments have shown that steam reforming of glucose (as well as fast pyrolysis oils and biomass) at atmospheric pressure produces large amounts of both thermal and catalytic coke. High reaction temperatures, above 600 °C, are needed to reform the coke.

Model showed that supercritical reforming of wood sawdust was able to produce gaseous products and avoid coke formation.^{70,71} Thus, supercritical reactions can be used to efficiently gasify glucose (and other biomass components) without coke formation. Figure 33 shows the results of supercritical gasification of glucose without a catalyst as a function of temperature, pressure, and concentration in capillary batch reactors.⁶⁹ The carbon efficiency is defined as the amount of carbon in the gas-phase divided by the carbon in the glucose. The product gas yield increased as the temperature increased. The reaction pressure had little effect on the product gas, while the glucose concentration had a significant effect. Increasing the glucose concentration decreased the yield of gas products.

Heterogeneous catalysts have been used in supercritical reactions and have been shown to greatly change the product selectivity. The Battelle single-step supercritical gasification reactor produces gas with high methane levels at temperatures around 350 °C and pressures 21 MPa with Ru and Ni bimetallic catalysts supported on TiO_2 , ZrO_2 and carbon.^{69,76} Higher reaction temperatures (600 °C and 34.5 MPa) for supercritical reactions have been able to produce H_2 from supercritical reforming of glucose.⁶⁹ Xu et al. showed that activated carbon is an efficient catalyst for supercritical gasification of glucose.⁷⁷ At a WHSV of around 20 h^{-1} close to 100% of the glucose feed was gasified with a molar composition of 22% H_2 , 34% CO , 21% CO_2 , 15% CH_4 , 6% C_2H_6 , and 2% C_3H_8 .

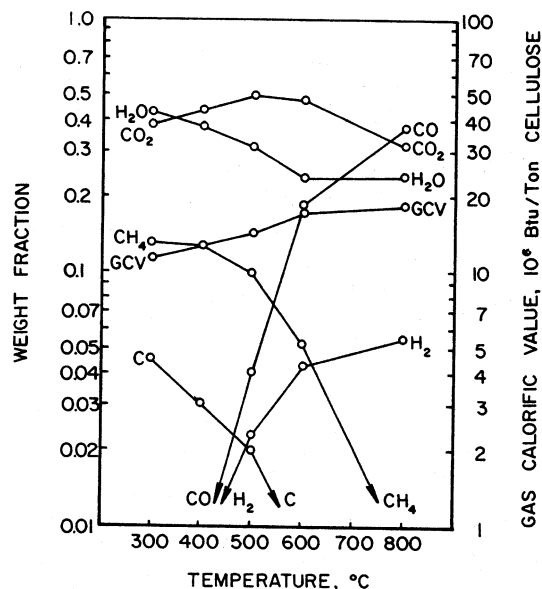

Figure 32. Thermodynamic calculations for reaction of glucose (1 mole) with water (7 mol) as a function of temperature at 1 atm. (Reprinted from ref 81 with permission. Copyright 1978 Institute of Gas Technology.)

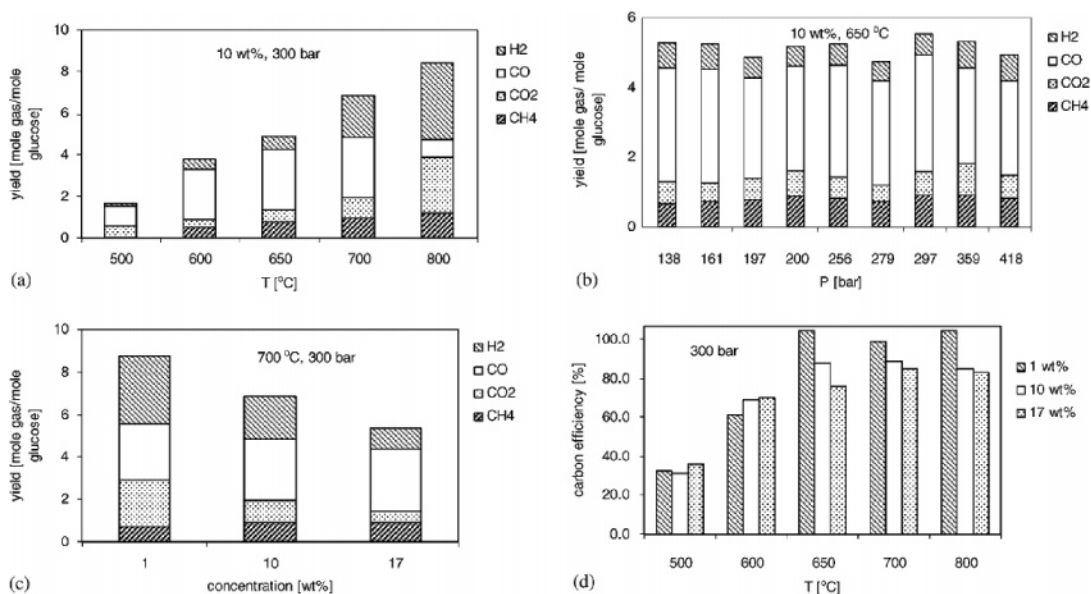

Figure 33. Products from supercritical reforming of glucose (without a catalyst) as a function of (a) temperature, (b) pressure, (c) concentration, and (d) concentration and temperature. Reprinted from ref 69 with permission. Copyright 2005 Elsevier.

Other biomass feedstocks including whole biomass can also be used for supercritical gasification (Section 3.4). The advantages of supercritical reforming are that high reaction rates are obtained, impure feedstocks can be used, wet feedstocks can be processed with high thermal efficiencies, product gas is produced in a single reactor, and the product gas is available at high pressure. The disadvantages of supercritical reforming are the high capital cost of high-pressure reactor, and H₂ only can be selectively produced at high temperatures where large amounts of CO are also produced. Supercritical reforming is an excellent way to produce product gases from aqueous biomass mixtures.

8.5. Biological Hydrogen and Methane Production

Sugars can be fermented to CH₄ or H₂ with fermentative microorganisms.² Methane is produced by methane fermentation or anaerobic digestion in the absence of oxygen with anaerobic bacteria. This same reaction takes place in the

ecosystem and in the digestive tract. Methane fermentation is used worldwide, for disposal of domestic, municipal, agricultural, and industrial biomass wastes. Carbon dioxide is also produced along with the methane in the gas.

Hydrogen can be produced by dark fermentation processes using anaerobic and facultative anaerobic chemoheterotrophs, which also produce acetic and butyric acids, as shown in eqs 22 and 23.^{2,281–283} Glucose, cellulose, starches, and a number of different waste materials can be used for hydrogen fermentation. As shown in eqs 22 and 23, the maximum amount of hydrogen that can be produced from these routes is 4 mol of H₂ per mole of glucose since acetic and butyric acids are formed, and theoretically 12 mol of H₂ could be produced from glucose. Reported yields of H₂ production range from 0.5 to 3.8 mol of H₂/mol of feed.²⁸² Hydrogen production is highly dependent on the pH, retention time, and gas partial pressure. The reaction is inhibited by hydrogen partial pressure, and to achieve high yields the H₂

must be diluted or long residence times are required. The organic acids produced must be sold or converted into other products, and higher yields of H₂ from glucose are possible with APR or supercritical reforming. The specific biological H₂ production rate ranges from 8 to 121 mmol of H₂ L⁻¹ h⁻¹.¹²⁷ A biological reactor of approximately 1000–15000 L would be necessary to provide enough H₂ to power a 5.0 kW PEMFC. Other processes can produce H₂, such as aqueous-phase reforming (5000–50000 mmol of H₂ L⁻¹ h⁻¹),¹⁵⁹ at higher rates. For fermentation technology methods to become commercially competitive they must develop methods to synthesis H₂ at higher rates. Optimization of bioreactor designs, rapid removal and purification of gases, and genetic modification of enzyme pathways offer exciting prospects for improving this technology.



9.0. Conversion of Nonsugar Monomers Derived from Lignocellulose

All components of lignocellulose should be utilized in fuel or chemical production in an integrated biorefinery. A number of non-carbohydrates can be selectively produced from lignocellulose, including lignin, furfural (from xylose), and levulinic acid (from cellulose). All of these compounds can be converted into fuels as discussed in this section.

9.1. Lignin Conversion

Lignin, which consists of coniferyl alcohol, sinapyl alcohol, and cumaryl alcohol polymers (Section 2.2), represents a major fraction of biomass (10–30 wt %) and is currently used as a low-grade fuel to provide heat in the pulp and paper industry. Designs of ethanol production in a lignocellulosic plant also show lignin being used to provide process heat.¹⁷¹ However, it would be ideal to convert the lignin into a higher value fuel or chemical. This would also require the development of alternative ways of providing process heat to the biorefinery or developing less energy intensive processes. Lignin can be used as a replacement for phenol-acetone resins, and other uses are being developed.²⁸⁴ Lignin also can be converted into a transportation fuel by dehydroxygenation or zeolite upgrading. These are the same methods used to upgraded bio-oils, which contain a large fraction of lignin products, discussed in Sections 6.1 and 6.2. Previous dehydroxygenation experiments of lignin feedstocks have used sulfided NiMo and CoMo catalysts supported on alumina, chromium, and zeolites at 250–450 °C.^{285–288} The major products from dehydroxygenation include phenols, cyclohexane, benzene, naphthalene, and phenanthrene with liquid oil yields of 61% the original lignin. It is likely that coking reactions occur under reaction conditions and deactivation due to water similar to what was observed by Delmon and co-workers for dehydroxygenation of guaiacol.^{217–219} The reactions that occur during dehydroxygenation include hydrogenation of C=C bonds, hydrogenation of aromatics, and deoxygenation of C–O bonds. Future work in this area should focus on the development of nonsulfided catalysts, since sulfur is not present in the feed in large concentrations.

Thring et al. studied zeolite upgrading of lignin with HZSM-5 catalyst at 500–650 °C and 2.5–7.5 h⁻¹ WHSV.²⁸⁹

Table 24. Zeolite Upgrading of Lignin with ZSM-5 Catalyst^a

temperature (°C)	500	550	600	600	600	650
WHSV (h ⁻¹)	5	5	2.5	5	7.5	5
yield of products (%)						
gas	11	19	51	54	58	68
liquid	39	43	34	30	22	11
char + coke	50	38	15	16	20	21
major liquid product (wt %)						
benzene	8.6	9.4	9.3	13.6	14.5	14.4
toluene	33.1	36.7	31.0	42.4	41.9	43.7
xylene	31.5	33.0	25.0	22.7	24.8	21.0
ethyl benzene	3.0	2.1	2.2	1.9	1.5	1.3
propyl benzene	4.2	2.5	3.7	1.3	1.5	1.0
C ₉₊ aromatics	9.0	5.1	6.4	6.0	3.1	3.0
gas composition (wt %)						
methane	8.7	5.3	13.0	4.4	8.3	13.9
ethylene	6.6	19.5	14.7	16.2	19.1	24.3
ethane	4.5	2.6	4.5	2.8	2.6	2.9
propylene	8.2	21.1	8.9	11.4	14.1	13.4
propane	34.6	13.7	4.5	6.6	4.8	2.6
C ₄	18.5	13.2	2.9	4.4	5.0	3.0
C ₅₊	4.8	2.4	1.6	1.0	1.9	3.9
CO	3.1	9.4	22.0	23.5	23.9	6.6
CO ₂	10.9	12.4	27.7	29.7	20.1	19.6
H ₂	0.2	0.3	0.1	0.1	0.3	0.1

^a Adapted from Thring et al.²⁸⁹

Table 24 shows the results of this study. The highest liquid yield was 43%, and the coke and char yields were 15–50%. As the temperature increased gas yields increased, char and coke yields decreased, and liquid yields decreased. The major liquid components are toluene, benzene, and xylene.

Joseph Shabtai and the NREL designed a process to convert lignin into a high-octane-oxygenated gasoline additive as shown in Figure 34.^{290,291} The first step in this

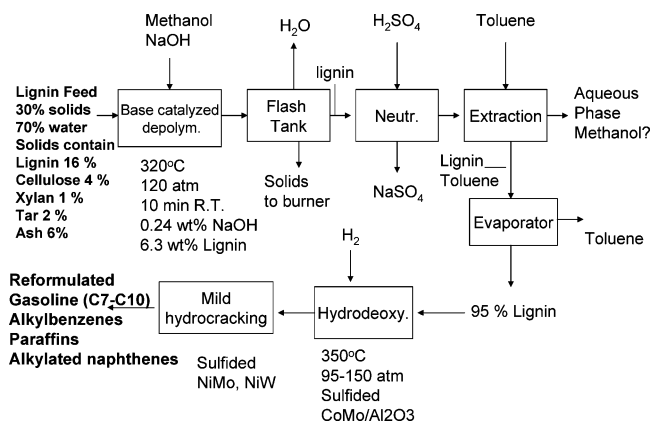

Figure 34. Process for production of gasoline from lignin by base-catalyzed depolymerization of lignin followed by hydrotreating developed by Shabtai and NREL.^{290,291}

process involves base-catalyzed depolymerization with NaOH at 320 °C and 120 atm of a 30% solids feedstock consisting of lignin, water, ash, tar, and some cellulose with methanol or ethanol at alcohol to lignin weight ratios of 3:1 to 5:1.^{290,292} The alcohol helps maintain supercritical conditions, which help solubilize the lignin. The depolymerization steps break down the lignin into monomer units. The products then go to a flash tank where some of the water and the solids are removed. The insoluble solids are sent to a boiler or sold as boiler fuel. The liquid products are neutralized with sulfuric acid, and the lignin is extracted in a toluene stream.

The lignin, which contains mono-, di-, and polyalkyl substituted phenols and benzenes with minor amounts of alkoxyphenols and alkoxybenzene, is then separated from

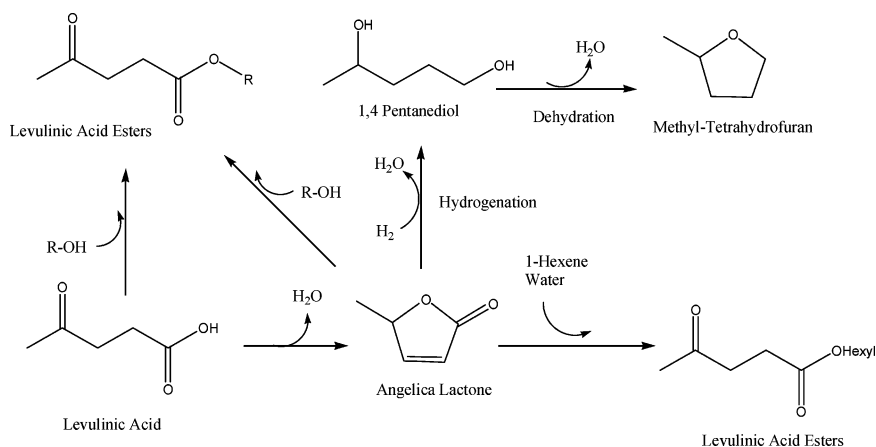

Figure 35. Pathways for production of fuels from levulinic acid.

the toluene stream and fed to the hydroprocessing unit. Hydrotreating consists of two reactors for hydrodeoxygenation and hydrocracking/ring hydrogenation. The catalysts for these reactors are sulfided NiMo or CoMo catalysts. The products consists of C₇–C₁₁ alkylbenzenes, C₅–C₁₁ multi-branched paraffins, and mono-, di-, tri-, and polyalkylated cyclohexanes and cyclopentanes. The products are 65% aromatics with an octane number of 100–110. The production cost of the high octane reformulated fuel additive, assuming 100% solubilization of the lignin, and a 70% overall yield, is estimated to be \$0.28/L. Alternatively, the depolymerized lignin could be converted into aryl methyl ethers (mostly phenyl-, tolyl-, and dimethylphenyl methyl ethers) by feeding the depolymerized lignin to a reactor for a mild selective C–C hydrocracking treatment, to completely depolymerize the lignin to monocyclic phenols, and then etherification of the phenols with methanol.²⁹³ Hydrocracking catalysts include Pt/SO_x/ZrO₂ or Pt/WO_x/ZrO₂. Solid acids, such as SO_x/MnO_x/Al₂O₃, SO_x/MoO_x/Al₂O₃, and SO_x/WO_x/Al₂O₃ are used for the etherification step.

9.2. Levulinic Acid Conversion

Levulinic acid can be converted into fuels by dehydration/hydrogenation or esterification as shown in Figure 35. Methyl tetrahydrofuran (MTHF), which has an octane number of 87 and can be blended with gasoline up to 70%, can be produced by a dehydration/hydrogenation pathway of levulinic acid. MTHF (20 wt % oxygen content) can increase the oxygen content of gasoline and has been approved by the USDOE as a component of P Series fuel. Levulinic acid is separated from other reaction products (water, formic acid, and furfural) by vacuum distillation at 160 °C and 10–50 mmHg to produce angelica lactone (the dehydration product). This reaction is reversible, and water addition will promote levulinic acid formation. Hydrogenation of angelica lactone with PdRe/carbon catalysts at 200–250 °C and 100 atm H₂ produces first γ -valerolactone and then 1,4-pentanediol, which dehydrates to form MTHF in yields up to 90%.²⁹⁴ 1-Pentanol and 2-pentanol are also produced in this process in lower yields.

Reaction of angelica lactone with an alcohol in the presence of an acid or base catalyst yields levulinic esters.²⁰ The base-catalyzed reaction is carried out at 100–150 °C, 55 atm N₂, and with organic (Et₃N), homogeneous (e.g., Na₂CO₃, K₂CO₃) or supported oxide (e.g., MgO/SiO₂, LiO/SiO₂) basic catalysts. The choice of catalyst depends on the alcohols used. Levulinic esters have a high octane number and a high

Table 25. Fuel Characteristics of Levulinic and Formic Acid-Derived Fuels and Comparison to MTBE^a

compound	O ₂ content (wt %)	required wt % for 2.7 wt % O ₂ oxygenated gasoline	vapor pressure at 38 °C (kPa)	blending octane no. (R + M)/2
MTBE	11	14.9	55	109
methyl formate	3.8	5.1	126	102
ethyl formate	4.6	6.3	55	103
methyl levulinate	37	7.3		106.5
ethyl levulinate	33	8.1		107.5
isopropyl levulinate	30	8.9		105
isobutyl levulinate	28	9.7		102.5
sec-butyl levulinate	28	9.7		102.5

^a Adapted from Fagan et al.²⁹⁷

oxygen content (Table 25) making them ideal for gasoline fuels additives. The oxygen content of levulinic esters is significantly higher than the oxygen content of MTBE, and therefore oxygenated gasoline requires less levulinic ester than MTBE. Diesel fuel can be oxygenated by the addition of levulinic esters.²⁹⁵ Levulinic esters also can be produced by reaction of angelica lactone with olefins at 100–150 °C, 55 atm N₂, and with homogeneous and solid acid catalysts.²⁹⁶ A mixture of levulinic and formic acid can produce levulinic and formic esters by reaction with olefins;²⁹⁷ therefore, levulinic and formic acid do not need to be separated prior to the reaction. Formic esters can be used as fuel additives. Leo Manzer of Dupont has estimated that levulinic esters could be produced on a large scale at less than \$0.50/L.¹⁹

9.3. Furfural Conversion

Furfural, 2-furaldehyde, is the triple dehydration product of xylose and is an important chemical obtained from the hemicellulose biomass fraction. Industrially, more than 300 000 metric tons/year of furfural are produced.²⁹⁸ Furfural is currently too expensive for use as a fuel; however, future production of furfural in an integrated biorefinery where all fractions of biomass are used could significantly decrease the cost. The Quaker Oat Company in 1922 developed the first commercial process for production of furfural from oat hulls using acid catalyst.²⁹⁹ During the production of furfural, superheated steam passes through a reactor containing the biomass to provide heat for the reaction and remove the furfural product. Furfural is reactive under these conditions, so it is vital to remove the furfural before it undergoes

undesired reactions. Typical reaction conditions for furfural production are 3 wt % sulfuric acid, 2:1 to 3:1 acid solution to lignocellulosic mass ratios, 170–185 °C, and 3 h retention time.²⁹⁸ Sulfuric acid is not necessary if the temperature is raised high enough. This is because acetic acid in the hemcellulose reaction is released and can catalyze the dehydration reaction.²⁹⁹ Typical furfural yields are around 45–50%.²⁹⁸ Higher yields of up to 60% can be obtained by acid-catalyzed dehydration of pure xylose.³⁰⁰ According to Zeitsch, the principle yield loss of furfural is due to reactions between furfural and xylose, and by eliminating this problem by proper reactor design, significantly better yields can be obtained.^{280,301} Another new method, tested at the pilot-plant scale, appears to be promising for producing furfural at yields as high as 70%. This method involves using a continuous tubular reactor at high temperature (250 °C), short residence time (5–60 s), acid concentrations from 0.3 to 2.0 wt %, and steam injection to rapidly remove the furfural.²⁹⁸ Current furfural reactors are expensive to operate due to the large quantities of steam (30 to 50 times the amount of furfural produced) and lengthy reaction times.^{280,301} Typical yields of furfural, based on current commercial technology, on a weight basis for feedstocks (kg of furfural/kg of feedstock) are 0.22 for corncobs, 0.12 for bagasse, 0.17 for cornstalks, 0.16 for sunflower hulls, and 0.16 for hardwoods.²⁹⁸

The mechanism for formation of furfural from xylose appears to go through a 2,5-anhydride intermediate.³⁰⁰ Furfural can also be produced from xylose using heterogeneous catalysts including MCM functionalized sulfonic acid catalysts,³⁰² heteropolyacids,³⁰³ faujasite, and mordenite.³⁰⁴ High yields of furfural, up to 75%, are obtained with heterogeneous catalysts in DMSO and toluene/water solvents;³⁰² however, the yield is significantly lower (less than 30%) when water is used as a solvent.

Furfural by itself can not be used as a motor fuel because of its tendency to polymerize.³⁰⁵ However, as shown in Figure 36, furfural can be hydrogenated to furfuryl alcohol,

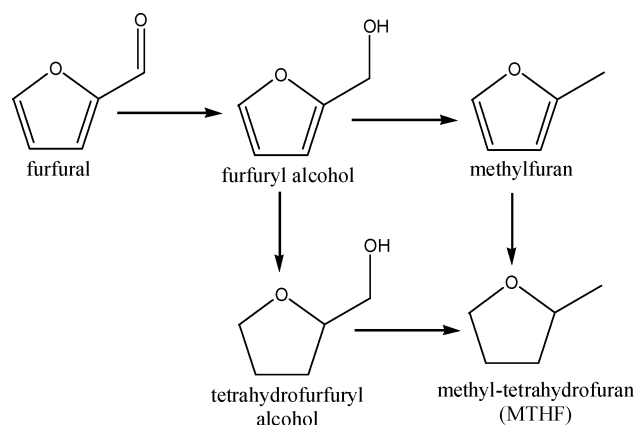

Figure 36. Pathways for hydrogenation of furfural.

methyl furan, tetrahydrofurfural alcohol, and methyltetrahydrofuran (MTHF), which according to Bayan have octane number of 83, 74, 83, and 74, respectively.³⁰⁵ The octane number of furfural is 53. Of the hydrogenated forms of furfural, only MTHF is suitable as a motor fuel because it will not polymerize and has a low volatility.³⁰⁵ As mentioned previously, MTHF, which also can be derived from hydrogenation of levulinic acid, is approved by the USDOE for use as a gasoline additive in P Series type fuels. Ahmed developed a two-step process to produce MTHF from

furfural.³⁰⁶ The first step involved hydrogenation of furfural to 2-methylfuran over a Cu-based catalyst at 175 °C, followed by hydrocarbon of 2-methylfuran to MTHF with a Ni-based catalyst at 100 °C. Furfural can also be used to produce liquid alkanes (*n*-C8 to C13) by aqueous-phase processing as discussed in Section 8.3.

10.0. Triglyceride Conversion

Triglycerides are the major component of vegetable oils and animal fats (Section 2.3). They also can be produced from aquatic biomass such as algae (Section 2.4). Vegetable oils can be used directly in diesel engines; however, there are a number of disadvantages of pure vegetable oils, including high viscosity, low volatility, and engine problems (including coking on the injectors, carbon deposits, oil ring sticking, and thickening of lubricating oils).^{34,307} These problems require that vegetable oils be upgraded if they are to be used as a fuel. The most common way of upgrading vegetable oils to a fuel is transesterification of triglycerides into alkyl-fatty esters (bio-diesel). Waste vegetable oils, like frying oils, can be used as feedstocks; however, changes in the process need to be made as waste vegetable oils contain free fatty acid (FFA) and water impurities. Vegetable oils can also be blended with diesel fuel or upgraded by other methods including zeolite upgrading and pyrolysis.

10.1. Transesterification

Transesterification is the reaction of triglycerides (or other esters) with alcohols to produce alkyl esters (biodiesel) and glycerol, typically in the presence of acid or base catalysts as shown in Figure 37. Methanol, due to its low cost, is the alcohol most commonly used, although other alcohols including ethanol or 2-propanol can produce biodiesel with better fuel characteristics. Ethanol is used to produce biodiesel in Brazil because of inexpensive ethanol sources. Alkyl esters or biodiesel are also called fatty acid methyl esters (FAME). Alkyl esters can be used directly in diesel engines with minor engine modifications, and they are sold in the U.S. as a fuel called B100. Alkyl esters can be blended with traditional diesel fuel in up to 20 vol %, with no engine modification. Blends of alkyl esters and diesel fuel are sold as a fuel termed B1–20 ranging from 1 to 20 vol % biodiesel. Biodiesel is soluble with petroleum diesel at all levels. Reviews of alkyl ester production are published elsewhere.^{34,307,308}

Transesterification consists of a number of consecutive, reversible reactions, with diglycerides and monoglycerides as intermediates (Figure 37).³⁰⁹ The first step in transesterification is production of diglycerides and alkyl esters, followed by monoglycerides and alkyl esters, and finally alkyl esters and glycerol. All of these reactions are reversible, and excess alcohol solvent is used (typically 50–200% excess alcohol) to drive the reaction to completion with yields of alkyl esters as high as 99.7%. The alkyl esters also separate from the alcohol-catalyst phase during the reaction, further decreasing the reverse reaction rate.

The first step in the reaction mechanism for base-catalyzed transesterification involves reaction of the base with methanol to produce an alkoxide species, as shown in Figure 38.³¹⁰ The alkoxide then reacts with the triglyceride to form a tetrahedral intermediate. This intermediate then decomposes to form an alkyl ester and the corresponding anion of the diglyceride. This step is followed by the deprotonation of

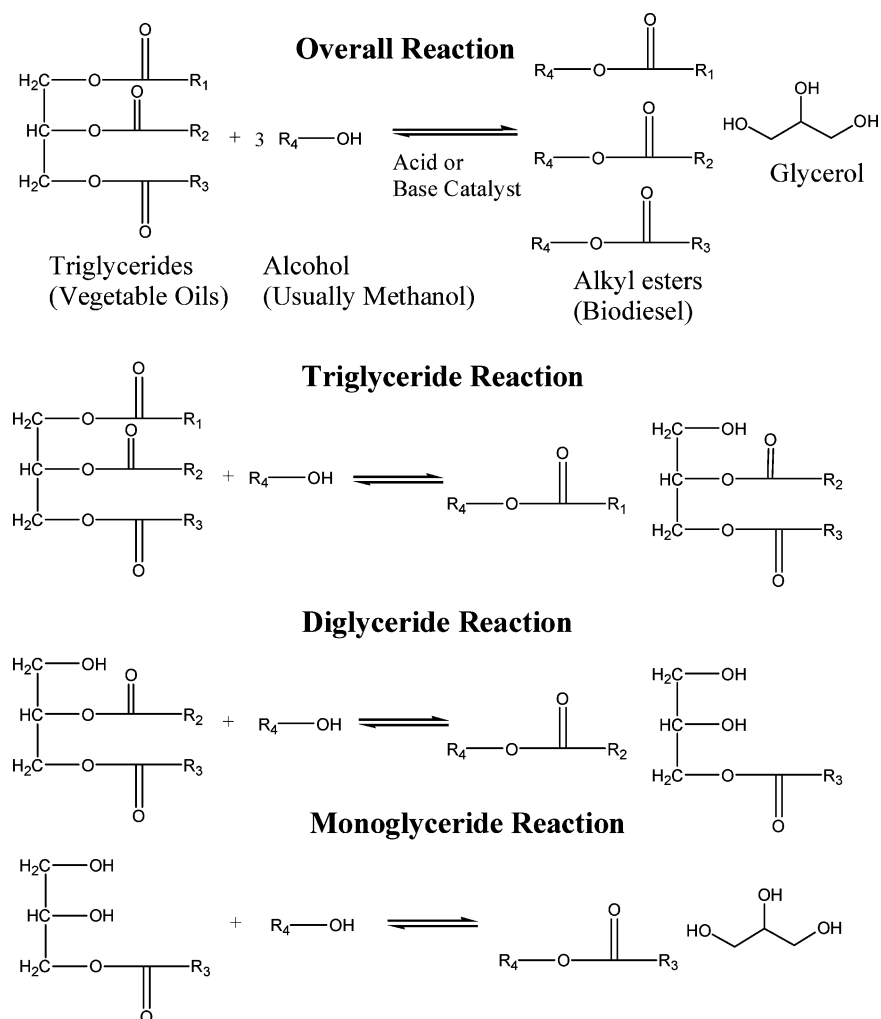

Figure 37. Overall and intermediate reactions for transesterification of triglyceride and alcohol to produce alkylesters (biodiesel) and glycerol.

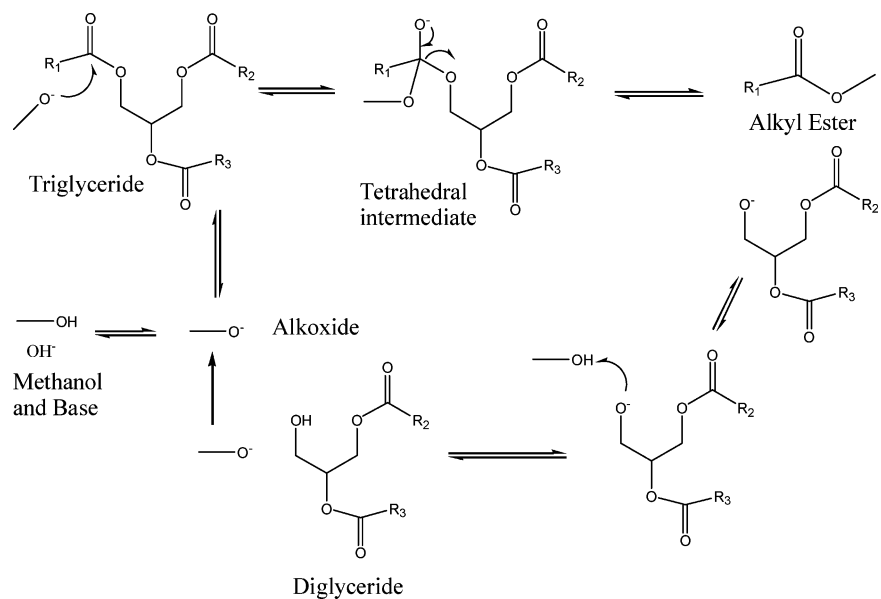

Figure 38. Mechanism for base-catalyzed transesterification of triglycerides adapted from Schuchardt et al.³¹⁰

methanol by the diglyceride anion regenerating the alkoxide species. Diglycerides and monoglycerides are converted by this same mechanism into alkyl esters and glycerol.

Freedman and co-workers observed second-order reaction kinetics for all three reversible reactions (triglycerides to

diglycerides, diglycerides to monoglycerides, and monoglycerides to esters) in the transesterification of soybean oil with butanol and methanol.³⁰⁹ Triglycerides only have a limited solubility in methanol, so it is difficult to measure the reaction rate. Mechanically mixing of the two phases is important

for improving the mass transfer between the two phases.³¹¹ The addition of solvents that increase the solubility of methanol and triglycerides, such as tetrahydrofuran (THF), can significantly increase the reaction rate.³¹² Water has a negative effect on the reaction because alkyl esters, triglycerides, diglycerides, and monoglycerides can react with water to form free fatty acids (FFA) (eq 25). FFAs react with base catalyst to form soap, which causes downstream problems such as plugging, gel formation, an increase in viscosity, and problems with production separation.



Both acid and base catalysts can be used for transesterification; however, base catalysts are 4000 times more active and cause fewer corrosion problems than do acid catalysts. Most biodiesel processes use mineral acid catalysts for esterification of FFA and alkali base catalysts for transesterification including sodium hydroxide, potassium hydroxide, and sodium methoxide. Sodium methoxide is the most widely used biodiesel catalyst with over 60% of industrial plants using this catalyst.³⁰⁸ The most active and expensive catalyst is also sodium methoxide.

Research is ongoing to develop heterogeneous and enzymatic catalysts for esterification and transesterification because removal of homogeneous catalysts requires further downstream processing, increasing bio-diesel production cost. Heterogeneous catalysts have the advantage that they can be easily removed from the product and recycled, and current research indicates a number of promising heterogeneous catalysts for biodiesel production.^{313–317} Problems with current heterogeneous catalysts are that they are not as active as homogeneous catalysts, and they require higher reaction temperatures (200–250 °C) and pressures.³⁰⁸

The patent and academic literature lists a number of solid acid and base heterogeneous catalysts that have been used for transesterification.³⁰⁸ It should be taken into account that the presence of FFA in the feed will strongly poison solid catalysts. Thus, special care should be taken to remove FFA before they encounter the fixed-bed reactor containing the solid/base catalyst. Alternatively, researchers have focused on the development of solid acid catalysts for the transesterification reaction and/or to eliminate FFAs. The Institut Francais de Petrole developed a heterogeneous catalyst, which was a mixture of ZnO, Al₂O₃, and ZnAl₂O₄, for transesterification of vegetable oils with methanol at 230 °C and 50 atm.³¹⁸ Lopez et al. studied the transesterification of triacetin with methanol on a range of solid acid and base catalysts including ETS-10 (Na, K), SO_x/ZrO₂, WO_x/ZrO₂, MgO, Nafion, β-zeolite, and phosphoric acid/silica.³¹³ The most promising catalysts were Amberlyst, Nafion, SO_x/ZrO₂, WO_x/ZrO₂, and ETS-10(Na, K). However, leaching of Na occurred with ETS-10 catalyst, whereas the deactivation rate for WO_x/ZrO₂, Nafion, and amberlyst was small. WO_x/ZrO₂ and SO_x/ZrO₂ had activities on a per-site basis similar to H₂SO₄. However, these catalysts are less active on a mass basis than sulfuric acid because they do not have the same number of sites. Toda et al. developed sulfonated catalyst supported on carbonized saccharides.³¹⁴ They claim that the activity of this catalyst is more than half that of liquid sulfuric acid and higher than conventional solid acid catalysts.

Cantrell et al. studied the initial activity of mixed Mg–Al-oxide catalysts, derived from hydrotalcite, for transes-

terification reaction of methanol with glyceryl tributyratate at room temperature and found the catalyst with the highest activity had a 24 wt % Mg loading.³¹⁶ Suppes et al. studied the transesterification of soybean oil with methanol at 60–120 °C with NaX faujasite zeolite, ETS-10, and metal catalysts, with ETS catalysts being the most active.³¹⁷ Kim et al. developed a Na/NaOH/Al₂O₃ that had activity similar to NaOH catalysts for transesterification of vegetable oils; however, they did not recycle the catalyst, indicating concerns about catalyst stability.³¹⁵ Development of future highly active, selective, and stable heterogeneous catalysts for transesterification reaction promises to decrease the biodiesel production cost and will be an increasing important research area in the future.

Solid base catalysts are used for very similar reactions such as the glycerolysis reaction of vegetable oils and glycerol to produce monoglycerides at 240 °C.³¹⁹ Corma and co-workers studied this reaction and showed the order of catalytic activity decreased as MgO > Mg–Al-oxide > Sepiolite-CS > MCM-41-Cs. These authors demonstrated that these catalysts could be recycled without a significant loss in activity. Solid Bronsted base catalysts have significantly higher activity than Lewis base catalysts for transesterification of oleic acid methyl esters with glycerol.³²⁰ Efforts have been made to synthesize layered mixed solids (Mg/Al hydrotalcites) with controlled crystallite size and large accessible surface areas.³²¹ This has been shown to increase catalyst activity for transesterification reactions.

Lipase, enzymatic catalysts, can also catalyze esterification reactions. The advantages of lipase catalysts are their ability to catalyze both transesterification and esterification of FFA in one step, production of glycerol side stream with minimal water content and little or no inorganic material, and recyclability.³⁵ However, enzymatic catalysts have high costs and deactivate due to feed impurities.

At high pressure (120 atm) and temperature (350 °C) triglyceride transesterification occurs without any catalyst.³²² Some production plants in Europe use this technology; however, this requires high pressure leading to an increased capital cost.³⁵ Advantages of this method are that the esterification reaction can occur rapidly (less than 5 min),³²³ and no catalyst is required decreasing downstream processing costs.

A block flow diagram for production of biodiesel from vegetable oils is shown in Figure 39.³¹² The first step in the process is transesterification of the refined vegetable oils

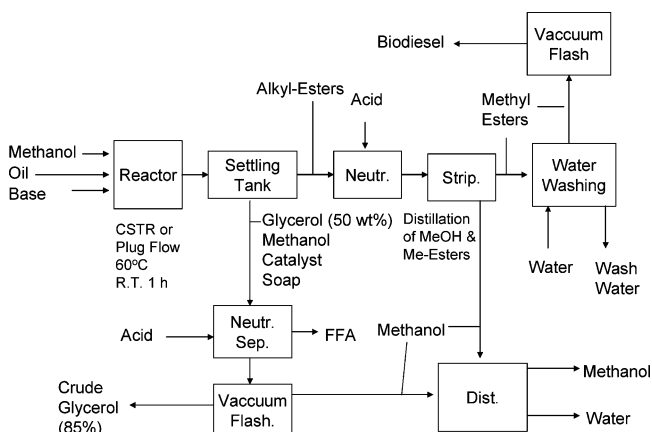

Figure 39. Block flow diagram for biodiesel production by transesterification of vegetable oils adapted from Van Gerpen and Knothe.³¹²

(refined by crushing of vegetable seeds) with methanol and a base catalyst in a CSTR or plug flow reactor at 60 °C, approximately 1 atm, 6:1 methanol/oil molar ratio and 1 h residence time. Sometimes the transesterification process is carried out in two different CSTRs where approximately 80% of the catalyst and methanol is added to the first reactor. In the second reactor, the remaining alcohol and catalyst is added. The two-step process has the advantage of using less methanol than a single step process.

The products from the reactor are in two phases: a glycerol-rich phase and a methyl ester-rich phase. A settling tank and centrifuge separates the two phases. The glycerol stream contains approximately 50 wt % glycerol, most of the base catalyst, and most of the soap. This fraction is then neutralized with acid, and the soap forms FFAs, which phase separate from the glycerol stream. The FFAs can be recycled and used for biodiesel production. A vacuum flash process separates the methanol and glycerol phases, with a 85 wt % glycerol product, which is then sold.

The methyl ester-rich stream, which also contains 2–3 wt % methanol, a small amount of base, and small amounts of di- and monoglycerides, is neutralized prior to methanol removal. The acid removes any remaining catalyst or soap. The methanol in the methyl ester stream is then stripped by vacuum flash or a falling film evaporator. Water washing of the methyl ester stream removes salts and FFA. Any remaining water in the biodiesel is removed during a final drying step in a vacuum flash process. Water is also removed from the methanol stream, and the remaining methanol can be recycled to the process.

Waste triglycerides oils, such as cooking oils (2–7 wt % FFA) and animal fats (5–30 wt %), contain significant amounts of FFA.³¹² If base catalysts are used for the transesterification process, then the FFA will react with the base catalyst forming soap according to eq 26. Soap causes downstream processing problems including gel formation, viscosity increases, and product separation difficulty.³⁴ Freedman et al. have recommended that the concentration of FFA in the oil should be less than 0.5 wt %; otherwise, the FFA will react with base catalysts to form soap and water.³²⁴ Free fatty acids can be removed from vegetable oils by an acid-catalyzed esterification treatment where the FFA react with methanol to form methyl esters and water. Two phases are present in this reaction: a methanol phase that contains water, acid and some oil and a triglyceride phase that contains triglycerides, methyl esters, and unreacted FFA. Solid acid heterogeneous catalysts also catalyze the reaction of FFA with methanol.³²⁵

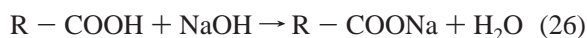

Bray analyzed the economics of biodiesel production using two different processes: the CD process which consists of transesterification in three packed column reactors in series and an alkaline catalyzed process from Lurgi PSI where the transesterification reaction occurs in two agitated reactors in series.³⁰⁸ The Biodiesel production costs are made up of three major components: feedstock costs, capital costs, and byproduct credits. As shown in Table 26, the biodiesel feedstock (soybean oil, methanol, and catalyst) is the single largest cost for biodiesel production representing over 70% of the biodiesel cost in this analysis. The refined production cost of biodiesel (\$0.49–0.50/L) is close to the feedstock costs (\$0.46–0.47/L) because glycerol currently has a high value (\$1.10–2.20/kg for refined glycerol), which Bray

Table 26. Biodiesel Production Cost for a Plant with Capacity of 99790 Metric Tons Per Year and Soybean Oil Cost of 49¢/kg^a

production cost (¢/L)	CD process	alkaline process
raw materials	46.34	47.71
by products	−10.21	−10.41
utilities	0.78	0.63
total variable costs	36.90	37.94
labor (operating, maintenance & control)	2.21	2.06
maintenance materials	0.70	0.49
operating supplies	0.13	0.13
total direct costs	39.95	40.60
plant overhead	1.77	1.65
taxes and insurance	0.97	0.72
total plant cash costs	42.68	42.98
depreciation, 12-year life, 8.33%/year	4.06	3.04
plant gate costs	46.74	46.02
G&A, sales, research, 5% PV	3.11	2.91
net production cost (per L)	49.85	48.92
ROI before taxes 25%/year TFC	12.15	9.06
product value (PV)	62.08	57.99

^a Adapted from Bray.³⁰⁸ The current diesel fuel FOB spot price at New York Harbor is 44¢/L, and oil prices are \$57/bbl.¹⁴

assumed was \$1.21/kg. It has been projected that increased biodiesel production will significantly decrease glycerol prices. Bray estimates that the refined glycerol price could drop to \$0.77/kg, which would decrease the credit given for glycerol production to \$0.07/L. Haas et al., who also modeled the biodiesel production cost, had similar economic results as those of Bray.³²⁶ Haas et al. estimated the biodiesel production cost to be \$0.53/L when the feedstock soybean cost was \$0.52/kg, and with a glycerol credit of \$0.33/kg for an 80 wt % glycerol–water solution.

The FOB cost of diesel fuel from crude oil is 44¢/L when oil prices are \$55/bbl.⁹ Thus, biodiesel is currently slightly more expensive than petroleum diesel. However, biodiesel can be cost competitive with petroleum-derived diesel fuel, in many countries, if it is exempt from taxes. In the EU, the tax on diesel ranges from \$0.34–0.99/L, which is higher than the tax in the U.S. of \$0.13/L.

Since feedstock is the primary cost of biodiesel, decreasing the feedstock cost will significantly decrease the biodiesel cost. Figure 40 shows the cost of biodiesel from cheaper

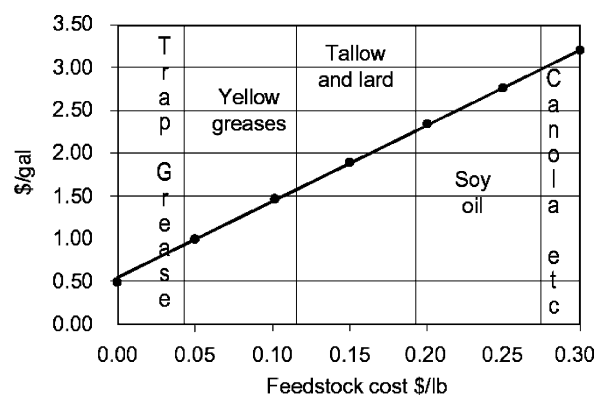

Figure 40. Biodiesel production cost as a function of feedstock cost (1 gal = 3.79 L, 1 lb = 0.454 kg) from Schumacher et al.³²⁷ (Reprinted from ref 327 with permission. Copyright 2004 Elsevier.)

feedstocks. The feedstock costs decrease from canola oil > soy > tallow and lard > yellow grease > trap greases. Yellow grease is produced from used cooking oil and other fats collected from restaurants, cafeterias, and other commercial cooking industries. Yellow greases today is used as

an ingredient in animal feeds; however, concerns about Mad Cow disease caused a ban on it for use as an animal feed.³⁰⁸ Processing of yellow grease is more expensive than vegetable oils because yellow grease has higher FFA levels. Trap grease or brown grease is collected from grease traps in sewage plants. Trap grease contains high levels of water, FFA, and other impurities.

A life cycle wells to wheel analysis for biodiesel and petroleum diesel has been done by Sheehan et al., and the results, in terms of fossil energy ratio (FER), PTE, and LCTE are shown in Table 27.³²⁸ Biodiesel and petroleum diesel

Table 27. Fossil Energy Ratio and Thermal Efficiencies for Production of Diesel Fuel and Biodiesel from Oil and Soy, Respectively^a

	petroleum diesel	biodiesel from soybean
fossil energy ratio (MJ _{fossil fuel} /MJ _{product})		
crude production	1.113	0.149
crude transport	0.016	0.034
refining	0.064	0.151
refined transport	0.006	0.004
overall energy requirements	1.199	0.311
process thermal efficiency	0.94	0.93
life cycle thermal efficiency	0.83	0.80

^a Data from Sheehan et al.³²⁸ Energy of lignocellulose is not taken into account for calculating thermal efficiencies of biodiesel.

require similar amounts of fossil fuel for production, refining, and transport when the energy content of the final diesel fuel product is subtracted from the crude production input. Vegetable oil production and refining are the two major energy consumption steps for biodiesel production consuming 48 and 49% of the fossil fuel, respectively. The major energy consumption step for petroleum diesel is refining (60% of total energy) followed by production (29% of total energy). The ethanol refining step (68%) is the major energy consumption step for ethanol production. From this life cycle analysis, it can be seen that future work on biodiesel production should focus first on developing high-yield crops that have small amounts of energy inputs and improving the refining process efficiencies.

Biodiesel standards have been developed for a number of countries and are reported elsewhere.³³ Table 28 lists fuel properties of various biodiesel fuels. All of these esters have high cetane numbers and flash points. Kinematic viscosities are also in an acceptable range for diesel fuels. The cetane numbers of methyl and ethyl esters can be correlated with the chain length and degree of saturation.³²⁹ Problems with

Table 28. Fuel Properties of Esters of Oils and Fats^a

oil or fat	ester	cetane number	ΔH_{comb} (kJ/kg)	kin visc (40 °C; mm ² /s)	cloud pt (°C)	pour pt (°C)	flash pt (°C)
coconut	ethyl	67.4	38158	3.08	5	-3	190
corn	methyl	65	38480	4.52	-3.4	-3	111
cottonseed	methyl	51.2		6.8 (21 °C)		-4	110
olive	methyl	61	37287	4.70	-2	-3	>110
palm	ethyl	56.2	39070	4.50 (37.8 °C)	8	6	
rapeseed	methyl	48-56	8850-39780	4.53-4.96	-6 to -3	-9	166-169
rapeseed	ethyl	67.5	40663	6.02	1	-12	170
soybean	methyl	49.6-51.5	37388-40080	3.99-4.30	-2 to 3	-7 to 0	120
sunflower	methyl	54-58	38100-38472	4.39	0-1.5	-3 to 3	110
tallow	methyl	61.8	37531-39961	4.11-4.99	12-15.6	9-12.8	96-188
yellow grease	methyl	62.6	37144-39817	5.16			
used frying oil	methyl	59	37337	4.50	1	-3	>110
waste olive oil	methyl	58.7		5.29	-2	-6	

^a Adapted from Knothe et al.³⁰⁷

biodiesel include high price, increased NO_x exhaust emissions, oxidative stability when exposed to air, and cold flow properties. The cold flow properties of a fuel are defined by its cloud point, pour point, and cold filter plugging point.

Biodiesel is an oxygenated fuel and when blended with petroleum-based diesel it reduces CO, particulate, and total hydrocarbon emissions. According to Knothe, biodiesel fuels have the following advantages when compared to petrochemical fuels:³⁰⁷

- (1) Derivation from renewable domestic resources
- (2) Biodegradability
- (3) Reduction of most exhaust emissions (with the exception of nitrogen oxides)
- (4) Higher flash point, leading to safer handling and storage
- (5) Excellent lubricity, which is particularly important for low-sulfur petrodiesel fuels, which have greatly reduced lubricity. Adding bio-diesel at low levels (1-2%) restores lubricity.

The EU produces 90% of the biodiesel in the world with a production capacity of 2.4 million metric tons of biodiesel per year.³³⁰ The EU has set a target of 5.75% renewable transportation fuels by 2010, and if this target is to be achieved with biodiesel fuels then the estimated production in Europe is 7.9 billion gallons/year.³⁰⁸ Brazil and the U.S. are the world's major oilseed producing countries. The EU has chosen to focus on biodiesel production because of the superior fuel economy of diesel engines, the agricultural practices in Europe, and the fact that most cars run on diesel fuel in the EU.³⁰⁸

10.2 Pyrolysis and Zeolite Upgrading

Pyrolysis of vegetable oil can be used to produce a liquid fuel that contains linear and cyclic paraffins, olefins, aldehydes, ketones, and carboxylic acids. Pyrolysis products of vegetable oils were used as a fuel during the first and second World Wars.³³¹ A possible mechanism for thermal decomposition of soybean oil is shown in Figure 41.³³² The exact thermal decomposition mechanism is very complex, generating a wide range of structures. Usually these mechanism proceed through either a free-radical or carbonium ion mechanism. Homologous alkanes and alkenes series occurs from the generation of RCOO radicals from triglyceride cleavage and subsequent loss of CO₂.³³² The R radical, upon disproportionation and ethylene elimination, gives the odd-numbered carbon alkanes and alkenes. Unsaturation increases cleavage at the α and β positions relative to the unsaturation.

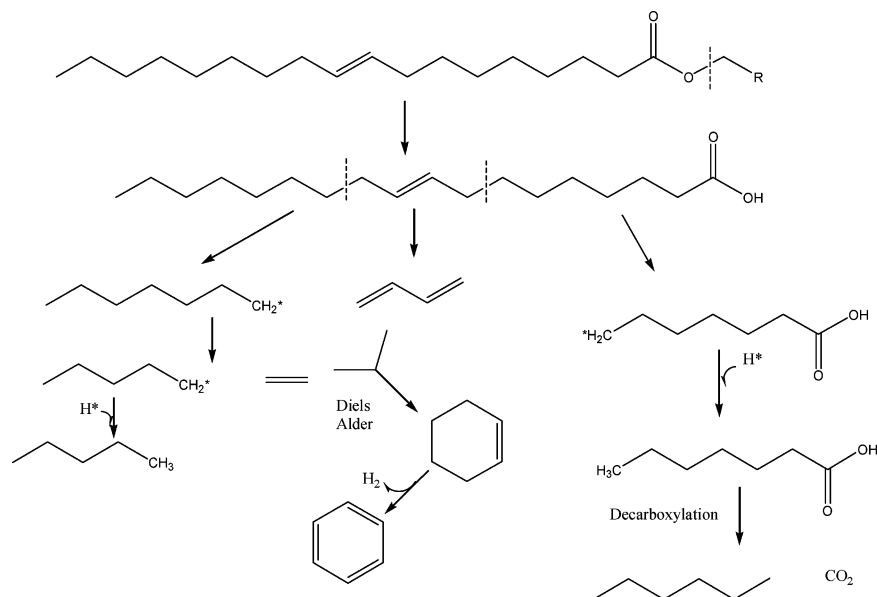

Figure 41. Mechanism for pyrolysis of triglycerides adapted from Schwab.³³²

Aromatics can form by a Diels–Alder reaction of ethylene to a conjugated diene. Hydrogen elimination occurs at high temperatures.

The pyrolysis reaction can be done with or without a catalyst, and a number of catalysts have been tested including HZSM-5, β -zeolite, and USY.^{333,334} Table 29 shows the molar

Table 29. Molar Selectivity as a Function of Temperature for Pyrolysis of Rapeseed^a

	selectivity (molar %)		
	600 °C	700 °C	800 °C
C ₁ –C ₄	18.6	38.7	45.1
C ₅ –C ₉	19.6	13.2	12.6
C ₁₀ –C ₁₄	3.5	2.7	1.0
C ₁₅ –C ₁₈	0.7	1.1	0.2
aromatics	2.0	3.9	11.6
C _{3:1} –C _{8:1} esters	16.6	7.2	4.1
C _{9:1} –C _{16:1} esters	3.2	2.3	0.5
saturated esters	1.2	2.4	3.1
CO	1.2	2.3	3.8
CO ₂	0.6	1.1	1.6
coke	3.8	4.7	3.1
other	29.0	20.4	13.3
H ₂	0.9	2.7	4.6

^a Adapted from Billaud et al.³³⁵

carbon selectivity for the pyrolysis reaction of rapeseed oil from 600 to 800 °C.³³⁵ As shown in Table 29, zeolite upgrading is a nonselective process making a range of compounds and undesired coke and lighter alkanes from vegetable oils. Zeolite catalysts also can produce aromatic compounds, and Twaiq et al. observed that upgrading of palm oil with ZSM-5 produced a yield of 28, 9, and 5% gasoline, kerosene, and diesel fuel, respectively.³³⁴ Lima et al. claim that pyrolysis products with a ZSM-5 catalyst and soybean and palm oil feedstock have fuel properties similar to Brazilian diesel fuel.³³¹ An advantage of the pyrolysis product is that no methanol or ethanol is required; however, the disadvantage is that the selectivity to liquid fuel products is not as high as with transesterification.

10.3. Hydrotreating

Vegetable oils can also be hydrotreated to produce straight chain alkanes ranging from C₁₂ to C₁₈.^{336–340} These alkanes

have high cetane numbers (55–65), and a 10-month on-road test of six postal delivery vans showed that engine fuel economy was greatly improved by a blend of petrodiesel with hydrotreated vegetable oil products.³⁴⁰ The reaction conditions for the hydrotreating process are 350–450 °C, 40–150 atm, liquid hourly space velocities 0.5–5.0 h⁻¹, and sulfided NiMo/Al₂O₃ catalysts.³³⁶ The alkanes can also be isomerized using molecular sieve or zeolite catalysts.³³⁷ According to Stumborg et al. the advantages of hydrotreating over esterification are that it has lower processing cost (50% that of esterification), compatibility with current infrastructure, engine compatibility, and feedstock flexibility.³³⁹ It would be desirable to develop nonsulfided hydrotreating catalysts, since vegetable oils do not have high sulfur contents. Alternatively, vegetable oils could be mixed with heavy gas-oil and hydrotreated in a petroleum refinery.

10.4. Microemulsions and Cosolvent Vegetable Oil Blends

Studies have been conducted on blending vegetable oil with petrodiesel, but these studies indicate that these blends are not suitable for long-term use in direct injection engines.³⁴¹ However, mixtures of vegetable oils with methanol or ethanol and an amphiphilic compound have been shown to be one way of producing a vegetable oil fuel blend that can be used in direct injection engines.³⁴¹ Amphiphilic compounds are added to increase the solubility of the alcohol. Alternatively, a cosolvent can be added to increase the solubility of vegetable oils with methanol or ethanol. Many variations of this approach have been used to make hybrid vegetable oil-diesel fuels.³⁴¹

10.5. Glycerol Utilization

Glycerol is currently too expensive to be used as a fuel; however, as biodiesel production increases the price of glycerol will decrease. Hydrogen can be produced from glycerol by aqueous-phase reforming^{25,160,271} (Section 8.3) or gas-phase steam reforming.³⁴² Another process for fuel production from glycerol is the etherification of glycerol with isobutylene and ion-exchange resin catalyst to produce butyl ethers of glycerol, which could be used as an oxygenated diesel fuel additive.^{343,344}

11.0. Ethical Considerations and Conclusions

11.1. Ethical Considerations

Biofuels should and can be produced sustainably with food and animal feed as coproducts.⁸ Ethical and moral questions arise when edible biomass products are converted into biofuels. Regions where malnutrition exists due to low levels of food production should first focus on producing edible biomass for food use before they produce biofuels from edible biomass. Shell Oil has a policy to only produce biofuels from nonedible fractions of biomass. However, as discussed in this review the largest fraction of biomass is nonedible lignocellulose such as straw, grasses, corn stover, wood, forest products, etc. Edible biomass is coproduced in plant material with lignocellulose biomass. Currently, the economics are more favorable for conversion of edible biomass into fuels due to their chemical structure, which can be more efficiently converted. Therefore, it is vital to continue to develop processes for conversion of lignocellulosic biomass into fuels. Agricultural practices in industrialized countries are very advanced, and most industrialized regions produce more than enough food for domestic food consumption. Farmers do not pick the crops based on how efficiently they produce edible food products. Instead farmers' goals are to grow crops that maximize their income, even though more efficient crops can be grown. Biofuels also can provide farmers in developing countries another market for their products, which could improve the economies of developing countries.

The EU has established as the main area of research second-generation biofuels from various biomass resources and wastes. As has been shown in this review, it is technically possible to convert cellulose materials and organic wastes into biofuels. However, costs have to be lowered and technology has to be demonstrated at a commercial scale (greater than 150 000 metric ton/year). If this is achieved, second-generation biofuels will secure a higher market share by allowing the use of a wider range of raw materials. Moreover, the cultivation process could be environmentally less intensive than for ordinary agricultural crops, with the corresponding cost decrease and lower greenhouse emission from cultivation. On these bases, the EU will support research on

- (a) Biomass to energy conversion processes
- (b) The "bio-refinery" concept to find valuable uses for all parts of the plant
- (c) Second-generation biofuels for improving efficiency and cost-effectiveness.

We recommend that sustainable policies be developed where food and animal feed is produced along with biofuels from our agricultural lands. Biofuels are only part of the answer to our dependence on fossil fuels. Other energy sources, such as wind, solar, hydroelectric, and nuclear power, should be used to produce electricity for stationary power production, and it is vital that we invest in other renewable sources along with biomass. More efficient energy conversion technologies for transportation vehicles, such as hybrid electric cars and fuel cells, should also continue to be developed. Finally, we need to strive to develop lifestyles that conserve energy.

11.2. Overall Conclusions

Regional issues greatly affect biomass cost, but biomass costs from cheapest to most expensive are typically ligno-

cellulose < starches < vegetable oils < terpenes < algae. Lignocellulose is the cheapest and most abundant form of biomass, and on an energy basis is significantly cheaper than crude oil. On agricultural land, the growth rate of lignocellulose on a per energy basis is 30–240 boe/ha-year. The limiting factor is that low-cost processing technologies that efficiently convert a large fraction of the lignocellulosic biomass energy into liquid fuels, do not yet exist.¹³ Vegetable oils, starches, and sugarcane currently have a lower cost of conversion into liquid fuels than lignocellulose feedstocks if feedstock costs are not considered. Terpenes and algae are currently too expensive to be used as liquid fuel feedstocks. Future work with lignocellulose feedstocks should focus on methods to convert lignocellulose into liquid fuels, whereas research on more expensive feedstocks, which are easier to break down into liquid fuels, such as vegetable oils and terpenes, should focus on development of better crops through plant breeding and genetic engineering. Algae have a tremendous potential as a feedstock because they have very high growth rates and can be grown on nonagricultural land. However, algae are currently too expensive to be grown on energy farms, and future work should focus on the development of cheaper algae crops.

Figure 42 shows the different routes for production of liquid fuels from biomass discussed in this review. Table 30 summarizes the development stage, products, and challenges of each of these technologies. Some of the technologies are currently used commercially, some have been tested at the pilot scale, and others have been tested only at the laboratory scale. Lignocellulose materials consist of sugar polymers (cellulose and hemicellulose) and lignin, and lignocellulose into liquid fuels involves removal of oxygen as either CO₂ or H₂O. In this process, functionality is removed from a nonthermally stable molecule. This is the opposite of petroleum-type reactions that involve adding functionality to a highly thermally stable molecule with low functionality. The three basic technologies for lignocellulosic conversion into liquid fuels, (Figure 42) include gasification of lignocellulose to syn-gas followed by syn-gas conversion, production of bio-oils by pyrolysis or liquefaction followed by upgrading of bio-oils, and acid hydrolysis of biomass to monomer units, which can then be converted into fuels.

Gasification of biomass to syn-gas and its subsequent conversion into liquid fuels is a well established but expensive pathway that could rapidly become commercially practiced. The most established processes for biomass-derived syn-gas are production of H₂ (by the WGS reaction), methanol (by methanol synthesis), and liquid alkanes (by FTS). Methanol can be converted into gasoline, olefins, or H₂. During biomass gasification 23% of the energy of the biomass feedstock is lost.¹⁸⁰ Further conversion of the syn-gas to liquid fuels (FTS alkanes, methanol, or ethanol) is predicted to have an overall PTE between 0.2 and 0.4 (Table 9); thus, a large fraction of the biomass energy is lost in syn-gas conversion.¹¹⁴ It is likely that further advances in syn-gas conversion will only show modest improvements in increasing the PTE, since these processes have been studied for several decades. Production of liquid fuels from biomass by the gasification route is not currently economical competitive with production of liquid fuels from petroleum; however, researchers have predicted that in most EU countries syn-gas-derived biofuels can be cost competitive with petroleum-derived fuels if they are given tax exemptions.^{114,178,179}

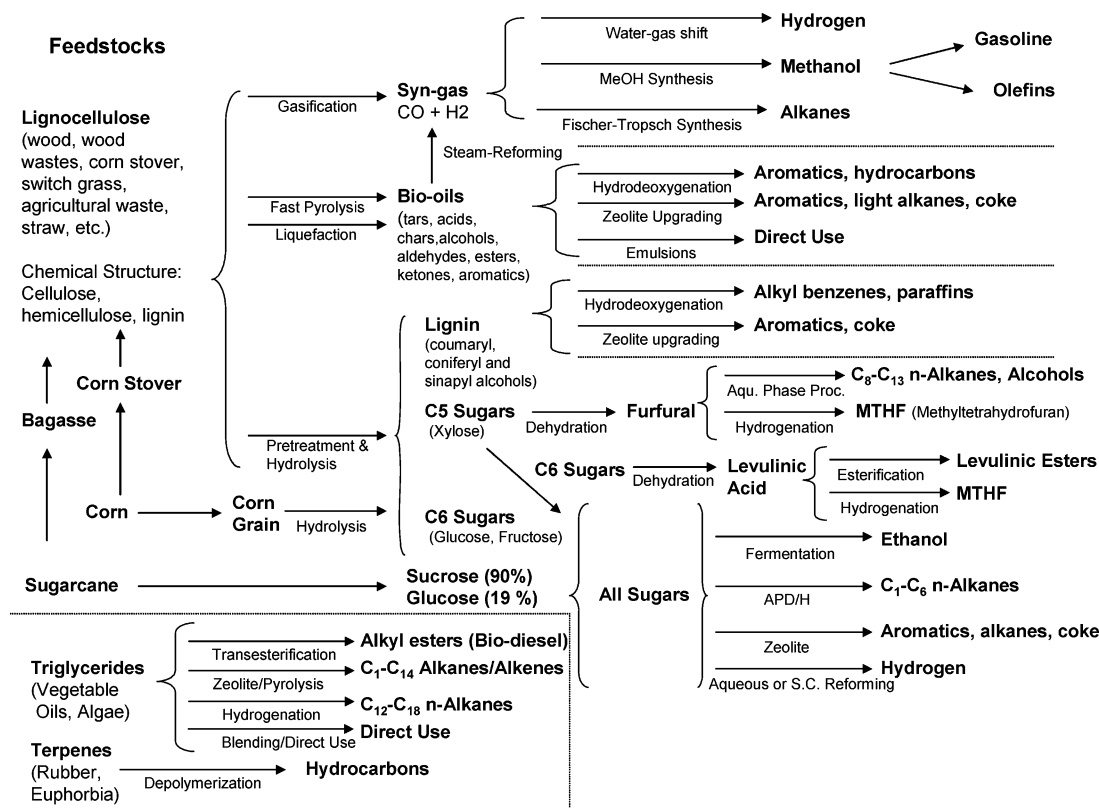

Figure 42. Known routes for production of liquid fuels from biomass.

Production of bio-oils by fast pyrolysis is a commercial technology; however, bio-oils are currently not being used for liquid fuels production. (Bio-oils instead are used for primarily for chemical production.) Bio-oils can be produced by high-pressure liquefaction; however, fast-pyrolysis is a cheaper technology.^{208,223} The PTE for bio-oil production by fast pyrolysis ranges from 61 to 68%.^{208,223} Bio-oils degrade with time and therefore cannot be used directly as a transportation fuel without upgrading or blending. Bio-oils can be upgraded by hydrodeoxygenation^{182,209} to produce hydrocarbons and aromatics, or zeolite upgrading (catalytic cracking),^{223,224,227–229} to produce aromatics light alkanes and coke. It has been predicted that both zeolite upgrading and hydrodeoxygenation of bio-oils decreases the energy content of the bio-oil to about 50% of the biomass feedstock,²²³ which is significantly higher than the overall thermal efficiency of biofuels derived from syn-gas. However, fuels derived from bio-oils have not been extensively tested, and the process of bio-oils upgrading must be further developed.

The third way for producing biofuels from lignocellulose involves the selective conversion of lignocellulose into sugar and lignin monomer units followed by their subsequent selective conversion into targeted products. It has been estimated that sugars can be produced from lignocellulose at costs of 5–14¢/kg.^{13,171} Efficient pretreatment methods are needed to facilitate conversion of biomass into monomer units.²⁵⁰ Sugars can be used to produce ethanol (by fermentation),³⁴⁵ alkanes (by aqueous-phase dehydration–hydrogenation),^{18,22,115} aromatics (by zeolite upgrading),²⁷⁰ or H₂ (by steam, supercritical or aqueous-phase reforming).^{69,81,160,238,271} The C₅ sugars can be dehydrated to furfural,²⁸⁰ which can be used as a feedstock for *n*-C₈–C₁₃ alkane production (by aqueous-phase processing)^{18,22} or MTHF (methyltetrahydrofuran) production (by hydrogenation).³⁰⁶ Glucose and other C₆ sugars can be used for levulinic acid production,^{260–262}

which can then be used to produce levulinic esters (by esterification)^{20,296} or MTHF (by hydrogenation).²⁹⁴ A recent process has been developed and tested at the commercial level to produce levulinic acid from biomass waste at an estimated cost of \$0.09–0.11/kg. MTHF is approved in the U.S. as an oxygenated gasoline additive. Levulinic esters can be used as an oxygenated diesel fuel additive.

Ethanol is the most widely used biofuel. Corn grain and sugarcane are the feedstocks used in Brazil and the U.S., respectively. Only the corn grain is used for sugar production, which contains starches that are easily converted into sugar monomers. The lignocellulose fraction of corn, corn stover, is currently not used for ethanol production; however, processes are being developed to utilize corn stover as a feedstock. Only the water-soluble sugars in sugarcane are used for ethanol production, and the bagasse (the lignocellulose section of sugarcane) is used to provide process heat. The overall PTE for production of ethanol is around 0.20–0.40³⁴⁵ and 0.29¹⁷⁷ for canesugar and corn grain feedstocks, respectively. The PTE for lignocellulose feedstocks is projected to be 49%, which is significantly higher than the PTE for sugar production from sugarcane and corn grain.¹⁷¹ A large fraction of the energy for ethanol production is for distillation to recover ethanol from the water.

Alkanes, which can be blended with gasoline or diesel fuel, produced by aqueous-phase dehydration/hydration (APD/H) of sugars, contain 95% of the energy of the sugar and only 30% of its mass.^{18,22} The advantage of alkane production by APD/H is that the majority of alkanes spontaneously separate from the aqueous-biomass feedstock; therefore, a significantly less energy is required for separation of alkanes from water than ethanol from water. While APD/H appears to be a promising technology for sugar conversion, it is only in the initial stage of development and will require more study before it can become a commercial process.

Table 30. Stages of Development for Production of Liquid Fuels from Biomass

technology	products	development stage	challenges
FTS of biomass-derived syn-gas	liquid alkanes	large scale pilot plant	controlling selectivity during FTS process, Tar removal/conversion from syn-gas
fermentation of biomass-derived syn-gas	ethanol	laboratory scale	development of enzyme catalysts
fast pyrolysis	bio-oils	commercial	bio-oils are unstable
liquefaction	bio-oils	pilot plant	bio-oils are unstable
hydrotreating of bio-oils	mixture of aromatics, alkanes	laboratory scale	bio-oils are unstable at high temperatures producing coke, requires expensive H ₂
zeolite upgrading (catalytic cracking) of bio-oils	mixture of aromatics, alkanes	laboratory scale	large amounts of coke produced, quality of final product low
fermentation of corn starch or sugarcane	ethanol	commercial	requires large amounts of energy for distillation
ethanol via fermentation of cellulosic biomass	ethanol	large scale pilot plant	conversion of cellulosic biomass to sugars, fermentation of C ₅ sugars, long residence times
hydrogenation of furfural (hemicellulose-derived)	methyl-tetrahydrofurfural	commercial for chemicals	not currently economical for fuels, need more efficient catalysts
aqueous-phase processing of sugar-derived feedstocks	straight chain alkanes (C ₁ –C ₁₆)	laboratory scale	need to test with real biomass feedstocks, need more efficient catalysts, multiple steps
esterification of levulinic acid	levulinic esters	laboratory scale	requires low-cost levulinic acid feedstock
hydrotreating of lignin	alkyl benzenes, paraffins	laboratory scale	conversion of solid lignin residue into a liquid; requires expensive H ₂
catalytic cracking of lignin	aromatics, coke	laboratory scale	large amounts of coke are produced
catalytic cracking of sugars	aromatics, coke	laboratory scale	large amounts of coke are produced
transesterification of vegetable oils	alkyl esters (bio-diesel)	commercial	high-cost of vegetable oils; need to replace mineral base catalysts.
hydrotreating of vegetable oils	alkanes (<i>n</i> -C ₁₂ –C ₁₈)	pilot plant	requires expensive H ₂
catalytic cracking of vegetable oils	aromatics, olefins, paraffins	laboratory scale	large amounts of coke are produced; multiple products produced

A large fraction of biomass is lignin, and in an ideal biorefinery the lignin should be used for biofuels and biochemicals production. Processes exist to convert lignin into liquid fuels including the production of alkyl benzenes and paraffins (by hydrodeoxygenation)^{285–288} or aromatics and coke (by zeolite upgrading).²⁸⁹ The alkyl benzenes and paraffins produced by hydrodeoxygenation can be used as a high-octane-oxygenated gasoline additive.^{290,291} The NREL has designed a process for lignin conversion based on hydrodeoxygenation and hydrocracking technology.^{290,291}

Triglycerides are high energy content molecules produced from biomass, and in Europe triglycerides derived from vegetable oils are the most widely used biomass feedstock. While triglycerides are more expensive than lignocellulosic biomass, they can efficiently be converted into liquid fuels. The liquid fuels include alkyl esters (or biodiesel by transesterification),³⁰⁷ C₁–C₁₄ alkanes/alkenes (by zeolite upgrading or pyrolysis),^{331–334} C₁₂–C₁₈ *n*-alkanes (by hydroprocessing) or be used directly. The direct use of vegetable oil causes engine problems; therefore, vegetable oils need to be converted prior to combustion.³⁰⁷ Biodiesel is produced by transesterification of vegetable oils. Glycerol is a byproduct of the transesterification process, and the sale of glycerol improves the economics of biodiesel production.^{35,308} However, it has been predicted that with increased biodiesel production the cost of glycerol will significantly decrease. Triglycerides can also be obtained from aquatic algae; however, current methods of algae production are too costly to use algae as a feedstock.³⁸

Biomass also produces hydrocarbons of molecular formula (C₅H₈)_{*n*} called terpenes. These natural hydrocarbons can be used as transportation fuels if they can be economically produced. Natural rubber, *cis*-1,4-polyisoprene, with a molecular weight from 500 000 to 2 000 000, is one example of terpenes. Natural rubber is produced commercially from the latex of the *Hevea brasiliensis* tree, a member of the Euphorbiaceae family.⁴⁰ The major problem with using terpenes as biofuel feedstocks is the high-cost of terpene production; therefore, research in this area should focus on developing a cheaper terpene feedstock.

Fuels are a low value commodity produced on a very large scale, and therefore development of economical processes for fuel production requires a large investment in both money and time. Most biomass conversion processes are started with the goal of rapidly developing commercial technologies. The fundamental chemistry of most of these reactions is not well understood, and it is likely that further scientific understanding will lead us to improved processes. It is vital that new more efficient catalysts be discovered for these reactions. It is likely that heterogeneous catalysis, which has been the backbone of the chemical and petroleum industry, will play a key role in the upcoming transition to the carbohydrate economy. According to Bridgwater, "The use of catalysts to improve either the yield or quality of gas and liquid fuels from thermochemical biomass conversion processes is still in its infancy. While there is extensive fundamental work underway, considerably more research is necessary to explore the wide range of conventional and unconventional catalysts."

Of particular potential significance is the integration of catalytic processes into the thermal conversion process to improve efficiency and reduce costs.²²³ Biological catalysts also appear to be promising; however, they are currently only used for ethanol production.

Importantly, we should not limit ourselves to current methods of production of liquid fuels but also should look to newer technologies and chemistry. In the short-term, this will require more development work, but in the long term it could yield significantly more energy. However, this will require a fundamental understanding of the chemistry and development of novel heterogeneous, homogeneous, and enzymatic catalysts. We believe that efficient processes for the sustainable production of biofuels will continue to be developed as the price of crude oil increases.

12. References

- Klass, D. L. In *Encyclopedia of Energy*; Cleveland, C. J., Ed.; Elsevier: London, 2004; Vol. 1.
- Klass, D. L. *Biomass for Renewable Energy, Fuels and Chemicals*; Academic Press: San Diego, 1998.
- Wyman, C. E.; Decker, S. R.; Himmel, M. E.; Brady, J. W.; Skopec, C. E.; Viikari, L. In *Polysaccharides*, 2nd ed.; Dumitriu, S., Ed.; Marcel Dekker: New York, 2005.
- Wyman, C. E.; Hinman, N. D. *Appl. Biochem. Biotechnol.* **1990**, *24/25*, 735.
- Wyman, C. E. *Appl. Biochem. Biotechnol.* **1994**, *45/46*, 897.
- Tyson, K. S. *Fuel Cycle Evaluations of Biomass-Ethanol and Reformulated Gasoline*; Report No. NREL/TP-263-2950, DE94000227, National Renewable Energy Laboratory: Golden, CO, 1993.
- Lynd, L. R.; Cushman, J. H.; Nichols, R. J.; Wyman, C. E. *Science* **1991**, *251*, 1318.
- Perlack, R. D.; Wright, L. L.; Turhollow, A.; Graham, R. L.; Stokes, B.; Erbach, D. C. Biomass as Feedstock for a Bioenergy and Bioproducts Industry: The Technical Feasibility of a Billion-Ton Annual Supply, Report No. DOE/GO-102995-2135; Oak Ridge National Laboratory: Oak Ridge, TN, 2005; <http://www.osti.gov/bridge>.
- Energy Information Administration Annual Energy Outlook 2005*; Report No. DOE/EIA-0383; U.S. Department of Energy: Washington, DC, 2006; <http://www.eia.doe.gov>.
- European Biomass Industry Association; <http://www.eubia.org>, accessed December 2005.
- Biofuels for Transport: An International Perspective*; International Energy Agency: Paris, France, 2004.
- Ugarte, D. G. D. L. T.; Walsh, M. E.; Shapouri, H.; Slinsky, S. P. *The Economic Impacts of Bioenergy Crop Production on U. S. Agriculture*; Agricultural Economic Report No. 816; U. S. Department of Agriculture: Washington, DC, 2003.
- Lynd, L. R.; Wyman, C. E.; Gerngross, T. U. *Biotechnol. Prog.* **1999**, *15*, 777.
- Energy Information Administration Official Energy Statistics*; U. S. Department of Energy, Washington, DC, 2006; http://tonto.eia.doe.gov/dnav/pet/pet_sum_top.asp.
- Biomass Research and Development Technical Advisory Committee Roadmap for Biomass Technologies in the U.S.*; U. S. Government, 2002; <http://www1.eere.energy.gov/biomass/publications.html>.
- Goudriaan, F.; Beld, B. v. d.; Boerefijn, F. R.; Bos, G. M.; Naber, J. E.; Wal, S. v. d.; Zeevalkink, J. A. *Progress in Thermochemical Biomass Conversion*; Tyrol, Austria, 2000.
- Homgren, J. American Chemical Society Annual Meeting, Atlanta, GA, 2006.
- Huber, G. W.; Chheda, J. N.; Barrett, C. J.; Dumesic, J. A. *Science* **2005**, *300*, 2075.
- Manzer, L. E. *Biomass Derivatives: A Sustainable Source of Chemicals*; National Science Foundation Workshop: Catalysis for Renewables Conversion, Arlington, VA, April 14–15, 2004; National Science Foundation: Washington, DC, 2004.
- Manzer, L. E. US 2005/0210738 A1, DuPont, 2005.
- Bendz, K. *EU-25 Oilseeds and Products Biofuels Situation in the European Union 2005*; GAIN Report No. E35058; USDA Foreign Agricultural Service: Washington, DC, 2005.
- Huber, G. W.; Dumesic, J. A. *Catal. Today* **2006**, *111*, 119.
- Owen, K.; Coley, T. *Automotive Fuels Handbook*; Society of Automotive Engineers: Warrendale, PA, 1990.
- Challen, B.; Baranescu, R. *Diesel Engine Reference Book*; Society of Automotive Engineers, Warrendale, PA, 1999.
- Cortright, R. D.; Davda, R. R.; Dumesic, J. A. *Nature* **2002**, *418*, 964.
- Towler, G. P.; Oroskar, A. R.; Smith, S. E. *Environ. Prog.* **2004**, *23*, 334.
- U.S. Department of Energy, *Feedstock Composition Gallery*, U.S. Department of Energy, Washington, DC, 2005; http://www.eere.energy.gov/biomass/feedstock_glossary.html.
- O'Sullivan, A. C. *Cellulose* **1997**, *4*, 173.
- Hsu, T. A.; Ladisch, M. R.; Tsao, G. T. *Chem. Technol.* **1980**, *10*, 315.
- Evans, R. J.; Milne, T. A.; Soltys, M. N. *J. Anal. Appl. Pyrolysis* **1986**, *9*, 207.
- Adler, E. *Wood Sci. Technol.* **1977**, *11*, 169.
- Chakar, F. S.; Ragauskas, A. J. *Ind. Crop. Prod.* **2004**, *20*, 131.
- Peterson, C. L. In *The Biodiesel Handbook*; Knothe, G., Krahl, J., Gerpen, J. V., Eds.; AOCS Press: Champaign, IL, 2005.
- Ma, F.; Hanna, M. A. *Bioresour. Technol.* **1999**, *70*, 1.
- Haas, M. J.; Foglia, T. A. In *The Biodiesel Handbook*; Knothe, G., Krahl, J., Gerpen, J. V., Eds.; AOCS Press: Champaign, IL, 2004.
- Erickson, D. R.; Pryde, E. H.; Brekke, O. L.; Mounts, T. L.; Falb, R. A. *Handbook of Soy Oil Processing and Utilization*; American Soybean Association and the American Oil Chemist's Society: St. Louis, Missouri and Champaign, IL, 1980.
- Wiltsee, G. *Urban Waste Grease Resource Assessment*; Report No. NREL/SR-570-26141; National Renewable Energy Laboratory: Golden, CO, 1998; <http://www.osti.gov/bridge>.
- Sheehan, J.; Dunahay, T.; Benemann, J.; Roessler, P. A Look Back at the U.S. Department of Energy's Aquatic Species Program-Biodiesel from Algae; Report No. NREL/TP-580-24190; National Renewable Energy Laboratory: Golden, CO, 1998; <http://www.osti.gov/bridge>.
- Hill, A. M.; Feinberg, D. A. *Fuel Products from Microalgae*; Report No. SERI/TP-231-2348; National Renewable Energy Laboratory: Golden, CO, 1984.
- Baker, C. S. L.; Fulton, W. S. In *Kirk-Othmer Encyclopedia of Chemical Technology*, 4th ed.; Kroschwitz, J. I., Howe-Grant, M., Eds.; John Wiley & Sons: New York, 1998; Vol. 21.
- Swift, K. A. D. *Top. Catal.* **2004**, *27*, 143.
- Buchanan, R. A.; Cull, I. M.; Otey, F. H.; Russell, C. R. *Econ. Bot.* **1978**, *32*, 146.
- Buchanan, R. A.; Cull, I. M.; Otey, F. H.; Russell, C. R. *Econ. Bot.* **1978**, *32*, 131.
- Calvin, M. J. *Appl. Biochem.* **1984**, *6*, 3.
- Calvin, M. *Energy* **1979**, *4*, 851.
- Beenackers, A. A. C. M.; Swaij, W. P. M. v. In *Thermochemical Processing of Biomass*; Bridgwater, A. V., Ed.; Butterworth: London, U.K., 1984.
- Bauen, A. In *Encyclopedia of Energy*; Cleveland, C. J., Ed.; Elsevier: Amsterdam, 2004; Vol. 1.
- Hos, J. J.; Groeneveld, M. J. In *Biomass*; Hall, D. O., Overend, R. P., Eds.; Wiley and Sons: Chichester, U.K., 1987.
- Babu, S. P. Observations on the current status of biomass gasification, manuscript in preparation.
- Milne, T. A.; Evans, R. J.; Abatzoglou, N. *Biomass Gasifier Tars: Their Nature, Formation and Conversion*; Report No. NREL/TP-570-25357; National Renewable Energy Laboratory: Golden, CO, 1998; <http://www.osti.gov/bridge>.
- Rostrup-Nielsen, J. R. *Catal. Today* **2002**, *71*, 243.
- Rostrup-Nielsen, J. R. *Catal. Rev. - Sci. Eng.* **2004**, *46*, 247.
- Evans, R. J.; Milne, T. A. *Energy Fuels* **1987**, *1*, 123.
- Narváez, I.; Prio, A.; Aznar, M. P.; Corella, J. *Ind. Eng. Chem. Res.* **1996**, *35*, 2110.
- Devi, L.; Ptasiński, K. J.; Janssen, F. J. J. G. *Biomass Bioenergy* **2003**, *24*, 125.
- Dayton, D. A. *Review of the Literature on Catalytic Biomass Tar Destruction*; Report No. NREL/TP-510-32815; National Renewable Energy Laboratory: Golden, CO, 2002; <http://www.osti.gov/bridge>.
- Elliott, D. C. ACS Symposium Series 376, Denver, CO, 1987; p 55.
- Rapagná, S.; Jand, N.; Kiennemann, A.; Foscolo, P. U. *Biomass Bioenergy* **2000**, *19*, 187.
- Tomishige, K.; Asadullah, M.; Kunimori, K. *Catal. Today* **2004**, *89*, 389.
- Baker, E. G.; Mudge, L. K.; Brown, M. D. *Ind. Eng. Chem. Res.* **1987**, *26*, 1335.
- Sutton, D.; Kelleher, B.; Ross, J. R. H. *Fuel Process. Technol.* **2001**, *73*, 155.
- Mudge, L. K.; Baker, E. G.; Mitchell, D. H.; Brown, M. D. *J. Solar Energy Eng.* **1985**, *107*, 89.
- Hallen, R. T.; Sealock, L. T.; Cuello, R.; Bridgwater, A. V. In *Research in Thermochemical Biomass Conversion*; Kuester, J. L., Ed.; Elsevier: London, UK, 1988.

- (64) Encinar, J. M.; Beltran, F. J.; Ramiro, A.; Gonzalez, J. F. *Fuel Process. Technol.* **1998**, *55*, 219.
- (65) Antal, M. J.; Varhegyi, G. *Ind. Eng. Chem. Res.* **1995**, *34*, 703.
- (66) Raveendran, K.; Ganesh, A.; Khilar, K. C. *Fuel* **1995**, *74*, 631.
- (67) Raveendran, K.; Ganesh, A.; Khilar, K. C. *Fuel* **1996**, *75*, 987.
- (68) Richeard, G. N.; Zheng, G. *J. Anal. Appl. Pyrolysis* **1991**, *21*, 133.
- (69) Matsumura, Y.; Minowa, T.; Potic, B.; Kersten, S. R. A.; Prins, W.; Swaaij, W. P. M. v.; Beld, B. v. d.; Elliott, D. C.; Neuenschwander, G. G.; Kruse, A.; Antal, M. J. *Biomass Bioenergy* **2005**, *29*, 269.
- (70) Modell, M. *Am. Soc. Mech. Eng.*, 1977.
- (71) Modell, M.; Reid, R. C.; Amin, S. I. US Patent 4,113, 446; Massachusetts Institute of Technology, 1978.
- (72) Lee, I. G.; Lee, J. S.; Kim, M. S. Proceedings of The 5th Korea-Japan Joint Symposium '99 on Hydrogen Energy, The Korea Energy Society: Yusong, Taejon, Korea, 1999; p 365.
- (73) Antal, M. J.; Allen, S. G.; Schulman, D.; Xu, X. D.; Divilio, R. J. *Ind. Eng. Chem. Res.* **2000**, *39*, 4040.
- (74) Yu, D.; Aihara, M.; Antal, M. J. *Energy Fuels* **1993**, *7*, 574.
- (75) Elliott, D. C.; Sealock, J. L. In *Fundamentals of Thermochemical Biomass Conversion*; Overend, R. P., Milne, T. A., Mudge, L. K., Eds.; Elsevier: London, UK, 1985.
- (76) Elliott, D. C.; L. J. Sealock, J.; Baker, E. G. *Ind. Eng. Chem. Res.* **1993**, *32*, 1542.
- (77) Xu, X.; Matsumura, Y.; Stenberg, J.; Antal, M. J. *Ind. Eng. Chem. Res.* **1996**, *35*, 2522.
- (78) Aznar, M. P.; Corella, J.; Delgado, J.; Lahoz, J. *Ind. Eng. Chem. Res.* **1993**, *32*, 1.
- (79) Rustamov, V. R.; Abdullayev, K. M.; Aliyev, F. G.; Kerimov, V. K. *Int. J. Hydr. Ener.* **1998**, *23*, 649.
- (80) Reed, T. *Problems and Opportunities for Solar Energy in Biomass, Pyrolysis, and Gasification*; Report No. SERI/TP-332-495; Solar Energy Research Institute: Golden, CO, 1979.
- (81) Antal, M. J. Synthesis gas production from organic wastes by pyrolysis/steam reforming, In *Energy from Biomass and Wastes* symposium; Symposium papers presented August 14–18, 1978, Washington, DC; Institute of Gas Technology, Chicago; p 495.
- (82) Antal, M. J.; Hofmann, L.; Moreira, J. R.; Brown, C. T.; Steenblik, R. *Solar Energy* **1983**, *30*, 299.
- (83) Antal, M. J.; Rodot, M.; Royere, C.; Vialaron, A. Proceedings of the International Solar Energy Society Silver Jubilee Congress, Atlanta, May 28–June 1, 1979; Böer, K. W., Glenn, B. H., Eds.; Pergamon, New York, 1979.
- (84) Adinberg, R.; Epstein, M.; Karni, J. *Trans. ASME* **2004**, *126*, 850.
- (85) Bain, R. L.; Dayton, D. C.; Carpenter, D. L.; Czernik, S. R.; Feik, C. J.; French, R. J.; Magrini-Bair, K. A.; Phillips, S. D. *Ind. Eng. Chem. Res.* **2005**, *44*, 7945.
- (86) Stevens, D. J. *Hot Gas Conditioning: Recent Progress With Larger-Scale Biomass Gasification Systems*; Report No. NREL/SR-510-29952; National Renewable Energy Laboratory, Golden, CO, 2001; <http://www.osti.gov/bridge>.
- (87) Delgado, J.; Aznar, M. P.; Corella, J. *Ind. Eng. Chem. Res.* **1997**, *36*, 1535.
- (88) Delgado, J.; Aznar, M. P.; Corella, J. *Ind. Eng. Chem. Res.* **1996**, *35*, 3637.
- (89) Simell, P. A.; Leppälähti, J. K.; Bredenberg, J. B. S. *Fuel* **1992**, *71*, 211.
- (90) Simell, P. A.; Leppälähti, J. K.; Kurkela, E. A. *Fuel* **1995**, *74*, 938.
- (91) Simell, P. A.; Hirvensalo, E. K.; Smolander, V. T.; Krause, A. O. I. *Ind. Eng. Chem. Res.* **1999**, *38*, 1250.
- (92) Narváez, I.; Corella, J.; Orío, A. *Ind. Eng. Chem. Res.* **1997**, *36*, 317.
- (93) Aznar, M. P.; Caballero, M. A.; Gil, J.; Martin, J. A.; Corella, J. *Ind. Eng. Chem. Res.* **1998**, *37*, 2668.
- (94) Devi, L.; Ptasinski, K. J.; Janssen, F. J. G. *Fuel Process. Technol.* **2005**, *86*, 707.
- (95) Devi, L.; Craje, M.; Thüne, P.; Ptasinski, K. J.; Janssen, F. J. G. *Appl. Catal. A* **2005**, *294*, 68.
- (96) Rostrup-Nielsen, J. R. *Steam Reforming Catalysts, An Investigation of Catalysts for Tubular Steam Reforming of Hydrocarbons*; Taknisk Forlag: Copenhagen, 1975.
- (97) Farrauto, R. J.; Bartholomew, C. *Introduction to Industrial Catalytic Processes*; Chapman & Hall, London, UK, 1997.
- (98) Wei, J.; Iglesia, E. *J. Catal.* **2004**, *224*, 370.
- (99) Corella, J.; Orío, A.; Toledo, J. M. *Energy Fuels* **1999**, *13*, 702.
- (100) Gebhard, S. C.; Wang, D.; Overend, R. P.; Paisley, M. A. *Biomass Bioenergy* **1994**, *7*, 307.
- (101) Kinoshita, Ç. M.; Wang, Y.; Zhou, J. *Ind. Eng. Chem. Res.* **1995**, *34*, 2949.
- (102) Coll, R.; Salvado, J.; Farriol, X.; Montané, D. *Fuel Process. Technol.* **2001**, *74*, 19.
- (103) Simell, P. A.; Hepola, J. O.; Krause, A. O. I. *Fuel* **1997**, *76*, 1117.
- (104) Caballero, M. A.; Corella, J.; Aznar, M. P.; Gil, J. *Ind. Eng. Chem. Res.* **2000**, *39*, 1143.
- (105) Hepola, J.; Simell, P. *Appl. Catal. B* **1997**, *14*, 287.
- (106) Hepola, J.; Simell, P. *Appl. Catal. B* **1997**, *14*, 305.
- (107) Depner, H.; Jess, A. *Fuel* **1999**, *78*, 1369.
- (108) Bangala, D. N.; Abatzoglou, N.; Chornet, E. *AIChE J.* **1998**, *44*, 927.
- (109) Wang, T. J.; Chang, J.; Wu, C. Z.; Fu, Y.; Chen, Y. *Biomass Bioenergy* **2005**, *28*, 508.
- (110) Furusawa, T.; Tsutsumi, A. *Appl. Catal. A* **2005**, *278*, 195.
- (111) Furusawa, T.; Tsutsumi, A. *Appl. Catal. A* **2005**, *278*, 207.
- (112) Rapagná, S.; Provendier, H.; Petit, C.; Kiennemann, A.; Foscolo, P. U. *Biomass Bioenergy* **2002**, *22*, 377.
- (113) Martínez, R.; Romero, E.; García, L.; Bilbao, R. *Fuel Process. Technol.* **2003**, *85*, 201.
- (114) Spath, P. L.; Dayton, D. C. *Preliminary Screening – Technical and Economic Assessment of Synthesis Gas to Fuels and Chemicals with Emphasis on the Potential for Biomass-Derived Syngas*; Report No. NREL/TP-510-34929; National Renewable Energy Laboratory, Golden, CO, 2003; <http://www.osti.gov/bridge>.
- (115) Huber, G. W.; Cortright, R. D.; Dumesic, J. A. *Angew. Chem., Int. Ed.* **2004**, *43*, 1549.
- (116) Rostrup-Nielsen, J. R. *Phys. Chem. Chem. Phys.* **2001**, *3*, 283.
- (117) Haruta, M.; Tsubota, S.; Kobayashi, T.; Kageyama, H.; Genet, M. J.; Delmon, B. *J. Catal.* **1993**, *144*, 175.
- (118) Guzman, J.; Carrettin, S.; Fierro-Gonzalez, J. C.; Hao, Y.; Gates, B. C.; Corma, A. *Angew. Chem., Int. Ed.* **2005**, *44*, 4778.
- (119) Fu, Q.; Deng, W.; Saltsburg, H.; Flytzani-Stephanopoulos, M. *Appl. Catal. B* **2005**, *56*, 57.
- (120) Fu, Q.; Saltsburg, H.; Flytzani-Stephanopoulos, M. *Science* **2003**, *301*, 935.
- (121) Carrettin, S.; Concepcion, P.; Corma, A.; Nieto, J. M. L.; Puentes, V. F. *Angew. Chem., Int. Ed.* **2004**, *43*, 2538.
- (122) Zhang, R.; Brown, R. C.; Suby, A. *Energy Fuels* **2004**, *18*, 251.
- (123) Zhang, R.; Cummer, K.; Suby, A.; Brown, R. C. *Fuel Process. Technol.* **2005**, *86*, 861.
- (124) Kim, W. B.; Voitl, T.; Rodriguez-Rivera, G. J.; Evans, S. T.; Dumesic, J. A. *Angew. Chem. Int. Ed.* **2005**, *44*, 778.
- (125) Kim, W. B.; Voitl, T.; Rodriguez-Rivera, G. J.; Dumesic, J. A. *Science* **2004**, *305*, 1280.
- (126) Kim, W. B.; Rodriguez-Rivera, G. J.; Evans, S. T.; Voitl, T.; Einspahr, J. J.; Voyles, P. M.; Dumesic, J. A. *J. Catal.* **2005**, *235*, 327.
- (127) Levin, D. B.; Pitt, L.; Love, M. *Int. J. Hydrogen Energy* **2004**, *29*, 173.
- (128) Chinchin, G. C.; Denny, P. J.; Jennings, J. R.; Spencer, M. S.; Waugh, K. C. *Appl. Catal.* **1988**, *36*, 1.
- (129) Liu, G.; Willcox, D.; Garland, M.; Kung, H. H. *J. Catal.* **1984**, *90*, 139.
- (130) Klier, K. *Adv. Catal.* **1982**, *31*, 243.
- (131) Greeley, J.; Gokhale, A. A.; Kreuser, J.; Dumesic, J. A.; Topsoe, H.; Topsoe, N. Y.; Mavrikakis, M. *J. Catal.* **2003**, *213*, 63.
- (132) Klier, K.; Chatikavanij, V.; Herman, R. G.; Simmons, G. W. *J. Catal.* **1982**, *74*, 343.
- (133) Muhler, M.; Tornqvist, E.; Nielsen, L. P.; Clausen, B. S.; Topsoe, H. *Catal. Lett.* **1994**, *25*, 1.
- (134) Dybkjaer, I.; Christensen, T. S. *Stud. Surf. Sci. Catal.* **2001**, *136 (Natural Gas Conversion VI)*, 435.
- (135) Wender, I. *Fuel Process. Technol.* **1996**, *48*, 189.
- (136) Reed, T. B.; Lerner, R. M. *Science* **1973**, *182*, 1299.
- (137) Klausmeier, R. F.; Billick, I. F. *Energy Fuels* **1993**, *7*, 27.
- (138) Specht, M.; Staiss, F.; Bandi, A.; Weimer, T. *Int. J. Hydrogen Energy* **1998**, *23*, 387.
- (139) Arico, A. S.; Srinivasan, S.; Antonucci, V. *Fuel Cells* **2001**, *1*, 133.
- (140) Dillon, R.; Srinivasan, S.; Arico, A. S.; Antonucci, V. *J. Power Sources* **2004**, *127*, 112.
- (141) Cubeiro, M. L.; Fierro, J. L. G. *J. Catal.* **1998**, *179*, 150.
- (142) Agrell, J.; Birgersson, H.; Boutonnet, M.; Melian-Cabrera, I.; Navarro, R. M.; Fierro, J. L. G. *J. Catal.* **2003**, *219*, 389.
- (143) Liu, S.; Takahashi, K.; Uematsu, K.; Ayabe, M. *Appl. Catal. A* **2005**, *283*, 125.
- (144) Park, G.-G.; Yim, S.-D.; Yoon, Y.-G.; Lee, W.-Y.; Kim, C.-S.; Seo, D.-J.; Eguchi, K. *J. Power Sources* **2005**, *145*, 702.
- (145) Iwasa, N.; Yoshikawa, M.; Nomura, W.; Arai, M. *Appl. Catal. A* **2005**, *292*, 215.
- (146) Brown, L. F. *Int. J. Hydrogen Energy* **2001**, *26*, 381.
- (147) Corma, A. *Studies in Surface Science and Catalysis*; Elsevier: Amsterdam, 1994; Vol. 83, p 461.
- (148) Collignon, F.; Loenders, R.; Martens, J. A.; Jacobs, P. A.; Poncelet, G. *J. Catal.* **1999**, *182*, 302.
- (149) Stöcker, M. *Microporous Mesoporous Mater.* **1999**, *29*, 3.
- (150) Keil, F. J. *Microporous Mesoporous Mater.* **1999**, *29*, 49.
- (151) Cambor, M. A.; Corma, A.; Lightfoot, P.; Villaescusa, L. A.; Wright, P. A. *Angew. Chem., Int. Ed. Engl.* **1997**, *36*, 2659.
- (152) Corma, A.; Rey, F.; Rius, J.; Sabater, M. J.; Valencia, S. *Nature* **2004**, *431*, 287.

- (153) Cantin, A.; Corma, A.; Leiva, S.; Rey, F.; Rius, J.; Valencia, S. *J. Am. Chem. Soc.* **2005**, *127*, 11560.
- (154) Peng, X. D.; Wang, A. W.; Toseland, B. A.; Tijm, P. J. A. *Ind. Eng. Chem. Res.* **1999**, *38*, 4381.
- (155) Ge, Q.; Huang, Y.; Qiu, F.; Li, S. *Appl. Catal. A* **1998**, *167*, 23.
- (156) Lee, S.; Saresai, A. *Top. Catal.* **2005**, *32*, 197.
- (157) Sardesai, A.; Lee, S. *Rev. Proc. Chem. Eng.* **1998**, *1*, 141.
- (158) Mills, G. A. *Fuel* **1994**, *73*, 1243.
- (159) Shabaker, J. W.; Davda, R. R.; Huber, G. W.; Cortright, R. D.; Dumesic, J. A. *J. Catal.* **2003**, *215*, 344.
- (160) Davda, R. R.; Shabaker, J. W.; Huber, G. W.; Cortright, R. D.; Dumesic, J. A. *Appl. Catal., B* **2005**, *56*, 171.
- (161) Dry, M. E. In *Catalysis Science and Technology*; Anderson, J. R., Boudart, M., Eds.; Springer-Verlag: New York, 1981.
- (162) Anderson, R. B. *The Fischer–Tropsch Synthesis*; Academic Press: Orlando, FL, 1984.
- (163) Dry, M. E. *Catal. Today* **2002**, *71*, 227.
- (164) Iglesia, E. *Appl. Catal. A* **1997**, *161*, 59.
- (165) Iglesia, E.; Reyes, S. C.; Madon, R. J.; Soled, S. L. *Adv. Catal.* **1993**, *39*, 221.
- (166) Bartholomew, C. H. *Stud. Surf. Sci. Catal.* **1991**, *64* (New Trends CO Act.), 158.
- (167) Martinez, A.; Lopez, C. *Appl. Catal. A* **2005**, *294*, 251.
- (168) Martinez, A.; Lopez, C.; Perid, E.; Corma, A. In *Stud. Surf. Sci. Catal.*; Cejka, J., Zilkova, N., Nachtigall, P., Eds.; Elsevier: Amsterdam, 2005; Vol. 158.
- (169) Boerrigter, H.; Uil, H. d.; Calis, H.-P. Pyrolysis and Gasification of Biomass and Waste Expert Meeting, September 30–October 1, 2002, Strasbourg, France, 2002.
- (170) Boerrigter, H. 'Green' Diesel Production with Fischer–Tropsch Synthesis; Report No. ECN-RX-03-014; Energy Research Centre of The Netherlands: Petten, 2003; http://www.ecn.nl/_files/bio/RX03014.pdf.
- (171) Aden, A.; Ruth, M.; Ibsen, K.; Jechura, J.; Neeves, K.; Sheehan, J.; Wallace, B.; Montague, L.; Slayton, A.; Lukas, J. *Lignocellulosic Biomass to Ethanol Process Design and Economics Utilizing Co-Current Dilute Acid Prehydrolysis and Enzymatic Hydrolysis for Corn Stover*; Report No. NREL/TP-510-32438; National Renewable Energy Laboratory: Golden, CO, 2002; <http://www.osti.gov/bridge>.
- (172) Klasson, K. T.; Ackerson, M. D.; Clausen, E. C.; Gaddy, J. L. *Fuel* **1993**, *73*, 1673.
- (173) Datar, R. P.; Shenkman, R. M.; Cateni, B. G.; Huhnke, R. L.; Lewis, R. S. *Biotechnol. Bioeng.* **2004**, *86*, 587.
- (174) Younesi, H.; Najafpour, G.; Mohamed, A. R. *Biochem. Eng. J.* **2005**, *27*, 110.
- (175) Phillips, J. R.; Clausen, E. C.; Gaddy, J. L. *Appl. Biochem. Biotechnol.* **1994**, *45–46*, 145.
- (176) Spath, P. L.; Mann, M. K.; Amos, W. A. *Update of Hydrogen from Biomass – Determination of the Delivered Cost of Hydrogen*; Report No. NREL/MP-510-33112; National Renewable Energy Laboratory: Golden, CO, 2003; <http://www.osti.gov/bridge>.
- (177) Shapouri, H.; Duffield, J. A.; Wang, M. *The Energy Balance of Corn: An Update*; Agricultural Economic Report 814; U. S. Department of Agriculture, Office of the Chief Economist, Washington, DC, 2002.
- (178) Hamelinck, C. N.; Faaij, A. P. C. *J. Power Sources* **2002**, *111*, 1.
- (179) Hamelinck, C. N.; Faaij, A. P. C.; Uil, H. d.; Boerrigter, H. *Energy* **2004**, *29*, 1743.
- (180) Prins, M. J.; Ptasinski, K. J.; Janssen, F. J. J. G. *Fuel Process. Technol.* **2004**, *86*, 375.
- (181) Stiegel, G. J.; Maxwell, R. C. *Fuel Process. Technol.* **2001**, *71*, 79.
- (182) Elliott, D. C.; Beckman, D.; Bridgwater, A. V.; Diebold, J. P.; Gevert, S. B.; Solantausta, Y. *Energy Fuels* **1991**, *5*, 399.
- (183) Bridgwater, A. V.; Peacocke, G. V. C. *Renewable Sustainable Energy Rev.* **2000**, *4*, 1.
- (184) Mohan, D.; Pittman, C. U.; Steele, P. H. *Energy Fuels* **2006**, *20*, 848.
- (185) Czernik, S.; Bridgwater, A. V. *Energy Fuels* **2004**, *18*, 590.
- (186) Brammer, J. G.; Bridgwater, A. V. *Renewable Sustainable Energy Rev.* **1999**, *3*, 243.
- (187) Scott, D. S.; Majerski, P.; Piskorz, J.; Radlein, D. *J. Anal. Appl. Pyrolysis* **1999**, *51*, 23.
- (188) Moffatt, J. M.; Overend, R. P. *Biomass* **1985**, *7*, 99.
- (189) Vanasse, C.; Chornet, E.; Overend, R. P. *Can. J. Chem. Eng.* **1988**, *66*, 112.
- (190) Diebold, J. P. A Review of the Chemical and Physical Mechanisms of the Storage Stability of Fast Pyrolysis Bio-Oils; Report No. NREL/SR-570-27613; National Renewable Energy Laboratory: Golden, CO, 2000; <http://www.osti.gov/bridge>.
- (191) Milne, T. A.; Agblevor, F.; Davis, M.; Deutch, S.; Johnson, D. In *Developments in Thermal Biomass Conversion*; Bridgwater, A. V., Boocock, D. G. B., Eds.; Blackie Academic and Professional: London, UK, 1997.
- (192) Branca, C.; Giudicianni, P.; Blasi, C. D. *Ind. Eng. Chem. Res.* **2003**, *42*, 3190.
- (193) Shafizadeh, F. *J. Anal. Appl. Pyrolysis* **1982**, *3*, 283.
- (194) Nimlos, M. R.; Blanksby, S. J.; Ellison, G. B.; Evans, R. J. *J. Anal. Appl. Pyrolysis* **2003**, *66*, 3.
- (195) Dobelev, G.; Rossinskaja, G.; Dizhbite, T.; Telysheva, G.; Meier, D.; Faix, O. *J. Anal. Appl. Pyrolysis* **2005**, *74*, 401.
- (196) Sanders, E. B.; Goldsmith, A. I.; Seeman, J. I. *J. Anal. Appl. Pyrolysis* **2003**, *66*, 29.
- (197) Antal, M. J.; Várhegyi, G.; Jakab, E. *Ind. Eng. Chem. Res.* **1998**, *37*, 1267.
- (198) Orfao, J. J. M.; Antunes, F. J. A.; Figueiredo, J. L. *Fuel* **1999**, *78*, 349.
- (199) Wooten, J. B.; Seeman, J. I.; Hajaligol, M. R. *Energy Fuels* **2004**, *18*, 1.
- (200) Brodov, A.; Nelson, M. A. *Combust. Flame* **1975**, *24*, 263.
- (201) Bradbury, A. G. W.; Sakai, Y.; Shafizadeh, F. *J. Appl. Polym. Sci.* **1979**, *23*, 3271.
- (202) Piskorz, J.; Radlein, D.; Scott, D. S.; Czernik, S. *J. Anal. Appl. Pyrolysis* **1989**, *16*, 127.
- (203) Diebold, J. P. *Biomass Bioenergy* **1994**, *7*, 75.
- (204) Kruse, A.; Gawlik, A. *Ind. Eng. Chem. Res.* **2003**, *42*, 267.
- (205) Kabyemela, B. M.; Adschiri, T.; Malaluan, R. M.; Arai, K. *Ind. Eng. Chem. Res.* **1999**, *38*, 2888.
- (206) Watanabe, M.; Aizawa, Y.; Iida, T.; Levy, C.; Aida, T. M.; Inomata, H. *Carbohydr. Res.* **2005**, *340*, 1931.
- (207) Antal, M. J.; Mok, W. S. L.; Richards, G. N. *Carbohydr. Res.* **1990**, *199*, 91.
- (208) Elliott, D. C.; Baker, E. G.; Beckman, D.; Solantausta, Y.; Tolenhimo, V.; Gevert, S. B.; Hörnell, C.; Östman, A.; Kjellström, B. *Biomass* **1990**, *22*, 251.
- (209) Furimsky, E. *Appl. Catal. A* **2000**, *199*, 147.
- (210) Sheu, Y.-H. E.; Anthony, R. G.; Soltes, E. J. *Fuel Process. Technol.* **1988**, *19*, 31.
- (211) Ramanathan, S.; Oyama, S. T. *J. Phy. Chem.* **1995**, *99*, 16365.
- (212) Elliott, D. C.; Neuenschwander, G. G. In *Developments in Thermo-Chemical Biomass Conversion*; Bridgwater, A. V., Boocock, D. G. B., Eds.; Blackie Academic and Professional: London, 1996; Vol. 1.
- (213) Elliott, D. C.; Baker, E. G.; Piskorz, J.; Scott, D. S.; Solantausta, Y. *Energy Fuels* **1988**, *2*, 234.
- (214) Elliott, D. C.; Oasmaa, A. *Energy Fuels* **1991**, *5*, 102.
- (215) Ferrari, M.; Maggi, R.; Delmon, B.; Grange, P. *J. Catal.* **2001**, *198*, 47.
- (216) Centeno, A.; Laurent, E.; Delmon, B. *J. Catal.* **1995**, *154*, 288.
- (217) Laurent, E.; Delmon, B. *Appl. Catal. A* **1994**, *109*, 77.
- (218) Laurent, E.; Delmon, B. *Appl. Catal. A* **1994**, *109*, 97.
- (219) Laurent, E.; Delmon, B. *J. Catal.* **1994**, *146*, 281.
- (220) Corma, A. *J. Catal.* **2003**, *216*, 298.
- (221) Corma, A. *Chem. Rev.* **1997**, *97*, 2373.
- (222) Corma, A. *Chem. Rev.* **1995**, *95*, 559.
- (223) Bridgwater, A. V. *Appl. Catal. A* **1994**, *116*, 5.
- (224) Adjaye, J. D.; Katikaneni, S. P. R.; Bakhshi, N. N. *Fuel Process. Technol.* **1996**, *48*, 115.
- (225) Sharma, R. K.; Bakhshi, N. N. *Energy Fuels* **1993**, *7*, 306.
- (226) Katikaneni, S. P. R.; Adjaye, J. D.; Bakhshi, N. N. *Energy Fuels* **1995**, *9*, 1065.
- (227) Srinivas, S. T.; Dalai, A. K.; Bakhshi, N. N. *Can. J. Chem. Eng.* **2000**, *78*, 343.
- (228) Gayubo, A. G.; Aguayo, A. T.; Atutxa, A.; Aguado, R.; Bilbao, J. *Ind. Eng. Chem. Res.* **2004**, *43*, 2610.
- (229) Gayubo, A. G.; Aguayo, A. T.; Atutxa, A.; Aguado, R.; Olazar, M.; Bilbao, J. *Ind. Eng. Chem. Res.* **2004**, *43*, 2619.
- (230) Gayubo, A. G.; Aguayo, A. T.; Atutxa, A.; Valle, B.; Bilbao, J. *J. Chem. Technol. Biotech.* **2005**, *80*, 1244.
- (231) Gallivan, R. M.; Mattschei, P. K. U.S. Patent 4233465, American Can Company, 1980.
- (232) Chum, H. L.; Black, S. K. U.S. Patent 4942269, Midwest Research Institute, 1990.
- (233) Ikura, M.; Stanculescu, M.; Hogan, E. *Biomass Bioenergy* **2003**, *24*, 221.
- (234) Chiaromonti, D.; Bonini, M.; Fratini, E.; Tondi, G.; Gartner, K.; Bridgwater, A. V.; Grimm, H. P.; Soldaini, I.; Webster, A.; Baglioni, P. *Biomass Bioenergy* **2003**, *25*, 85.
- (235) Chiaromonti, D.; Bonini, M.; Fratini, E.; Tondi, G.; Gartner, K.; Bridgwater, A. V.; Grimm, H. P.; Soldaini, I.; Webster, A.; Baglioni, P. *Biomass Bioenergy* **2003**, *25*, 101.
- (236) Wang, D.; Czernik, S.; Montane, D.; Mann, M.; Chornet, E. *Ind. Eng. Chem. Res.* **1997**, *36*, 1507.
- (237) Sanchez, J. L.; Gonzalo, A.; Gea, G.; Bilbao, R.; Arauzo, J. *Energy Fuels* **2005**, *19*, 2140.
- (238) Czernik, S.; French, R.; Feik, C.; Chornet, E. *Ind. Eng. Chem. Res.* **2002**, *41*, 4209.

- (239) Garcia, L.; French, R.; Czernik, S.; Chornet, E. *Appl. Catal. A* **2000**, *201*, 225.
- (240) Marquovich, M.; Czernik, S.; Chornet, E.; Montane, D. *Energy Fuels* **1999**, *13*, 1160.
- (241) Rioche, C.; Kulkarni, S.; Meunier, F. C.; Breen, J. P.; Burch, R. *Appl. Catal. B* **2005**, *61*, 130.
- (242) Takanabe, K.; Aika, K.-i.; Seshan, K.; Lefferts, L. *J. Catal.* **2004**, *227*, 101.
- (243) Panigrahi, S.; Dalai, A. K.; Chaudhari, S. T.; Bakhshi, N. N. *Energy Fuels* **2003**, *17*, 637.
- (244) Chaudhari, S. T.; Bej, S. K.; Bakhshi, N. N.; Dalai, A. K. *Energy Fuels* **2001**, *15*, 736.
- (245) Chaudhari, S. T.; Dalai, A. K.; Bakhshi, N. N. *Energy Fuels* **2003**, *17*, 1062.
- (246) Evans, R.; Czernik, S.; Chornet, E.; Feik, C.; Phillips, S. Proceedings of the 2001 DOE Hydrogen Program Review, U.S. Department of Energy, 2001.
- (247) Mosier, N.; Wyman, C.; Dale, B.; Elander, R.; Lee, Y. Y.; Holtzapple, M.; Ladisch, M. *Bioresour. Technol.* **2005**, *96*, 673.
- (248) Eggeman, T.; Elander, R. T. *Bioresour. Technol.* **2005**, *96*, 2019.
- (249) Wyman, C. E.; Dale, B. E.; Elander, R. T.; Holtzapple, M.; Ladisch, M. R.; Lee, Y. Y. *Bioresour. Technol.* **2005**, *96*, 2026.
- (250) Wyman, C. E.; Dale, B. E.; Elander, R. T.; Holtzapple, M.; Ladisch, M. R.; Lee, Y. Y. *Bioresour. Technol.* **2005**, *96*, 1959.
- (251) Liu, C.; Wyman, C. E. *Bioresour. Technol.* **2005**, *96*, 1978.
- (252) Saeman, J. F. *Ind. Eng. Chem.* **1945**, *37*, 42.
- (253) Fan, L. T.; Gharpuray, M. M.; Lee, Y. H. *Cellulose Hydrolysis*; Springer-Verlag: Berlin, 1987.
- (254) Mok, W. S. L.; Antal, M. J. *J. Ind. Eng. Chem. Res.* **1992**, *31*, 94.
- (255) Lynd, L. R.; Weimer, P. J.; Zyl, W. H. v.; Pretorius, I. S. *Microbiol. Mol. Biol. Rev.* **2002**, *66*, 506.
- (256) Mosier, N. S.; Hall, P.; Ladisch, C. M.; Ladisch, M. R. *Adv. Biochem. Eng. Biotechnol.* **1999**, *65*, 23.
- (257) Allen, S. G.; Schulman, D.; Lichwa, J.; Antal, M. J. J.; Laser, M.; Lynd, L. R. *Ind. Eng. Chem. Res.* **2001**, *40*, 2934.
- (258) Lloyd, T. A.; Wyman, C. E. *Bioresour. Technol.* **2005**, *96*, 1967.
- (259) Horvat, J.; Klaić, B.; Metelko, B.; Sunjic, V. *Tetrahedron Lett.* **1985**, *26*, 2111.
- (260) Fitzpatrick, S. W. U.S. Patent 4897497; Biofine Incorporated, 1990.
- (261) Fitzpatrick, S. W. U.S. Patent 5608105; Biofine Incorporated, 1997.
- (262) Fitzpatrick, S. W. *Final Technical Report Commercialization of the Biofine Technology for Levulinic Acid Production from Paper Sludge*; BioMetics, Inc.; Report No. DOE/CE/41178; U.S. Department of Energy: Washington, DC, 2002; <http://www.osti.gov/bridge>.
- (263) Robinson, J. M.; Burgess, C. E.; Bently, M. A.; Brasher, C. D.; Horne, B. O.; Lillard, D. M.; Macias, J. M.; Mandal, H. D.; Mills, S. C.; O'Hara, K. D.; Pon, J. T.; Raigoza, A. F.; Sanchez, E. H.; Villarreal, J. S. *Biomass Bioenergy* **2004**, *26*, 473.
- (264) Wyman, C. In *Encyclopedia of Energy*; Cleveland, C. J., Ed.; Elsevier: London, 2004; Vol. 2.
- (265) Aristidou, A.; Penttila, M. *Curr. Opin. Biotechnol.* **2000**, *11*, 187–198.
- (266) Sonderegger, M.; Jeppsson, M.; Larsson, C.; Gorwa-Grauslund, M.-F.; Boles, E.; Olsson, L.; Spencer-Martins, I.; Hahn-Hagerdal, B.; Sauer, U. *Biotechnol. Bioeng.* **2004**, *87*, 90.
- (267) Shapouri, H.; Gallagher, P.; Graboski, M. S. *USDA's 1998 Ethanol Cost-of Production Survey*; Agricultural Economic Report Number 808; U.S. Department of Agriculture, Office of the Chief Economist, Washington, DC, 1998.
- (268) Wooley, R.; Ruth, M.; Glassner, D.; Sheehan, J. *Biotechnol. Prog.* **1999**, *15*, 794.
- (269) Pimentel, D.; Patzek, T. W. *Nat. Res. Res.* **2005**, *14*, 65–76.
- (270) Chen, N. Y.; T. F. Degnan, J.; Koenig, L. R. *Chemtech* **1986**, *16*, 506.
- (271) Huber, G. W.; Shabaker, J. W.; Dumesic, J. A. *Science* **2003**, *300*, 2075.
- (272) Davda, R. R.; Shabaker, J. W.; Huber, G. W.; Cortright, R. D.; Dumesic, J. A. *Appl. Catal., B* **2003**, *43*, 1.
- (273) Shabaker, J. W.; Dumesic, J. A. *Ind. Eng. Chem. Res.* **2004**, *43*, 3105.
- (274) Davda, R. R.; Dumesic, J. A. *Angew. Chem., Int. Ed.* **2003**, *42*, 4068.
- (275) Shabaker, J. W.; Huber, G. W.; Dumesic, J. A. *J. Catal.* **2004**, *222*, 180.
- (276) Davda, R. R.; Dumesic, J. A. *Chem. Commun.* **2004**, 36.
- (277) Shabaker, J. W.; Huber, G. W.; Davda, R. R.; Cortright, R. D.; Dumesic, J. A. *Catal. Lett.* **2003**, *88*, 1.
- (278) Huber, G. W.; Shabaker, J. W.; Evans, S. T.; Dumesic, J. A. *Appl. Catal., B* **2006**, *62*, 226.
- (279) Shabaker, J. W.; Simonetti, D. A.; Cortright, R. D.; Dumesic, J. A. *J. Catal.* **2005**, *231*, 67.
- (280) Zeitsch, K. J. *The Chemistry and Technology of Furfural and its Many By-Products*; Elsevier: London, 2000.
- (281) Hallenbeck, P. C.; Benemann, J. R. *Int. J. Hydrogen Energy* **2002**, *27*, 1185.
- (282) Nath, K.; Das, D. *Appl. Microbiol. Biotechnol.* **2004**, *65*, 520.
- (283) Khanal, S. K.; Chen, W.-H.; Li, L.; Sung, S. *Int. J. Hydrogen Energy* **2004**, *29*, 1123.
- (284) Gosselink, R. J. A.; Jong, E. d.; Guran, B.; Abacherli, A. *Ind. Crop. Prod.* **2004**, *20*, 121.
- (285) Piskorz, J.; Majerski, P.; Radlein, D.; Scott, D. S. *Energy Fuels* **1989**, *3*, 723.
- (286) Train, P. M.; Klein, M. T. *Fuel Sci. Technol.* **1991**, *9*, 193.
- (287) Ratcliff, M. A.; Johnson, D. K.; Posey, F. L.; Chum, H. L. *Appl. Biochem. Biotechnol.* **1988**, *17*, 151.
- (288) Oasmaa, A.; Alen, R.; Meier, D. *Bioresour. Technol.* **1993**, *45*, 189.
- (289) Thring, R. W.; Katikaneni, S. P. R.; Bakhshi, N. N. *Fuel Process. Technol.* **2000**, *62*, 17.
- (290) Shabtai, J. S.; Zmierzczak, W. W.; Chornet, E. US Patent 5959167, The University of Utah Research Foundation, 1999.
- (291) Montague, L. *Lignin Process Design Confirmation and Capital Cost Evaluation*; Report No. NREL/SR-510-31579; National Renewable Energy Laboratory, Golden, CO, 2003; <http://www.osti.gov/bridge>.
- (292) Miller, J. E.; Evans, L.; Littlewolf, A.; Trudell, D. E. *Fuel* **1999**, *78*, 1363.
- (293) Shabtai, J. S.; Zmierzczak, W. W.; Chornet, E. U.S. Patent 6172272 B1, The University of Utah, 2001.
- (294) Elliott, D. C.; Frye, J. G. U.S. Patent 5883266, Battelle Memorial Institute, 1999.
- (295) Rae, A.; Hodgson, W. World Patent WO 03/002696 A1, AAE Technologies International PLC, 2003.
- (296) Manzer, L. E. U.S. 2005/0171374, DuPont, 2005.
- (297) Fagan, P. J.; Korovessi, E.; Manzer, L. E.; Mehta, R.; Thomas, S. M. International Patent Number WO 03/085071 A1, Dupont, 2003.
- (298) Montane, D.; Salvado, J.; Torras, C.; Farriol, X. *Biomass Bioenergy* **2002**, *22*, 295.
- (299) Kottke, R. H. *Kirk-Othmer Encyclopedia of Chemical Technology*, 4th ed.; Kroschwitz, J. I., Howe-Grant, M., Eds.; John Wiley & Sons: New York, 1998; Vol. Supplement.
- (300) Antal, M. J.; Leesomboon, T.; Mok, W. S.; Richards, G. N. *Carbohydr. Res.* **1991**, *217*, 71.
- (301) Zeitsch, K. J. International Patent WO 00/47569, 2000.
- (302) Dias, A. S.; Pillinger, M.; Valente, A. A. *J. Catal.* **2005**, *229*, 414.
- (303) Dias, A. S.; Pillinger, M.; Valente, A. A. *Appl. Catal. A* **2005**, *285*, 126.
- (304) Moreau, C.; Durand, R.; Peyron, D.; Duhamet, J.; Rivalier, P. *Ind. Crop. Prod.* **1998**, *7*, 95.
- (305) Bayan, S.; Beati, E. *Chim. Ind. (Milan, Italy)* **1941**, *23*, 432.
- (306) Ahmed, I. U.S. Patent Application, US 2005/0176974 A1, 2005.
- (307) Knothe, G.; Krahl, J.; Gerpen, J. V. *The Biodiesel Handbook*; AOCS Press: Champaign, Illinois, 2005.
- (308) Bray, R. G. *Biodiesel Production*; SRI Consulting, 2004.
- (309) Freedman, B.; Butterfield, R. O.; Pryde, E. H. *J. Am. Oil Chem. Soc.* **1986**, *63*, 1375.
- (310) Schuchardt, U.; Sercheli, R.; Vargas, R. M. *J. Braz. Chem. Soc.* **1998**, *9*, 199.
- (311) Nouredini, H.; Zhu, D. *J. Am. Oil Chem. Soc.* **1997**, *74*, 1457.
- (312) Gerpen, J. V.; Knothe, G. In *The Biodiesel Handbook*; Knothe, G., Krahl, J., Gerpen, J. V., Eds.; AOCS Press: Champaign, IL, 2005.
- (313) Lopez, D. E.; Jr., J. G. G.; Bruce, D. A.; Lotero, E. *Appl. Catal. A* **2005**, *295*, 97.
- (314) Toda, M.; Takagaki, A.; Okamura, M.; Kondo, J. N.; Hayashi, S.; Domen, K.; Hara, M. *Nature* **2005**, *438*, 178.
- (315) Kim, H.-J.; Kang, B.-S.; Kim, M.-J.; Park, Y. M.; Kim, D.-K.; Lee, J.-S.; Lee, K.-Y. *Catal. Today* **2004**, *93–95*, 315.
- (316) Cantrell, D. G.; Gillie, L. J.; Lee, A. F.; Wilson, K. *Appl. Catal. A* **2005**, *287*, 183.
- (317) Suppes, G. J.; Dasari, M. A.; Doskocil, E. J.; Mankidy, P. J.; Godd, M. J. *Appl. Catal. A* **2004**, *257*, 213.
- (318) Stern, R.; Hillion, G.; Rouxel, J.-J.; Leporq, S. U.S. Patent 5908946; Institut Francais de Petrole, 1999.
- (319) Corma, A.; Iborra, S.; Miquel, S.; Primo, J. *J. Catal.* **1998**, *173*, 315.
- (320) Corma, A.; Hamid, S. B. A.; Iborra, S.; Velty, A. *J. Catal.* **2005**, *234*, 340.
- (321) Climent, M. J.; Corma, A.; Iborra, S.; Epping, K.; Velty, A. *J. Catal.* **2004**, *225*, 316.
- (322) Warabi, Y.; Kusdiana, D.; Saka, S. *Bioresour. Technol.* **2003**, *91*, 283.
- (323) Demirbas, A. *Energy Convers. Manage.* **2002**, *43*, 2349.
- (324) Freedman, B.; Pryde, E. H.; Mounts, T. L. *J. Am. Oil Chem. Soc.* **1984**, *61*, 1638.
- (325) Mbaraka, I. K.; Shanks, B. H. *J. Catal.* **2005**, *229*, 365.
- (326) Haas, M. J.; McAloon, A. J.; Yee, W. C.; Foglia, T. A. *Bioresour. Technol.* **2006**, *97*, 671.
- (327) Schumacher, L. G.; Gerpen, J. V.; Adams, B. In *Encyclopedia of Energy*; Cleveland, C. J., Ed.; Elsevier: London, 2004.
- (328) Sheehan, J.; Camobreco, V.; Dumelfield, J.; Graboski, M.; Shapouri, H. An Overview of Biodiesel and Petroleum Diesel Life Cycles;

- Report No. NREL/TP-580-24772; National Renewable Energy Laboratory, Golden, CO, 1998; <http://www.osti.gov/bridge>.
- (329) Freedman, B.; Bagdy, M. O.; Callhan, T. J.; Ryan, T. W. *Cetane Numbers of Fatty Esters, Fatty Alcohols, and Triglycerides Determined in a Constant Volume Combustion Bomb*, Society of Automotive Engineers, Warrendale, Pennsylvania, 1990.
- (330) Bockey, D. In *The Biodiesel Handbook*; Knothe, G., Krahl, J., Gerpen, J. V., Eds.; AOCS Press: Champaign, IL, 2005.
- (331) Lima, D. G.; Soares, V. C. D.; Ribeiro, E. B.; Carvalho, D. A.; Cardoso, E. C. V.; Rassi, F. C.; Mundim, K. C.; Rubim, J. C.; Suarez, P. A. Z. *J. Anal. Appl. Pyrolysis* **2004**, *71*, 987.
- (332) Schwab, A. W.; Dystra, G. J.; Selke, E.; Sorenson, S. C.; Pryde, E. H. *J. Am. Oil Chem. Soc.* **1988**, *65*, 1781.
- (333) Milne, T. A.; Evans, R. J.; Nagle, N. *Biomass* **1990**, *21*, 219.
- (334) Twaiq, F. A.; Zabidi, N. A. M.; Bhatia, S. *Ind. Eng. Chem. Res.* **1999**, *38*, 3230.
- (335) Billaud, F.; Dominguez, V.; Broutin, P.; Busson, C. *J. Am. Oil Chem. Soc.* **1995**, *72*, 1149.
- (336) Monnier, J.; Tourigny, G.; Soveran, D. W.; Wong, A.; Hogan, E. N.; Stumborg, M. USA 5705722, Natural Resources Canada, 1998.
- (337) Aalto, P.; Piirainen, O.; Kiiski, U. Finnish Patent 19971031, Nestey Oy, Finland, 1997.
- (338) Craig, W. K.; Soveran, D. W. U.S. Patent 4992605 USA, 1991.
- (339) Stumborg, M.; Wong, A.; Hogan, E. *Bioresour. Technol.* **1996**, *56*, 13.
- (340) Wong, A.; Hogan, E. *Biomass: A Growth Opportunity in Green Energy and Value-Added Products*, Conference on August 29, 1999–September 2, 1999, Elsevier: Oakland, CA; p 837.
- (341) Dunn, R. O. In *The Biodiesel Handbook*; Knothe, G., Krahl, J., Gerpen, J. V., Eds.; AOCS Press: Champaign, IL, 2005.
- (342) Hirai, T.; Ikenaga, N.; Miyake, T.; Suzuki, T. *Energy Fuels* **2005**, *19*, 1761.
- (343) Haven S. Kesling, J.; Karas, L. J.; Frank J. Liotta, J. U.S. Patent 5308365, ARCO Chemical Technology, 1994.
- (344) Klepacova, K.; Mravec, D.; Bajus, M. *Appl. Catal. A* **2005**, *294*, 141.
- (345) Wyman, C. E. *Annu. Rev. Energy Environ.* **1999**, *24*, 189.
- (346) Elliott, D. C.; Schiefelbein, G. F. Preprints of Papers—American Chemical Society, Division of Fuel Chemistry, 1989; Vol 34; p 1160.

CR068360D