

Multiband and Wideband Antennas for Mobile Communication Systems

Mustafa Secmen

*Electrical and Electronics Engineering Department, Yasar University
Turkey*

1. Introduction

The popularity of mobile communication systems has increased remarkably during the last decade and the market demand still continues to increase. As a fundamental part of these systems, antenna is one of the most important design issues in modern mobile communication units. Although there are several similar definitions, an antenna can be mainly described as a device, which transforms the electromagnetic waves in an antenna to radiating waves in an unbounded medium such as air in transmitting mode and vice versa in receiving mode. Because antennas are dependent on frequency, they are designed to operate for certain frequency bands.

The rapid growth of mobile communication systems has forced to the use of novel antennas for base and mobile station applications (mobile phone, notebook computer, personal digital assistants (PDA), etc.). Earlier, mobile systems were designed to operate for one of the frequency bands of 2G (second generation) systems, which are Digital Cellular System (DCS), Personal Communications Service (PCS) and Global System for Mobile Communications (GSM) networks. Currently, many mobile communication systems use several frequency bands such as GSM 900/1800/1900 bands (890-960 MHz and 1710-1990 MHz); Universal Mobile Telecommunication Systems (UMTS) and UMTS 3G expansion bands (1900-2200 MHz and 2500-2700 MHz); and Wi-Fi (Wireless Fidelity)/Wireless Local Area Networks (WLAN) bands (2400-2500 MHz and 5100-5800 MHz) where the list of frequently used frequency bands is given in Table 1 (Best, 2008).

Conventionally, because a single antenna can not operate at all of these frequency bands of mobile communication, multiple different antennas covering these bands separately should be used. However, usage of many antennas is usually limited by the volume and cost constraints of the applications. Therefore, multiband and wideband antennas are essential to provide multifunctional operations for mobile communication. A multiband antenna in a mobile communication system can be defined as the antenna operating at distinct frequency bands, but not at the intermediate frequencies between bands. For example, a triple band antenna for GSM 900/1800/1900 bands can cover the frequency bands 890-960 MHz and 1710-1990 MHz (Ali et al., 2003); however, it does not operate properly at the frequencies such as 1200 MHz or 2500 MHz. On the other hand, a wideband antenna operates at every frequency points within a given frequency band. For example, a wideband antenna covering UMTS, extended UMTS and WLAN 2400 bands functions at every frequency points

between 1900 and 2700 MHz (Secmen & Hizal, 2010; Caso et al., 2010). At this point, the readers may wonder what “the antenna operates at this frequency properly” means. This chapter follows in the brief explanation of this question by describing crucial antenna parameters for mobile communication systems. Afterwards, this chapter provides types and examples of multiband antennas used in mobile communication. Finally, wideband antennas are investigated in the last section of this chapter.

| Wireless Application | Alternate Description(s) | Frequency Band (MHz) |
|---------------------------------|--|----------------------|
| GSM 850 | AMPS (Advanced Mobile Phone System) | 824-894 |
| GSM 900 | | 890-960 |
| GPS (Global Positioning System) | | 1565-1585 |
| GSM 1800 | DCS 1800 | 1710-1885 |
| GSM 1900 | PCS 1900; CDMA 1900 (Code Division Multiple Access) | 1850-1990 |
| UMTS | W-CDMA (Wideband Code Division Multiple Access); IMT 2000 (International Mobile Telecommunication) | 1885-2200 |
| Extended UMTS | LTE 2600 (Long Term Evolution); WiMAX (Worldwide Interoperability for Microwave Access) 2500 | 2500-2690 |
| Wi-Fi/WLAN (IEEE 802.11 b/g/n) | ISM 2450 (Industrial, Scientific and Medical) | 2400-2484 |
| Wi-Fi/WLAN (IEEE 802.11 y) | | 3650-3700 |
| Wi-Fi/WLAN (IEEE 802.11 a/h/j) | HIPERLAN (High Performance Radio Local Area Network); U-NII (Unlicensed National Information Infrastructure) | 5150-5825 |

Table 1. The frequency bands for mobile communication applications

2. Main antenna parameters for mobile communication systems

In antenna terminology, the frequency bandwidth of an antenna is generally characterized either with the lower and upper limits of frequency band (f_L and f_u) or the percentage (%) bandwidth for a center frequency, which is given as:

$$\% \text{ bandwidth} = \frac{f_u - f_L}{f_c} \times 100 \quad (1)$$

where f_c is the center frequency of the band as the arithmetic mean of lower and upper frequency limits. The bandwidth of an antenna is defined as the frequency range which the

performance of antenna satisfies specified standards of some antenna parameters (Balanis, 2005). Therefore, in order to operate properly at the specified frequency bandwidth, the antenna should meet the given standards of these parameters for all frequencies within the frequency bandwidth. Although there are many parameters for different antenna applications, only the important ones regarding to the performance standards for mobile communication systems are mentioned briefly here.

2.1 Input impedance

Depending on the impedance of the antenna and the line feeding the antenna, a certain fraction of transmitted power to the antenna reflects from antenna without radiation. This power fraction is usually described as the return loss (RL) (or sometimes called as mismatch loss) in decibel scale as

$$RL(dB) = -20 \log |\Gamma| \quad (2)$$

where Γ is the reflection coefficient which is given by

$$\Gamma = \frac{Z_{ANT} - Z_0}{Z_{ANT} + Z_0} \quad (3)$$

where Z_{ANT} is the complex input impedance of the antenna and Z_0 is the impedance of feeding line. As the alternative way of describing the reflected power from the antenna, the term of voltage standing wave ratio (VSWR) is also used with a formal definition given by

$$VSWR = \frac{1 + |\Gamma|}{1 - |\Gamma|} \quad (4)$$

VSWR provides a more quantitative indication about mismatch between the antenna and feeding line impedances that $VSWR = 1$ indicates perfect matching.

Because the complex impedance of antenna is a function of frequency, both return loss and VSWR depend on the operating frequency. Thus, if the antenna operates at a given frequency bandwidth, the impedance of the antenna should satisfy application-specific criterion such as $VSWR \leq 2$ or equivalently $RL \geq 10$ dB at all frequencies within the bandwidth. In base station systems, the constraint of $VSWR \leq 2$ (or sometimes shown as VSWR 2:1) is usually sufficient, which corresponds to about 10% reflected power from the antenna. On the other hand, mobile station antennas such as handheld antennas are typically designed to have $VSWR \leq 3$ for multiband systems due to very tight volume constraints (Rahmat-Samii et al., 2008).

2.2 Radiation pattern and beamwidth

An antenna radiation pattern is defined as a graphical representation of power distribution or field strength of the antenna as a function of space coordinates. These coordinates are usually selected as elevation (θ) and azimuth (ϕ) angles of spherical coordinate system. There are many types of representation of radiation pattern of an antenna. One of them is the three dimensional (3D) graph whose examples can be found in many antenna books (Balanis, 2005). However, the drawing of 3D graph is usually difficult and unnecessary due to the symmetry of antenna radiation pattern. Therefore, instead of 3D radiation pattern, a

more comprehensive representation of radiation pattern called as polar plot is used. Polar plot is actually a planar cut from 3D radiation pattern as shown in Fig. 1(a). Same pattern can be presented in the rectangular plot, as shown in Fig. 1(b). Both patterns are normalized to the pattern's peak, which is pointed to $\theta = 0$ in this case and given in decibel scale.

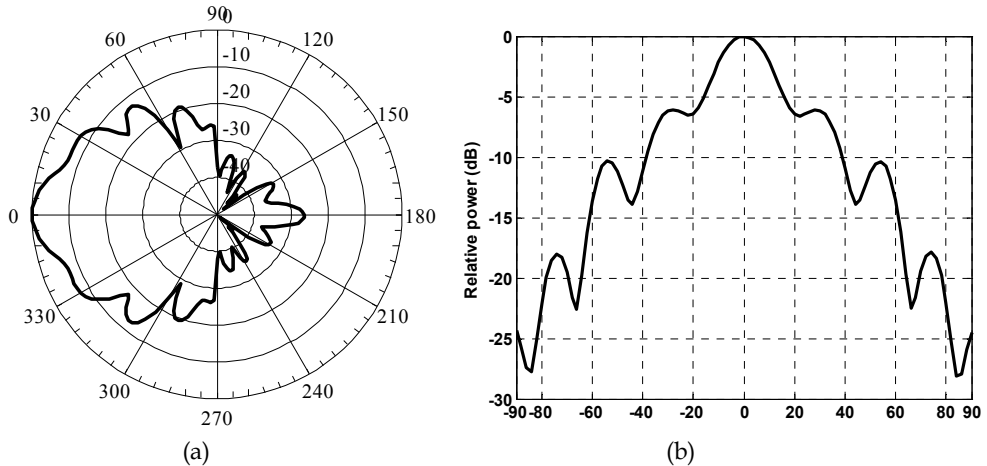

Fig. 1. (a) Polar plot and (b) Rectangular plot representation of radiation pattern

In antenna terminology, planar cuts from 3D pattern are considered for two main planes, which are E-plane and H-plane for linearly polarized antennas. The E-plane is defined as the plane containing the electric field vector and the direction of maximum radiation; and H-plane is the plane containing the magnetic field vector and the direction of maximum radiation. Therefore, by representing plots of an antenna in both planes, which are orthogonal, power distribution of the antenna in whole space can be comprehended well without drawing 3D pattern.

The beamwidth of the antenna is defined as the angular distance (width) between two half power points in the radiation patterns, where half power level is 3 dB below than maximum radiation power. The beamwidth parameter is usually expressed as "3 dB beamwidth" in the antenna applications for both E plane (elevation beamwidth) and H plane (azimuth beamwidth). This parameter can be also considered as effective angular width of the antenna that important portion of radiated antenna power is focused within this angular beamwidth. Theoretically, omnidirectional (equal radiation at all directions) pattern in azimuth plane and wide beamwidth in elevation plane are desired for mobile units. Practically, mobile handset antennas may have very wide beamwidth such as 180° in both planes. In indoor or outdoor base station applications, antennas having wide 3 dB beamwidth (90° or 120°) are preferred to provide sufficient angle coverage in azimuth plane; whereas, the elevation beamwidth of these antennas varies typically between 10° or 70° within the frequency bandwidth of the antenna. GSM systems with three-sector configuration typically use antennas having 3 dB beamwidth of 65° (Collins, 2009).

When radiation pattern of an antenna is handled, the front-to-back (F/B) ratio of antenna is also an important parameter in mobile communication applications. This parameter is roughly defined as the ratio of maximum radiated field in forward (mainlobe) direction (0°

in Fig. 1(a)) to the radiated field in the opposite (backlobe) direction (180° in Fig. 1(a)). This ratio is generally desired to be about 30 dB in outdoor base station applications in order to minimize the interference between back-to-back oriented antennas. On the other hand, the required F/B ratio for indoor applications can be low (Secmen & Hizal, 2010). In mobile phone antennas, the backlobe radiation is usually directly oriented to the head of a human body; therefore, this radiation level is desired to be as low as possible corresponding to high F/B ratio. In notebook computer antennas, the desired radiation pattern is omnidirectional; consequently, F/B ratio should be low that the antennas with F/B ratio of 0.5 dB can be employed by using symmetric patch antenna structures (Guterman et al., 2006).

2.3 Gain

The gain of an antenna is defined as the ratio of the power intensity radiated by the antenna in a given direction (usually in spherical coordinate angles θ and ϕ) divided by the intensity radiated by a lossless isotropic antenna, which radiates the power at all angles equally. In a mathematical form, it can be formulated as

$$gain = G(\theta, \phi) = 4\pi \frac{U(\theta, \phi)}{P_{in}} \quad (5)$$

where $U(\theta, \phi)$ is the radiation (power) intensity and P_{in} is total input (accepted) power of the antenna. In antenna applications, gain is usually considered as maximum gain taken in the direction of maximum radiation. Therefore, gain drops at most 3 dB below maximum gain within the beamwidths of the antenna. Gain requirements may vary according to different applications of mobile communication. For example, in outdoor base station applications, the standard gain requirement is generally between 10 and 20 dBi (dBi: gain in dB scale relative to isotropic antenna) within frequency bandwidth, which is usually achieved with array structures (Arai, 2002). For indoor mobile communication, moderate gain (5-7 dBi) is usually sufficient (Serra et al., 2007; Secmen & Hizal, 2010). However, the gain of the antenna may decrease even to 1 dBi within the designated frequency band for handset applications (Rahmat-Samii et al., 2008).

2.4 Polarization

The polarization of the antenna is roughly defined as the orientation of electric field vector of the radiated wave of the antenna with time. While the electric field in linearly polarized wave oscillates in either horizontal or vertical directions, it circulates around direction of propagation vector in circularly polarized wave. In order to transfer maximum power between transmitter and receiver antennas, both antennas should have same polarization. However, in general, the polarization of receiver antenna is not the same as the polarization of the incident wave radiated by transmitter antenna. Consequently, power transfer is reduced, which is called as polarization loss factor (PLF). Mathematically, this loss is expressed in decibel scale as (Balanis, 2005).

$$PLF(dB) = 20 \log(\vec{\rho}_r \cdot \vec{\rho}_t) \quad (6)$$

where $\vec{\rho}_r$ and $\vec{\rho}_t$ are unit (polarization) vectors of receiver and transmitter antenna, respectively. Accordingly, when the case, where linearly polarized transmitter and receiver

antennas are orthogonally oriented, is considered; no power is transferred theoretically between antennas. Therefore, a single linearly polarized antenna can not be used directly in mobile communication systems such as base station application that another linearly polarized receiver antenna, i.e. a mobile phone antenna, can be hold in any tilted position even orthogonal to base station antenna and this case results in zero transferred power. On the other hand, in circular polarization case, there exists no complete power loss (mismatch) that some portion of transmitted power is always transferred to linearly polarized receiver antenna for any spatial orientation. For this purpose, circular polarization is frequently used in mobile communication systems in order to prevent complete mismatch (Haapala et al., 1996; Wong et al., 2002). However, achieving circular polarization within wide frequency bandwidth is difficult; therefore, as compared to linearly polarized antennas, circularly polarized antennas in mobile communication systems have relatively narrow frequency bandwidth. Consequently, in order to optimize polarization mismatch and frequency bandwidth, dual-polarized antenna systems, which include either two orthogonal linearly polarized antennas (Secmen & Hizal, 2010) or an antenna excited by two orthogonal feeds (Guo et al., 2002), are commonly used in base station applications. Moreover, dual-polarized antennas can provide space-saving polarization diversity at the base station point to increase the performance of mobile systems that $\pm 45^\circ$ dual-polarized (slant-polarized) antennas are currently in almost universal use for base station systems (Caso et al., 2010).

2.5 Mutual coupling

When identical antenna elements are placed in an array or multiple different antennas are used, they interact with each other. This interaction between elements due to their close proximity is called mutual coupling, which affects the input impedance as well as the radiation pattern. It is noted previously that in base station applications, more than one similar antenna can be implemented to either acquire higher gain with array structures or at least provide dual-polarization with two antenna elements or feeds. Furthermore, in mobile station applications, even multiple different antennas can be used in a limited available space to provide multiband operation (Boyle & Massey, 2006). For these antenna systems, the mutual coupling is simply defined as the interference value between two antenna elements or feeds, which is desired to be as low as possible. Mathematically, in N element antenna system, the mutual coupling S_{ij} in between i th and j th antenna elements can be evaluated in decibel scale as

$$S_{ij} \text{ (dB)} = 20 \log \left. \frac{b_i}{a_j} \right|_{a_k=0 \text{ for } k \neq j} \quad (7)$$

where a_i is the amplitude of transmitted wave from j th antenna and b_i is the amplitude of received wave from i th antenna that transmitted waves on all other antennas except j th antenna are set to zero. In base station systems, the specification for mutual coupling between antenna elements is typically -20 dB (or 20 dB isolation) within the frequency bandwidth. The mutual coupling effect in these systems using polarization diversity (one antenna with two orthogonal feeds) is usually higher than the systems using spatial diversity (different antennas). As for mobile station applications such as mobile phone or

notebook computer antennas, the mutual coupling requirement may increase up to -10 dB (Rahmat-Samii et al., 2008).

2.6 Cross polar discrimination

Most dual polarized antenna systems employed for polarization diversity purpose are demanded that each antenna port receives signals only from its designated linear polarization (co-polarization). However, unfortunately practical antennas also receive unwanted signals from orthogonal polarization called as cross polarization (X-polarization). Cross polar discrimination is the ratio of received co-polar signal level to cross polar signal level. In order to show the cross polar discrimination, radiation patterns (co-polar and cross polar) of an indoor mobile communication antenna are given in Fig. 2 for both principal planes (Secmen & Hizal, 2010). According to this figure, the cross polar discrimination values are approximately 30 dB in the boresight direction (90° in Fig. 2). However, as shown in the patterns, providing constant cross polarization discrimination within beamwidth is difficult that this value falls to 20 dB for 60° degrees in principal H-plane. Nevertheless, cross polar discrimination needed to provide polarization diversity is not large that typical cross polar discrimination requirement for the mobile communication systems is around 25 dB in the boresight direction and 10 dB at the edges of beamwidth (Collins, 2009).

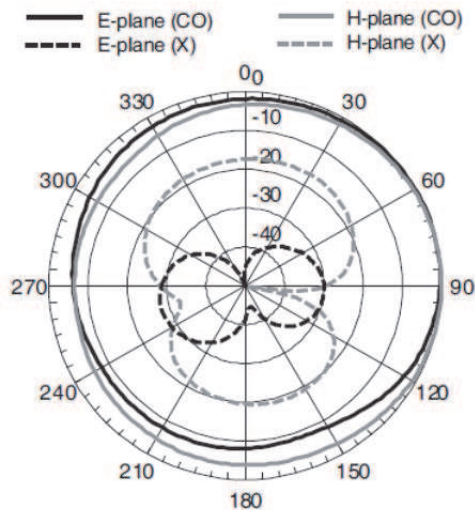

Fig. 2. The radiation patterns in both planes for an indoor base station antenna system where CO and X indicate co-polarization and cross-polarization (Secmen & Hizal, 2010)

2.7 Intermodulation

When the signals with multiple frequencies (f_1, f_2, \dots, f_n) are received by a nonlinear device, intermodulation frequency terms ($f_1-f_2, f_1+f_2, 2f_1-f_2, \dots$) are generated. Although an antenna is actually a linear device, it may slightly deviate from linearity when sufficiently high power is transmitted or received by the antenna. This nonlinearity is usually formed due to mechanical joints or nonlinear materials used in the antenna. The intermodulation level is crucial especially in base station applications that the intermodulation frequencies can

degrade the performance of the communication system. The intermodulation frequency terms may easily fall inside the frequency band of interest. For example, two transmitted frequencies ($f_1 = 935$ MHz and $f_2 = 955$ MHz) in frequency band of GSM 900 can generate 3rd order intermodulation term at the frequency, $2f_1 - f_2 = 915$ MHz, which again falls into GSM 900 band. Therefore, the intermodulation levels are desired to be as low as possible that typical signal level for base station applications is between -180 dBc and -120 dBc (dBc: power in dB scale relative to carrier power). On other hand, when mobile station systems such as mobile phone or notebook computer are considered, the intermodulation issue is not so serious that the power handled in these systems is not as high as generating remarkable intermodulation frequency terms. Therefore, intermodulation terms are usually ignored in these applications.

2.8 Specific Absorption Rate (SAR)

For a mobile phone or notebook computer antenna located to the position, which is nearby to a human body, some portion of transmitted power is absorbed by the human body. The specific absorption rate (SAR) is basically defined as the absorbed power density at a particular point of the human body. SAR can be quantitatively expressed as (Huang & Boyle, 2008)

$$SAR = \frac{dP_{abs}}{\rho dV} = \frac{\sigma |E|^2}{2\rho} \quad (8)$$

where dP_{abs} is absorbed power within an infinitesimal volume of dV ; E is the peak electric field strength within dV ; ρ and σ are mass density and conductivity of the human body. SAR is important that certain regulations about SAR, which are based on the biological effects of thermal heating due to radiation, should be satisfied. The IEEE standard about SAR indicates that maximum allowed 1-g averaged maximum SAR is 1.6 W/kg and whole-body averaged peak SAR is 0.08 W/kg. 10-g averaged maximum SAR value is commonly used as 2 W/kg in Europe countries.

3. Multiband antennas for mobile communication

In order to realize multiband operation, a wide variety of antenna types, which uses different multiband techniques, is used. Fundamental multiband techniques will be explained in the following part of this section. Next, basic multiband antenna types designed for mobile communication systems will be given.

3.1 Multiband techniques

3.1.1 Higher order resonances

One of the basic ways of getting multiband operation is to utilize from higher order resonances. This principle is explained in Fig. 3 that a monopole antenna is often used with a length of $\lambda/4$ (Fig. 3(a)). For this case, the antenna resonates at f_0 with electric field minimum at the feed. However, a similar condition of minimum electric field at the feed also exists when same antenna's length corresponds to $3\lambda/4$ (Fig. 3(b)). Therefore, the monopole antenna can also resonate at $3f_0$. Other higher resonances also exist at higher frequencies such as $5f_0$. Higher order resonances are used in many types of antennas such as dipoles, helices, patches and slots. In (Huang & Boyle, 2008), a normal mode helical antenna

mounted on a typical mobile phone is given. According to the results, the antenna has the resonances at frequencies f_0 and $2.6f_0$ that higher order resonances principle almost holds for this case.

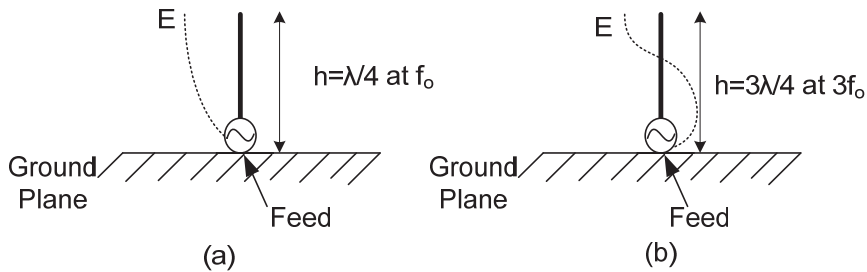

Fig. 3. (a) A monopole antenna resonating at f_0 (b) Same antenna resonating at $3f_0$ (E is the electric field magnitude)

3.1.2 Multiple resonant structures

The most popular technique for obtaining multiband antenna system is the usage of multiple resonant structures. Here, two or more resonant structures, which are closely located in space or even co-located with a single feed, are used. This is illustrated in Fig. 4 for dual-band applications that the antennas in both cases have operation center frequencies f_1 and f_2 . They are typical examples for corporate feed that two resonant structures are excited simultaneously. On the other hand, sometimes multiple resonant structures can be fed in series way as shown in Fig. 7(b) that the second resonant structure can be excited after the first structure is excited.

The multiple resonant structure technique is also frequently used in mobile communication systems to achieve multiband mobile antennas. For example, in (Haapala et al., 1996), dual frequency antenna systems for handsets are proposed. The designed structures are the combination of monopole and helical antennas as shown in Fig. 4(b) that multiple resonances at two different frequencies are acquired for dual-band operation at GSM 900 and 1800 bands.

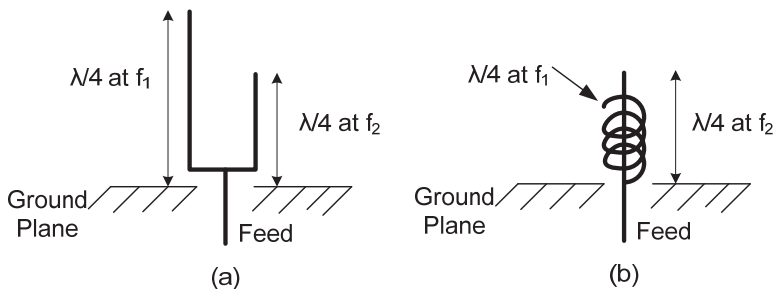

Fig. 4. (a) Two monopole antennas for dual-band operation (b) A helical antenna resonating at the frequency f_1 and a monopole antenna resonating at the frequency f_2 for dual-band operation

3.1.3 Parasitic resonators

Another method to obtain multiband characteristics is the implementation of parasitic resonators to the antenna system. In this technique, an extra parasitic element is added to the fed antenna for the operation at different frequency, but this element is not directly fed as in Yagi-Uda antenna (Balanis, 2005). It is parasitically coupled from near field of the antenna and resonates at another frequency. An example for this technique is given in Fig. 5 for a triple band application (Manteuffel et al., 2001). In this study, the antenna initially operates at GSM 900 and 1800 frequency bands without parasitic element. However, with the addition of the parasitic element, a triple band antenna for GSM 900, 1800 and 1900 frequency bands is realized.

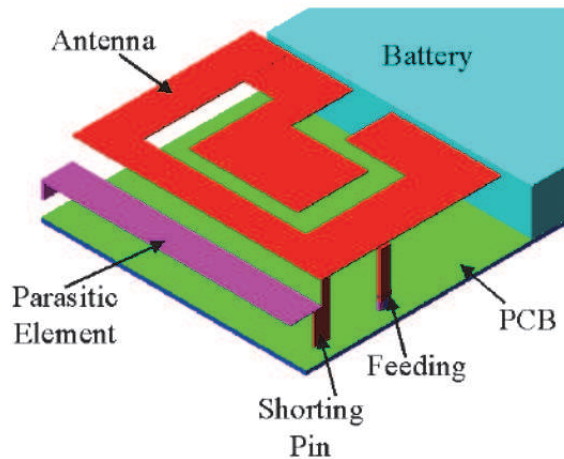

Fig. 5. A folded patch antenna with parasitic element for a triple band application (Manteuffel et al., 2001)

3.2 Monopole (whip) and helical antennas

One of the extensively used antennas in the earlier mobile communication systems is the monopole antenna and it is still used in applications such as United States CDMA networks. Monopole antennas have a very simple form containing a whip with height $\lambda/4$ above a ground plane, two of which are shown in Fig. 4(a) for possible dual-band operation. It has linear polarization characteristics and omnidirectional radiation pattern in H plane making this antenna an attractive choice especially for mobile unit applications. Several different forms of monopoles are given in Fig. 6 for a mobile handset system. However, since the size of ground plane greatly influences the radiation characteristics, it should be large in order to obtain ideal omnidirectional pattern. As a solution to this problem, sleeve dipole in Fig. 6(e) is an interesting antenna that it actually behaves as asymmetrically fed half-wave dipole with monopole like radiation. This antenna is used in private mobile handset systems such as emergency services. A dual-band sleeve dipole antenna operating at AMPS and GSM 1900 frequency bands can be found in (Ali et al., 1999) for a notebook computer application. These forms of monopoles in Fig. 6 have generally large heights for mobile communication systems. In order to reduce the height of the monopoles, several different wire type antennas such as helical, wound coil or folded loop antennas are used for multiband

operations (Katsibas et al., 1998; Lee et al., 2000). Among these antennas, helical antenna, which is given in Fig. 4(b) in conjunction with a whip for dual-band operation, is the most popular. While axial mode helical antenna provides endfire radiation (parallel to the axis of the helix) pattern and circular polarization, normal-mode helical antenna gives linear polarization and similar radiation pattern with monopole antenna. Some of dual-band helical antennas used in mobile station systems are given in Fig. 7, where the first design uses two helical antennas with different radii and the second design uses antennas with different pitches (Wong, 2003). As another application of helical antenna in mobile communication systems, an intelligent quadrifilar helical antenna for satellite mobile communications is presented in (Leach, 2000).

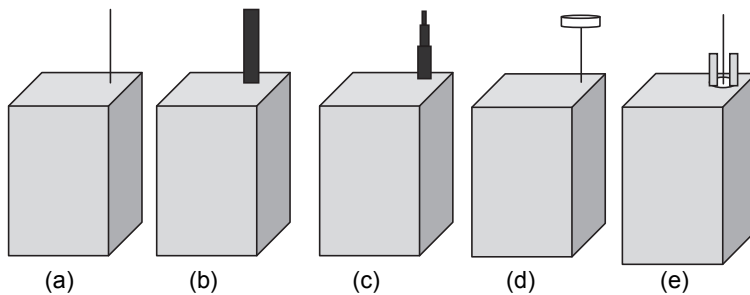

Fig. 6. (a) Wire monopole (b) strip monopole (c) retractable monopole (d) capacitive loaded monopole (e) sleeve dipole

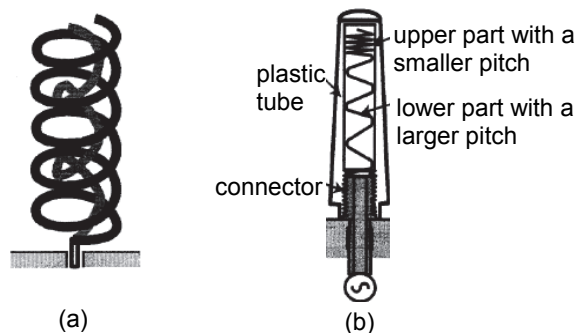

Fig. 7. (a) Two helical antennas with different radii (b) two helical antennas with different pitches (Wong, 2003)

In spite of their simple structures, all these monopole and helical antennas have still high dimensions especially for mobile station systems. Besides, these antennas can be considered as external antennas since they are usually mounted outside the mobile systems such as mobile handset, and external antennas are more sensitive to the position of nearby objects, for instance, head of a human (Rahmat-Samii et al., 2008). For these reasons, internal printed monopole antennas supplying lower profile and higher bandwidth for multiband operations are generally preferred. Some typical examples of internal printed monopole antenna for dual-band operation are given in Fig. 8 (Chen et al., 2001; Chen & Chen, 2004).

Both antennas in these studies provide return loss higher than 10 dB for GSM 1800 and WLAN 2400 bands.

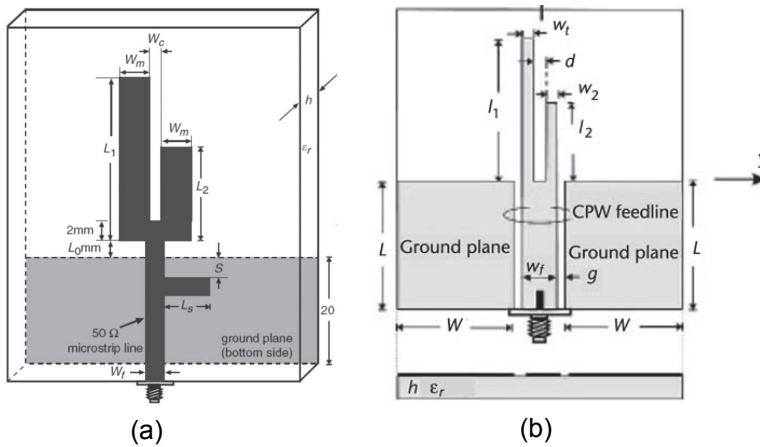

Fig. 8. (a) A microstrip fed dual-band printed monopole antenna (Chen et al., 2001) (b) A coplanar waveguide (CPW) fed dual-band printed monopole antenna (Chen & Chen, 2004)

3.3 Inverted F Antennas (IFA)

The classical monopole type antennas commonly require very large ground plane in order to have maximum radiation of the antenna parallel to the ground plane for principal E-plane. One possible solution for this problem can be to employ an antenna having maximum radiation towards normal to the ground plane; then, ground plane can be one side of the terminal. For this purpose, a quarter-wave monopole is first folded to form an inverted L antenna (ILA), and then it is modified to commonly known inverted F antenna (IFA) that the modification steps are given in Fig. 9 (Huang & Boyle, 2008).

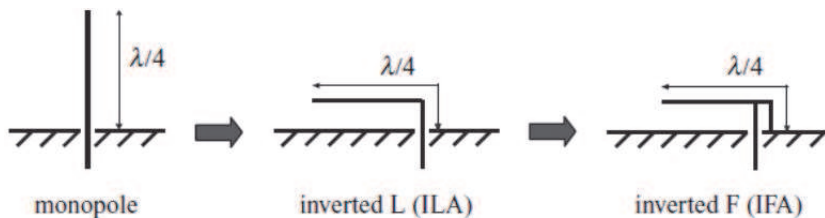

Fig. 9. Modification steps of IFA from monopole antenna (Huang & Boyle, 2008)

When IFA in this figure is investigated, with its image, the antenna appears as a two wire transmission line with a short circuit at the end. The IFA is widely used as an internal antenna especially in mobile handset and notebook computer applications. Many modifications have been made to IFA that IFAs operating at dual WLAN bands (2.4 and 5 GHz) have been proposed (Yeo et al., 2004). The printed forms of inverted L or F antennas are also very popular and widely used for multiband operations in mobile communication systems (Wong et al., 2003; Wang et al., 2007).

3.4 Planar Inverted F Antennas (PIFA)

In terms of mechanical reliability and elegance, internal antennas are preferred in mobile units. The planar inverted F antenna (PIFA) is the most typical internal antenna especially for mobile handset applications that most of antennas in current mobile units are small, multiband and modified PIFAs. As shown in Fig. 10, a planar inverted F antenna is achieved by short circuiting radiating patch to the antenna's ground plane with a shorting pin or plate. Although PIFA seems to be modified from IFA by just replacing radiating wire in IFA with radiating patch, both antennas have different radiation mechanisms. PIFA can be actually considered as a modification of half-wavelength long microstrip patch antenna.

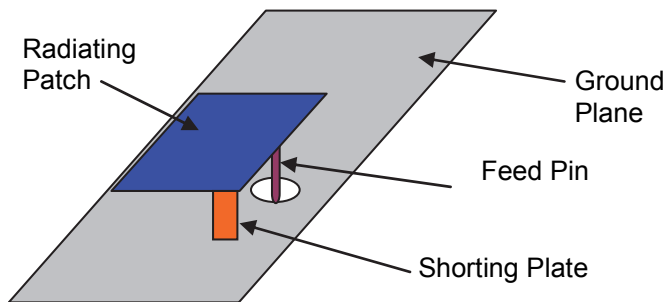

Fig. 10. Configuration of a typical planar inverted F antenna

Compared to the conventional external monopole antennas, PIFAs are less easily broken off. In addition, the ground plane in PIFA reduces the possible backward radiation, for instance, towards the head of a human, leading to lower SAR values. PIFA can resonate at a much smaller antenna size, which is desired and an attractive feature for mobile station applications. Furthermore, by cutting slots in the radiating patch, the resonance path can be modified; therefore, the antenna size can be further reduced. Besides, an intelligent design about the shape of the patch and the positions of the feed and shorting pins results in the existence of multiple resonance paths, causing multiband operations. A sample PIFA for dual-band operation is given in Fig. 11 (Boyle, 2008).

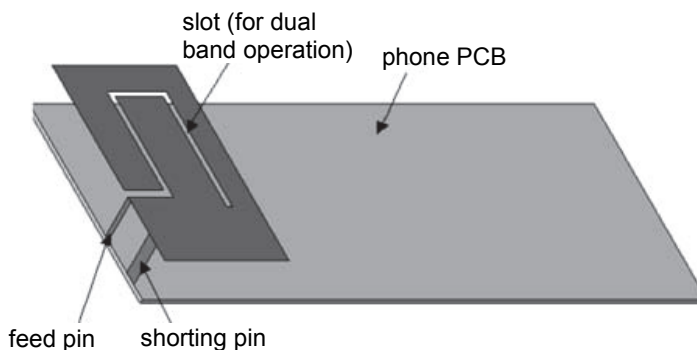

Fig. 11. A dual-band PIFA structure (Boyle, 2008)

The theory of this structure is investigated in detail in (Boyle, 2008). For the antenna in Fig. 11, it can be roughly explained that the inner part of this structure (slot) provides high frequency component of dual-band, whereas the outer part provides a low frequency component. Several PIFA antennas and their extended versions are reported for multiband operations including triple band (Manteghi & Rahmat-Samii, 2006), quad band (Ciais et al., 2004) and even six-band (Guo & Tan, 2004) for mobile communication systems. In (Manteghi & Rahmat-Samii, 2006), a compact triple band PIFA operating in WLAN 2400 (2.4-2.5 GHz) band and two different UNII bands (5.15-5.35 GHz and 5.7-5.85 GHz) is presented. As shown in Fig. 12(a), three different resonance frequencies are generated by adding J-shaped slot and a quarter wavelength slot on the radiating patch. The fabricated two element antenna array is also given in Fig. 12(b) that total size for the antenna part is approximately 50 mm x 13 mm x 4 mm. The proposed antenna provides return loss higher than 10 dB for the mentioned bands.

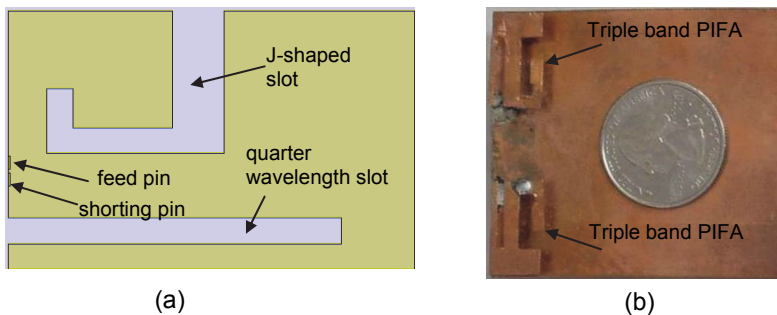

Fig. 12. (a) A triple band PIFA (b) Array of two elements of triple band PIFA (Manteghi & Rahmat-Samii, 2006)

The paper presented in (Ciais et al., 2004) uses several multiband techniques such as multiple resonant structures (cutting slots) and parasitic resonators in order to implement a quad band PIFA. This antenna covers GSM 900 band by providing VSWR less than 2.5 and GSM 1800, 1900 and UMTS bands by providing VSWR less than 2. The antenna in (Guo & Tan, 2004) proposes a compact PIFA with a parasitic plate and folded stub for mobile handsets. This antenna covers GSM 900, 1800, 1900; GPS, UMTS and ISM2450 bands with return loss better than 6 dB and it occupies only 36 x 17 x 8 mm³ total volume. There exist many different types of PIFA for mobile communication systems, which can be found in (Wong, 2003) for the readers interested in this antenna type.

3.5 Low profile antennas

The profile of a monopole (printed or planar antenna) or PIFA can be further reduced by some miniaturization techniques such as folded or meandered structures. The folded structures are mainly associated with bending, wrapping or folding of the monopole antennas into more complicated configurations such as S-shaped (Lui et al., 2004) or T-shaped structures (Chen et al., 2006). On other hand, a typical example for a single meandered structure is given for a printed monopole in Fig. 13 that meandered structures can be also combined with other configurations such as an inverted L-element in order to obtain multiband operation.

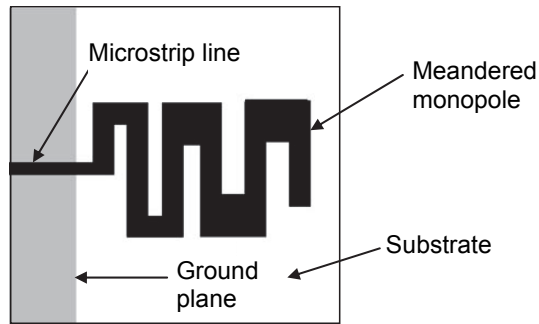

Fig. 13. A meandered printed monopole antenna

Low profile antennas have great importance due to its reduced size that for instance, this kind of low profile monopole in Fig. 13 is very suitable for integration within mobile phone applications as a built-in antenna. As the application of meandered type antenna, the antenna in (Ali et al., 2003) uses a driven meandered line element in addition to two parasitic structures for a triple band application of mobile phone handset. The antenna can be tuned to operate either in GSM 850, 900 and 1900 bands or GSM 850, 900 and 1800 bands by providing $VSWR \leq 2.5$ within the given frequency bands. In another realized antenna (Teng & Wong, 2002), a structure consisting of three meandered lines and wrapped into a compact rectangular box is presented for GSM 900, 1800 and 1900 frequency bands. The proposed antenna covers the required bandwidths of GSM 900, 1800 and 1900 by having $VSWR$ less than 2.5 and gain ranging from 1.4 to 3.6 dBi. In a relatively recent study (Jing et al., 2006), a compact multiband meandered printed antenna is represented. The mentioned antenna, whose geometry is given in Fig. 14, has actually three meandered monopoles, which can be considered as three radiating elements or branches. The first (through the path a-b-c-d) and second (through the path a-b-c-e) branches provide resonances at GSM 900 band. The third branch (through the path a-b-f) and additional branch (g-g') provide resonances at 2 GHz and WLAN 2400 band, respectively. According to the results, this antenna is found to operate in five different bands of GSM 900, 1800, 1900; UMTS 2000 and WLAN 2400 by giving $VSWR$ less than 2.5 and gain between about 1 and 3.2 dBi.

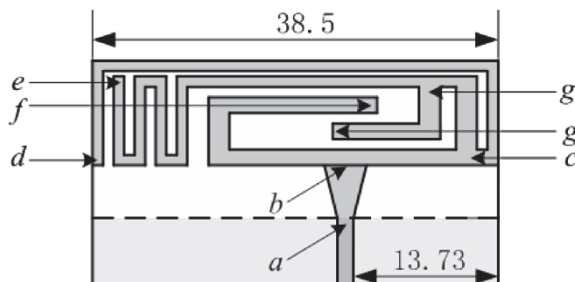

Fig. 14. A compact multiband meandered printed antenna (Jing et al., 2006)

As being another type for low profile antenna, folded structures have been reported in the literature. In the study in (Di Nallo & Faraone, 2005), a novel antenna structure, which can

also be called as folded inverted conformal antenna (FICA), has significantly higher bandwidth than a dual-band PIFA operating in GSM 900 and 1800 bands. Besides, it provides resonance at the third band around 2 GHz, which is suitable for UMTS applications. A special design of folded planar monopole is presented in (Lin, 2004) that the proposed antenna can cover GSM 900, 1800 and 1900; UMTS and ISM 2450 frequency bands with constraint of $VSWR \leq 2$.

Chip antennas, which can be also included in very low profile antennas, are frequently used in mobile station units such as mobile handsets. The chip antenna is a compact surface mountable device consisting of a high permittivity substrate (such as ceramic) and conducting patterns printed or embedded on it. Low temperature cofired ceramic (LTCC) technology is usually used that the substrate is composed of multilayered thin sheets, and the conducting strips are printed and connected on these sheets via metal posts. The metallic path can take different forms of helix, meander or spiral (Wong, 2003). There are two major types of chip antennas. The first one has a ground plane printed on the bottom of the substrate; however, it has generally narrow bandwidth and low radiation efficiency. For this purpose, in the most of today's chip designs, the chip antenna does not have an underlying ground plane as shown in Fig. 15 (Moon & Park, 2003). The chip part of the presented antenna has total volume of 48 mm^3 and operates at dual ISM bands (2.4 and 5.8 GHz) by providing $VSWR \leq 2$ within these frequency bands.

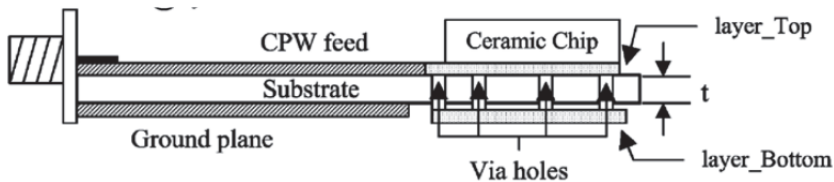

Fig. 15. The configuration of a dual-band chip antenna (Moon & Park, 2003)

4. Wideband antennas

In order to increase the bandwidth of an antenna, several methods such as using thick and low permittivity substrates, stacked and suspended structures, aperture or L-probe coupling, parasitic resonators and planar designs with different shapes (circular, triangular, etc.) can be considered. Wideband antennas normally occupy larger space than multiband antennas in the applications and the profile can be even higher with possible array configurations to obtain higher gain. Therefore, wideband antennas are mostly preferred in indoor or outdoor base station applications rather than mobile handset or notebook computer applications. Besides, while satisfying only VSWR (or return loss) requirement within the desired frequency bands is usually sufficient for mobile unit applications, additional criteria such as high gain and high isolation between the antenna elements should be satisfied for wideband antennas in base station applications. The commonly used wideband antennas in mobile communication systems are described as follows.

4.1 Microstrip patch antennas

Microstrip patch antenna is a well-known printed resonant structure consisting of a conducting patch, a substrate and a ground plane as shown in Fig. 16. Microstrip antenna's

patch shape can be any continuous shape such as square, rectangular, circular, ring and elliptical, where rectangular patch is the most common.

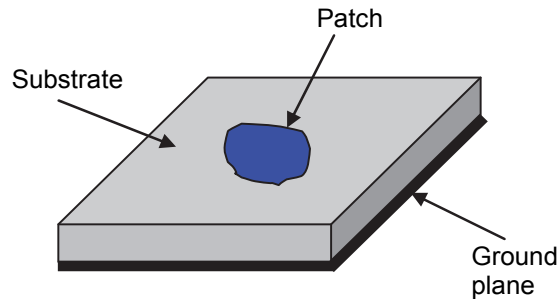

Fig. 16. Microstrip patch antenna configuration

This antenna is heavily preferred due to its low profile, lightweight, easy fabrication and being conformable to planar and nonplanar surfaces. With its original configuration, the antenna has narrow bandwidth, which is more suitable for multiband operations than some multiband patch antenna designs have been developed in literature (Chiou & Wong, 2003). However, by applying techniques such as using thick and low permittivity substrates, aperture coupling, stacked patches or cutting different shaped slots in the patch, its bandwidth can be widened, which makes them more convenient for base station applications. Wideband dual-polarized patch antennas have especially attracted much attention due to their ability of eliminating multipath fading. For example, the antenna in (Caso et al., 2010) proposes a dual-polarized microstrip antenna using both aperture coupling and stacked patch as wideband techniques. The geometry and fabricated view of the antenna are given in Fig. 17 that it operates between 1700 MHz and 2700 MHz (45 percent bandwidth), which includes GSM 1800, 1900; UMTS and extended UMTS; ISM frequency bands. Within the given bandwidth, the antenna provides return loss higher than 10 dB, isolation between ports higher than 22 dB and cross polar isolation higher than 20 dB. For a 2x1 array structure, the antenna gain is measured between 8 and 11 dBi in the entire band of interest, which is sufficient for most of the base station applications.

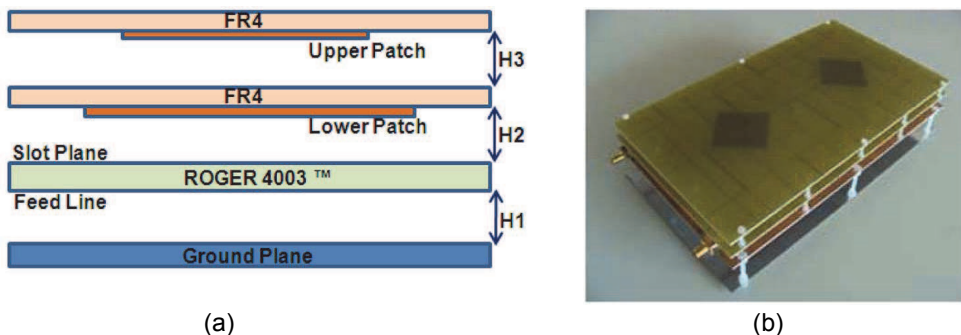

Fig. 17. (a) Stack-up view geometry of the single antenna element (b) Fabricated 2 x 1 prototype of the antenna (Caso et al., 2010)

4.2 Suspended plate antennas

A suspended plate antenna comprises from a thin plate conductor (patch) placed above a grounded low permittivity dielectric substrate (usually air) as shown in Fig. 18. It is usually fed by L or T shaped probes or planar strips in order to increase the bandwidth. These antennas have common advantages of easy fabrication, low cost and large bandwidth.

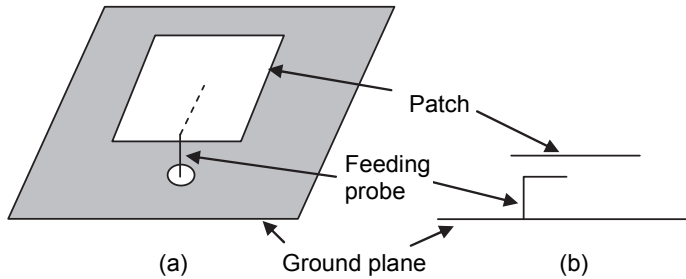

Fig. 18. (a) Isometric and (b) side views of the suspended plate antenna

There are many suspended plate antennas available for mobile communication systems. In (Secmen & Hizal, 2010), an inverted L-shape fed suspended plate antenna is designed for wideband indoor base station applications. The simulation and manufactured views of the proposed dual-polarized antenna are shown in Fig. 19. The antenna is initially fed with a

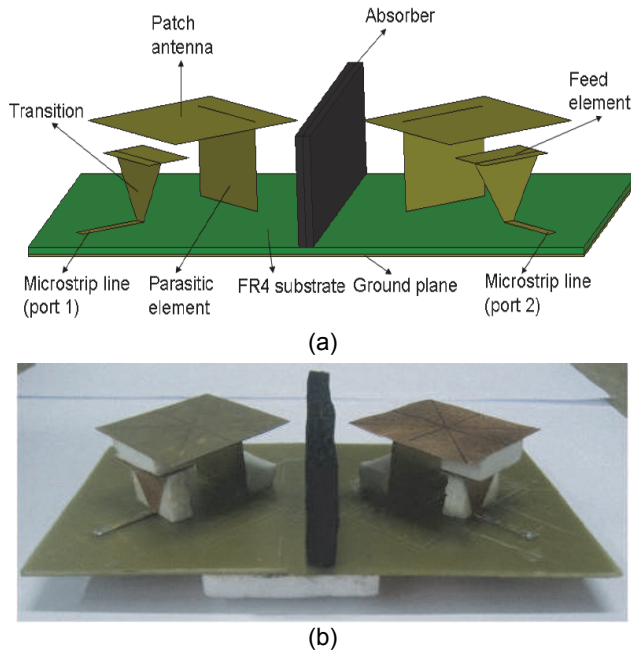

Fig. 19. (a) Simulation and (b) manufactured views of the suspended plate antenna in (Secmen & Hizal, 2010)

microstrip line instead of a probe, then with a bowtie transition, the incident power is transmitted to the suspended patch antenna via coupling from planar strip feed element. The antenna operates within the frequency bandwidth of 1900-2700 MHz (about 34 percent bandwidth) by performing return loss higher than 15 dB, isolation higher than 22 dB and cross polar discrimination in the boresight higher than 25 dB. Besides, the antenna has sufficiently wide 3-dB beamwidth values in both principle planes (minimum 66 degrees for E-plane and 125 degrees for H-plane); therefore, the proposed antenna can be used for indoor mobile communication applications.

4.3 Dielectric resonators

A dielectric resonator antenna (DRA) is mainly composed of a block of dielectric material on a conducting ground plane as shown in Fig. 20, where different geometrical shapes like hemisphere and rectangular instead of circular cylinder are available for DRA. DRA has some superiority over microstrip and printed antennas such as low profile, lightweight and small size. Besides, since there exists no radiating metal patch on the antenna, there is no conduction loss and this brings relatively lower loss compared with the microstrip

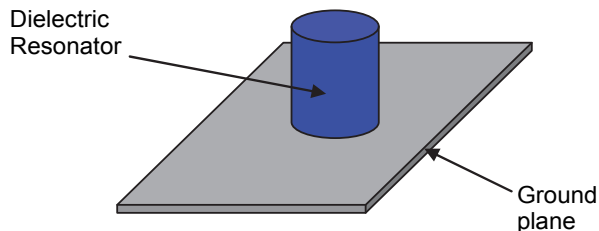

Fig. 20. A circular cylindrical dielectric resonator antenna on a ground plane

antenna especially for higher millimeter wave frequencies. Therefore, in mobile communication systems, it is usually used in WLAN applications, which have relatively higher frequencies (2400, 3600 or 5100 MHz) than GSM frequency bands. DRA also has the advantage of easy, simple and flexible excitation through the use of a coaxial probe, a microstrip line, an aperture coupling. For these reasons, DRA is increasingly popular and attractive to the researchers studying on mobile communication antennas. The resonance frequencies of a DRA are predominantly determined by its size and shape, and dielectric constant of the material (ϵ_r) that the dimensions can be significantly reduced by selecting materials with high dielectric constant. However, in order to maintain thermal stability, materials with dielectric constants lower than 30 are selected (i.e., ceramic with $\epsilon_r=9.2$). But, since the dimensions of the antenna can be still large at mobile communication frequency bands, many advanced designs have been developed in order to reduce the dimension with small ϵ_r values (Lan et al., 2003). DRAs are commonly used in wideband WLAN applications that many recent studies are available in the literature. For example, in (Mahender et al., 2010), a wideband U-shaped dielectric resonator antenna for WLAN application is given, which performs return loss higher than 10 dB and gain higher than 6.2 dBi for the frequency bandwidth 5.1-6 GHz including two different bands (5.15-5.35 GHz and 5.725-5.825 GHz) of a WLAN system. In a newly reported study (Brar & Sharma, 2011); a wideband aperture coupled pentagon shape DRA is presented for WiMAX (Worldwide Interoperability for Microwave Access) applications as shown in Fig. 21. The antenna operates from 2.55 GHz to

3.9 GHz (42 percent bandwidth) covering almost two WiMAX (2.5-2.7 GHz and 3.3-3.8 GHz) frequency bands. The antenna has return loss higher than 10 dB; gain higher than 3 dBi and moderation cross polarization levels within the given bandwidth.

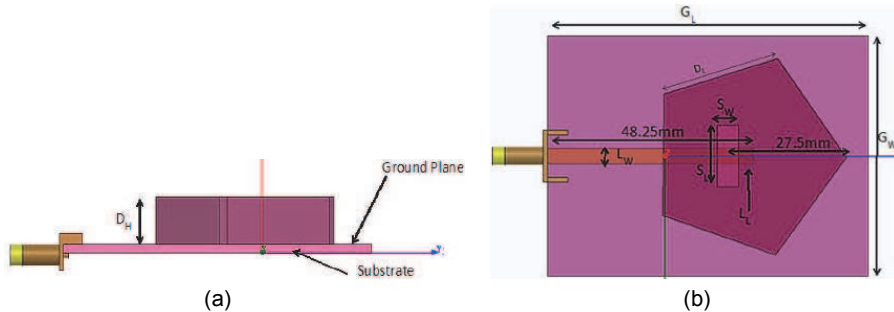

Fig. 21. (a) Side view and (b) top view of the antenna presented in (Brar & Sharma, 2011)

4.4 Planar monopoles

One of the basic approaches to making an electrically small antenna wideband is to make it plump. Therefore, in order to increase the bandwidth of a simple whip type monopole antenna, the radiating wire element should be replaced by planar elements in order to be more convenient for wideband applications. These planar elements can be square, rectangular, trapezoidal, cross-plate or conical shapes. For example, in (Wong et al., 2005), a square planar monopole with three-branch feeding strip is introduced with a bandwidth of about 10 GHz (about 1.4-11.4 GHz) that these antennas are usually called as ultra-wideband (UWB) antennas. Although these planar monopoles are comparably larger than the other wideband antennas described above, they are mostly preferred in mobile communication systems due to its very wideband characteristics. As an example, a wideband dual-sleeve monopole antenna with cone shape is presented in (Zhang et al., 2011) for indoor base station applications. The structure of the antenna is shown in Fig. 22 that by a top-loading circular patch shorted to the ground plane through four shorting probes, a significant size reduction is achieved. The antenna's impedance bandwidth for $VSWR \leq 2$ is calculated to be from 730 to 3880 MHz, which covers GSM 900, 1800, 1900; UMTS and extended UMTS, WLAN 2400 and 3600 bands. Because the antenna's gain is considerably low (from 2.5 to 6.7 dBi within the bandwidth), it is more suitable for indoor applications rather than outdoor applications, which needs higher gain.

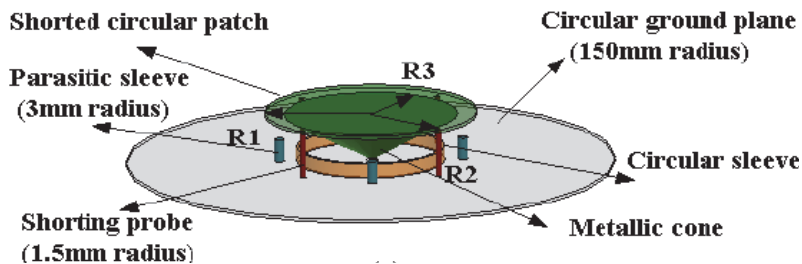

Fig. 22. The structure of the proposed antenna in (Zhang et al., 2011)

5. Conclusions

The explosive demand for mobile communication and information transfer using personal devices such as mobile phone or notebook computer has caused the need for major advancements of antenna design. With the development of 3G and even 4G technologies, multiband and wideband antennas operating at additional frequency bands such as UMTS and LTE are required. In this chapter, it is initially presented the fundamental parameters of the antenna to be taken into account while designing an antenna and determining the operating frequency bands. Afterwards, types of multiband antennas, which are used especially in mobile units, are described. Here, the techniques to make an antenna convenient for multiband operations are given; then, different antennas such as monopoles, PIFAs are examined with several examples in the literature. In the last part, the types of wideband antennas (microstrip patch antenna, DRA or planar) used in mobile communication, which are more appropriate for base station or access point applications, are presented. In conclusion, the engineers interested in mobile communication acquire an initial comprehension about fundamentals and characteristics of multiband and wideband antennas used in mobile communication systems. The readers can utilize from the given references for more detail.

6. References

- Ali, M.; Okoniewski, M.; Stuchly, M. A. & Stuchly, M. M. (1999). Dual-Frequency Strip-Sleeve Monopole for Laptop Computers, *IEEE Transactions on Antennas and Propagation*, Vol. 47, No. 2, (February 1999), pp. 317-323, ISSN 0018-926X.
- Ali, M.; Hayes, G. J.; Hwang, H.-S. & Sadler, R. A. (2003). Design of a Multiband Internal Antenna for Third Generation Mobile Phone Handsets, *IEEE Transactions on Antennas and Propagation*, Vol. 51, No. 7, (July 2003), pp. 1452-1461, ISSN 0018-926X.
- Arai, H. (2002). Outdoor and Indoor Cellular/Personal Handy Phone System Base Station Antenna in Japan, In: *Handbook of Antennas in Wireless Communications*, L. C. Godara (ed.), 345-370, CRC Press, ISBN 0-8493-0124-6, New York, USA.
- Balanis, C. A. (2005). *Antenna theory: Analysis and Design*, John Wiley & Sons, Inc., ISBN 0-471-66782-X, New York, USA.
- Best, S. R. (2008). Electrically Small Multiband Antennas, In: *Multiband Integrated Antennas for 4G Terminals*, D. A. Sanchez-Hernandez (ed.), 1-32, Artech House, ISBN 978-1-59693-331-6, Boston, USA.
- Boyle, K. R. & Massey, P. J. (2006). Nine-Band Antenna System for Mobile Phones, *Electronics Letters*, Vol. 42, No. 5, (March 2006), pp. 265-266, ISSN 0013-5194.
- Boyle, K. R. (2008). Multiband Multisystem Antennas in Handsets, In: *Multiband Integrated Antennas for 4G Terminals*, D. A. Sanchez-Hernandez (ed.), 33-52, Artech House, ISBN 978-1-59693-331-6, Boston, USA.
- Brar, M. K. & Sharma, S. K. (2011). A Wideband Aperture-Coupled Pentagon Shape Dielectric Resonator Antenna (DRA) for Wireless Communication Applications, *IEEE International Symposium on Antennas and Propagation Society*, pp. 1674-1677, ISBN 978-1-4244-9561-0, Spokane, Washington D. C., USA, July 3-8, 2011.
- Caso, R.; Serra, A. A.; Rodriguez-Pino, M.; Nepa, P. & Manara, G. (2010). A Wideband Slot-Coupled Stacked-Patch Array for Wireless Communications, *IEEE Antennas and Wireless Propagation Letters*, Vol. 9, (October 2010), pp. 986-989, ISSN 1536-1225.

- Chen, H.-D & Chen, H.-T. (2004). A CPW-Fed Dual-Frequency Monopole Antenna, *IEEE Transactions on Antennas and Propagation*, Vol. 52, No. 4, (April 2004), pp. 978-982, ISSN 0018-926X.
- Chen, H.-M.; Lin, Y.-F.; Kuo, C.-C. & Huang, K.-C. (2001). A Compact Dual-Band Microstrip-Fed Monopole Antenna, *IEEE International Symposium on Antennas and Propagation Society*, pp. 124-127, ISBN 0-7803-7070-8, Boston, USA, July 8-13, 2001.
- Chen, S.-B.; Jiao, Y.-C.; Wang, W. & Zhang, F.-S. (2006). Modified T-Shaped Planar Monopole Antennas for Multiband Operation, *IEEE Transactions on Microwave Theory and Techniques*, Vol. 54, No. 8, (August 2006), pp. 3267-3270, ISSN 0018-9480
- Chiou, T.-W. & Wong, K.-L. (2003). A Compact Dual-Band Dual-Polarized Patch Antennas for 900/1800-MHz Cellular Systems, *IEEE Transactions on Antennas and Propagation*, Vol. 51, No. 8, (August 2003), pp. 1936-1940, ISSN 0018-926X.
- Ciais, P.; Staraj, R.; Kossias, G. & Luxey, C. (2004). Design of an Internal Quad-Band Antenna for Mobile Phones, *IEEE Microwave and Wireless Component Letters*, Vol. 14, No. 4, (April 2004), pp. 148-150, ISSN 1531-1309
- Collins, R. (2009). Base Station Antennas for Mobile Radio Systems, In: *Antennas for Base Stations in Wireless Communications*, Z. N. Chen & K.-M. Luk (eds.), 31-93, Mc-Graw Hill, ISBN 978-0-07-161289-0, New York, USA.
- Di Nallo, C. & Faraone, A. (2005). Multiband internal antenna for mobile phones, *Electronics Letters*, Vol. 41, No. 9, (April 2005), pp. 514-515, ISSN 0013-5194.
- Guo, Y.-X.; Luk, K.-M. & Lee, K.-F. (2002). Broadband Dual Polarization Patch Element for Cellular-Phone Base Stations, *IEEE Transactions on Antennas and Propagation*, Vol. 50, No. 2, (February 2002), pp. 251-253, ISSN 0018-926X.
- Guo, Y.-X. & Tan, H.-S. (2004). New Compact Six-Band Internal Antenna, *IEEE Antennas and Wireless Propagation Letters*, Vol. 3, (December 2004), pp. 295-297, ISSN 1536-1225.
- Guterman, J.; Moreira, A. A. & Peixerio, C. (2006). *IEEE Antennas and Wireless Propagation Letters*, Vol. 5, No.1, (December 2006), pp. 141-144, ISSN 1536-1225.
- Haapala, P.; Vainikainen, P. & Eratuuli, P. (1996). Dual Frequency Helical Antennas for Handsets, *IEEE Vehicle Technology Conference*, pp. 336-338, ISBN 0-7803-3157-5, Atlanta, GA, USA, April 28-May 1, 1996.
- Huang, Yi. & Boyle, K. (2008). *Antennas: From Theory to Practice*, John Wiley & Sons, Inc., ISBN 978-0-470-51028-5, London, UK.
- Jing, X.; Du, Z. & Gong, K. (2006). A Compact Multi-Band Planar Antenna for Mobile Handsets, *IEEE Antennas and Wireless Propagation Letters*, Vol. 5, No.1, (December 2006), pp. 343-345, ISSN 1536-1225.
- Katsibas, K. D.; Balanis, C. A., Tirkas, P. A. & Birtcher, C. R. (1998). Folded Loop Antenna for Mobile Hand-Held Units, *IEEE Transactions on Antennas and Propagation*, Vol. 46, No. 2, (February 1998), pp. 260-266, ISSN 0018-926X.
- Lan, K.; Chaudhuri, S. K. & Safavi-Naeini, S. (2003). *IEEE International Symposium on Antennas and Propagation Society*, pp. 926-929, ISBN 0-7803-7846-6, Ontario, Canada, June 22-27, 2003.
- Leach, S. M.; Agius, A. A. & Saunders, S. R. (2000). Intelligent Quadrifilar Helix Antenna, *IEE Proceedings- Microwaves, Antennas and Propagation*, Vol. 147, No. 3, (June 2000), pp. 219-223, ISSN 1350-2417.

- Lee, E.; Hall, P. S. & Gertner, P. (2000). Dual-band Folded Monopole/Loop Antenna for Terrestrial Communication Systems, *Electronics Letters*, Vol. 36, No. 23, (November 2000), pp. 1990-1991, ISSN 0013-5194.
- Lin, S.-Y. (2004). Multiband Folded Planar Monopole Antenna for Mobile Handset, *IEEE Transactions on Antennas and Propagation*, Vol. 52, No. 7, (July 2004), pp. 1790-1794, ISSN 0018-926X.
- Liu, W.-C.; Chen M.-C. & Chung, S.-J. (2004). Printed Double S-Shaped Monopole Antenna for Wideband and Multi-Band Operation of Wireless Communication, *IEE Proceedings-Microwaves, Antennas and Propagation*, Vol. 151, No. 6, (December 2004), pp. 473-476, ISSN 1350-2417.
- Mahender, P.; Natarajamani, S. & Behera, S. K. (2010). Inverted U-Shaped Dielectric Resonator Antenna for WLAN, *IEEE International Conference on Communication, Control and Computing Technologies*, pp. 9-11, ISBN 978-1-4244-7769-2, Ramanathapuram, India, October 7-9, 2010.
- Manteghi, M. & Rahmat-Samii, Y. (2006). Novel Compact Tri-band Two-element and Four-element MIMO Antenna Designs, *IEEE International Symposium on Antennas and Propagation Society*, pp. 4443-4446, ISBN 1-4244-0123-2, Albuquerque, USA, July 9-14, 2006.
- Manteuffel, D.; Bahr, A.; Heberling, D. & Wolff, I. (2001). Design Considerations for Integrated Mobile Phone Antennas, *Eleventh International Conference on Antennas and Propagation*, pp. 252-256, ISBN 0-85296-733-0, Manchester, UK, April 17-20, 2001.
- Moon, J.-I. & Park, S.-O. (2003). Small Chip Antenna for 2.4/5.8-GHz Dual ISM-Band Applications, *IEEE Antennas and Wireless Propagation Letters*, Vol. 2, No.1, (December 2003), pp. 313-315, ISSN 1536-1225.
- Rahmat-Samii, Y.; Guterman, J.; Moreira, A. A. & Peixeiro C. (2008). Integrated Antennas for Wireless Personal Communications, In: *Modern Antenna Handbook*, C. A. Balanis (ed.), 1079-1142, John Wiley & Sons, ISBN 978-0-470-03634-1, New York, USA
- Secmen, M. & Hizal, A. (2010). A Dual-Polarized Wide-Band Patch Antenna for Indoor Mobile Communication Applications, *Progress In Electromagnetics Research*, Vol. 100, (2010), pp. 189-200, ISSN 1559-8985.
- Serra A. A.; Nepa, P.; Manara, G. & Tribellini, G. & Cioci, S. (2007). A Wide-Band Dual-Polarized Stacked Patch Antenna, *IEEE Antennas and Wireless Propagation Letters*, Vol. 6, No.1, (December 2007), pp. 141-143, ISSN 1536-1225.
- Teng, P. L. & Wong, K. L. (2002). Planar monopole folded into a compact structure for very-low-profile multi-band mobile phone antenna, *Microwave and Optical Technology Letters*, Vol. 33, No. 1, (April 2002), pp. 22-25, ISSN 0895-2477.
- Wang, Y.-S.; Lee, M.-C. & Chung, S.-J. (2007). Two PIFA-Related Miniaturized Dual-Band Antennas, *IEEE Transactions on Antennas and Propagation*, Vol. 55, No. 3, (March 2007), pp. 805-811, ISSN 0018-926X.
- Wong, K.-L.; Chang, F.-S. & Chio, T.-W. (2002). Low-Cost Broadband Circularly Polarized Probe-Fed Patch Antenna for WLAN Base Station, *IEEE International Symposium on Antennas and Propagation Society*, pp. 526-529, ISBN 0-7803-7070-8, Boston, USA, June 16-21, 2002.

- Wong, K.-L.; Lee, G.-Y. & Chiou, T.-W. (2003). A Low-Profile Planar Monopole Antenna for Multi-Band Operation of Mobile Handsets, *IEEE Transactions on Antennas and Propagation*, Vol. 51, No. 1, (January 2003), pp. 121-125, ISSN 0018-926X.
- Wong, K.-L. (2003). *Planar Antennas for Wireless Communications*, John Wiley & Sons, Inc., ISBN 0-471-26611-6, New Jersey, USA.
- Wong, K.-L.; Wu, C.-H. & Su, S.-W. (2005). Ultrawide-band square planar metal-plate monopole antenna with a trident-shaped feeding strip, *IEEE Transactions on Antennas and Propagation*, Vol. 53, No. 4, (April 2005), pp. 1262-1269, ISSN 0018-926X.
- Yeo, J.; Lee, Y. J. & Mittra, R. (2004). A novel dual-band WLAN antenna for notebook platforms, *IEEE International Symposium on Antennas and Propagation Society*, pp. 1439-1442, ISBN 0-7803-8302-8, Monterey, USA, June 19-25, 2004.
- Zhang, F. G.; Wu, W.; Lei, G. & Gong, S. (2011). A Wideband Dual-Sleeve Monopole Antenna for Indoor Base Station Application, *IEEE Antennas and Wireless Propagation Letters*, Vol. 3, (January 2011), pp. 45-48, ISSN 1536-1225.

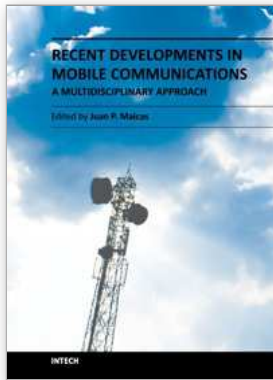

Recent Developments in Mobile Communications - A Multidisciplinary Approach

Edited by Dr Juan P. Maicas

ISBN 978-953-307-910-3

Hard cover, 272 pages

Publisher InTech

Published online 16, December, 2011

Published in print edition December, 2011

Recent Developments in Mobile Communications - A Multidisciplinary Approach offers a multidisciplinary perspective on the mobile telecommunications industry. The aim of the chapters is to offer both comprehensive and up-to-date surveys of recent developments and the state-of-the-art of various economical and technical aspects of mobile telecommunications markets. The economy-oriented section offers a variety of chapters dealing with different topics within the field. An overview is given on the effects of privatization on mobile service providers' performance; application of the LAM model to market segmentation; the details of WAC; the current state of the telecommunication market; a potential framework for the analysis of the composition of both ecosystems and value networks using tussles and control points; the return of quality investments applied to the mobile telecommunications industry; the current state in the networks effects literature. The other section of the book approaches the field from the technical side. Some of the topics dealt with are antenna parameters for mobile communication systems; emerging wireless technologies that can be employed in RVC communication; ad hoc networks in mobile communications; DoA-based Switching (DoAS); Coordinated MultiPoint transmission and reception (CoMP); conventional and unconventional CACs; and water quality dynamic monitoring systems based on web-server-embedded technology.

How to reference

In order to correctly reference this scholarly work, feel free to copy and paste the following:

Mustafa Secmen (2011). Multiband and Wideband Antennas for Mobile Communication Systems, Recent Developments in Mobile Communications - A Multidisciplinary Approach, Dr Juan P. Maicas (Ed.), ISBN: 978-953-307-910-3, InTech, Available from: <http://www.intechopen.com/books/recent-developments-in-mobile-communications-a-multidisciplinary-approach/multiband-and-wideband-antennas-for-mobile-communication-systems>

INTECH
open science | open minds

InTech Europe

University Campus STeP Ri
Slavka Krautzeka 83/A
51000 Rijeka, Croatia
Phone: +385 (51) 770 447
Fax: +385 (51) 686 166

InTech China

Unit 405, Office Block, Hotel Equatorial Shanghai
No.65, Yan An Road (West), Shanghai, 200040, China
中国上海市延安西路65号上海国际贵都大饭店办公楼405单元
Phone: +86-21-62489820
Fax: +86-21-62489821

© 2011 The Author(s). Licensee IntechOpen. This is an open access article distributed under the terms of the [Creative Commons Attribution 3.0 License](#), which permits unrestricted use, distribution, and reproduction in any medium, provided the original work is properly cited.