

Tensiometer saturation and the reliable measurement of soil suction

W. A. TAKE* and M. D. BOLTON*

Recent advances in the technology for measuring matric suction have permitted the direct measurement of gauge pore water pressures lower than -100 kPa—that is, absolute tensions. This significant accomplishment has opened up a realm of research possibilities into the nature and behaviour of unsaturated soils. However, the widespread exploitation of this technology has been limited by the lack of a commercially available tensiometer capable of measuring high suctions, and by the complex and highly experience-driven nature of the filter saturation process. Much of the research on the direct measurement of matric suction has focused on achieving the maximum attainable suction value with high-pressure-range devices and large saturation pressures. However, there are many applications in physical modelling and laboratory testing where smaller suction ranges are of interest (< 400 kPa), illustrating the need for more sensitive, lower-pressure-range devices. As a consequence of the lower pressure range of these devices, the devices cannot be subjected to the high saturation pressures described in the literature. As a result, additional investigations into the processes involved in filter saturation are required. This paper investigates the importance of high initial saturation, and presents conditions for quality-assured suction measurements.

KEYWORDS: field instrumentation; partial saturation; pore pressures; suction

Les récents progrès technologiques dans le mesurage de la succion de matrice ont permis de mesurer directement au manomètre des pressions d'eau interstitielle inférieures à 100 kPa—c'est-à-dire des tensions absolues. Cet exploit significatif a ouvert de nouvelles possibilités de recherche dans la nature et le comportement des sols non saturés. Cependant, une expansion plus large de cette technologie a été entravée par l'absence dans le commerce de tensiomètres capables de mesurer des suctions élevées, ainsi que par la nature complexe et très pragmatique du processus de saturation de filtre. Une grande partie de la recherche sur le mesurage direct de la succion de matrice a cherché à obtenir la valeur de succion maximum avec des dispositifs à gamme de haute pression et de grandes pressions de saturation. Cependant, il existe de nombreuses applications dans la modélisation physique et les essais de laboratoire où des gammes de suctions plus petites sont intéressantes (< 400 kPa), ce qui montre la nécessité d'avoir des appareils plus sensibles à gamme de pression plus basse. En raison de leur gamme de pression plus basse, ces dispositifs ne peuvent pas être soumis aux hautes pressions de saturation décrites dans les textes. En conséquence, il faudra entreprendre des recherches supplémentaires dans les processus aboutissant à la saturation de filtre. Cet exposé étudie l'importance d'une haute saturation initiale et présente les conditions pour obtenir des mesures de succion fiables.

INTRODUCTION

An understanding of the fluid pressures within the void spaces of soil is fundamental to the understanding of its elemental behaviour and the stability and performance of engineered structures built with it, within it, and on it. If all voids are saturated with compressed water, the pressure within the soil's pores can simply be measured using a device consisting of a saturated porous filter, a water reservoir, and a pressure measurement device. Pressure changes in the pore water cause flow through the porous filter into the reservoir to displace the transducer diaphragm. On reaching equilibrium, the pressure measured within the water reservoir is representative of the pressure exerted in the pores of the soil. There are many instances, however, when water is held at pressures lower than atmospheric, and even in absolute tension, in discontinuous droplets suspended between soil grains. In principle, thermodynamic equilibrium will be reached by vapour transfer between the droplets and the saturated pore pressure transducer, causing it to register the correct total suction (that is, the negative pore water pressure of the droplets relative to the pore air pressure and corrected for the osmotic potential of the droplets, if any). For soil saturated with de-ionised water, as in this paper, the terms 'negative pore water pressure' and 'suction' are

synonymous, both referring to gauge pressures relative to atmospheric.

The measurement of this suction has proved very difficult, however. Using a rigorous programme of filter saturation and high air-entry filter elements, several researchers were able to briefly measure negative pore water pressures below -100 kPa upon unloading from high pressures (e.g. Mair, 1979; Standing, 1991). Ridley (1993) went on to investigate the conditions under which a device was able to withstand negative water pressures, and advanced a technology for measuring pore suctions even up to 1500 kPa. Much of the subsequent research on the direct measurement of matric suction has focused on achieving the maximum attainable suction value with high-pressure-range devices saturated using large pressures. However, there are many applications in laboratory testing and physical modelling where smaller suction ranges are of interest (< 400 kPa), illustrating the need for more sensitive, lower-pressure-range devices. Lower range devices, however, would be damaged by the application of the high pressures associated with current saturation techniques. As a result, additional investigations into the processes involved in filter saturation are required. This paper investigates the importance of high initial saturation, and presents conditions for quality-assured suction measurements.

Manuscript received 2 May 2002; revised manuscript accepted 11 November 2002.

Discussion on this paper closes 1 September 2003, for further details see p. ii.

* Schofield Centre, Cambridge University Engineering Department.

TENSIOMETER SATURATION

Introduction

The widespread exploitation of suction measurement technology has largely been limited by the complex and highly

experience-driven nature of the filter saturation process. A high degree of variability in the effectiveness of saturation procedures has led researchers to adopt saturation rituals derived from experimental experience specific to their device and the air-entry value of their filter. Indeed, Guan & Fredlund (1997) indicated that there was a different maximum suction associated with each different saturation process and tensiometer.

The maximum measurable suction is limited by:

- (a) growth of pre-existing gas bubbles
- (b) air entry, or
- (c) nucleation of vapour bubbles or release of air trapped in surface crevices.

When any of these three mechanisms separates the fluid in the water reservoir of the tensiometer from the fluid in the pores of the soil, any further soil suction simply leads to gas expansion. A high degree of saturation of the filter avoids mechanism (a). The use of fine porous filter materials, and the inherent surface tension of water, control item (b). The third mechanism relates to the tensile strength of water, but also involves the presence of nucleation sites such as surface crevices (Harvey *et al.*, 1944).

Theoretical background

Filter element saturation can be described by Boyle's law linking the pressure and volume of a bubble, together with Henry's law of solubility. Bishop & Eldin (1950) and Lowe & Johnson (1960) have applied these laws to the analogous problem of saturating triaxial specimens through the use of an applied back pressure. Air within a filter element of initial degree of saturation, S_i , at an initial absolute pressure of P_i , will compress according to Boyle's law when pressure ΔP is applied, allowing water to enter pores once occupied by air if the volume of the porous ceramic is assumed constant. Henry's law dictates that the higher pressure will also result in additional air being dissolved into the pore water. The pressure change, ΔP , required to increase the degree of saturation of a porous element to its final saturation value, S , has been shown to be

$$\Delta P = P_i \frac{(S - S_i)(1 - H)}{1 - S(1 - H)} \quad (1)$$

where H is Henry's constant, which is approximately 0.02 ml of air per ml of water at room temperature.

The theoretical change in pressure required for full final saturation, ΔP_{100} , then becomes

$$\Delta P_{100} = 49P_i(1 - S_i) \quad (2)$$

If a dry filter element at atmospheric pressure is simply submerged and pressurised, the theoretical pressure required for full saturation would be nearly 4.9 MPa. Saturation from an initial vacuum, on the other hand, may require nothing more than recovery to atmospheric pressure. According to equation (2), the vacuum at which a dry stone would become saturated upon return to atmospheric pressure is 2 kPa absolute pressure. The work of Harvey *et al.* (1944), among others, indicates that any remaining air trapped within crevices of the water reservoir could be forced to dissolve under the application of high pressures, thus increasing the measurable suction of the system by stabilising these potential cavitation nuclei. Equation (2) has provided justification for a two-stage filter saturation: initial saturation under high vacuum followed by an application of positive pressure to approach full saturation.

Time to saturate

Equation (2) predicts that even the most unsaturated of tensiometers will become fully saturated under the application of a pressure of 5 MPa. This equation, however, does not indicate the time required for this process. The use of pressures in excess of 5 MPa (e.g. Guan & Fredlund, 1997) may reduce the time required for saturation, as shown for triaxial specimens by Black & Lee (1973). For initial degrees of saturation above 95%, they also demonstrated that the time required for full saturation drops considerably with an increase in initial saturation. Ridley (1993) also proposed that the time required for saturation under these high pressures can be reduced by cycling from high positive pressures to low negative pressures.

TENSIOMETER DEVELOPMENT

Tensiometer design

The design of the tensiometer is crucially important, as it influences its robustness, sensitivity, ease of saturation, speed of response, and the sustainability of large suction measurements. These features can perhaps be best identified by looking at the devices for measuring large suctions described in the literature. The current standard for the measurement of positive pore water pressures for laboratory testing and physical modelling is the Druck PDCR-81. This device consists of an instrumented silicon diaphragm supported on an internal glass cylinder and connected to a porous filter by a steel outer casing (Fig. 1(a)). Using a high-range version of this device fitted with a 15 bar air-entry porous ceramic filter and saturation at a pressure of 2000 kPa, Ridley (1993) was able to measure suctions as high as 1370 kPa. Although this device exhibits exceptional performance characteristics for the measurement of positive pore pressures, a lack of robustness for the measurement of high suctions means it is not ideally suited for this application. The lack of robustness is in three areas. Under large tensile pressures, the outward deflection of the diaphragm has been seen to cause a leak around the diaphragm to the vented sleeve, thereby venting the water reservoir to atmosphere (Ridley, 1993; Take, PhD thesis in preparation). Small holes in the vented sleeving of the device, although watertight under working pressures, are susceptible to water entry under the high water pressures associated with the second phase of filter saturation. Finally, experience has shown that there is considerable risk associated with both the initial sealing operation (excess epoxy bonding the diaphragm to the filter), and the subsequent extraction of a porous filter for replacement.

The design evolution of the Imperial College tensiometer has arrived at a device that consists of an integral strain-gauged diaphragm, a water reservoir of a reduced size, and a thick 15 bar air-entry porous ceramic filter (Fig. 1(b)). The incremental change from previous designs of the tensiometer was the reduction of the volume of the water reservoir to approximately 3 mm³, achieved through the provision of an integrated pressure diaphragm. This reduction in reservoir volume was motivated by the crevice model of tension breakdown (Ridley *et al.*, 1998). A smaller reservoir will have a smaller number of imperfections and be statistically less likely to suffer from unpredictable tension breakdowns. A consequence of the small reservoir volume is a relatively thick diaphragm, which reduces midspan deflections, but results in a low sensitivity of 0.7 $\mu\text{V}/\text{kPa}$, as reported by Tarantino & Mongiovi (2001).

The tensiometer developed at the University of Saskatchewan consists of a commercial pressure transducer fitted into a detachable housing containing the high air-entry ceramic filter. Assembled under water, the other half of the housing acts as a compression fitting and seals the transducer into

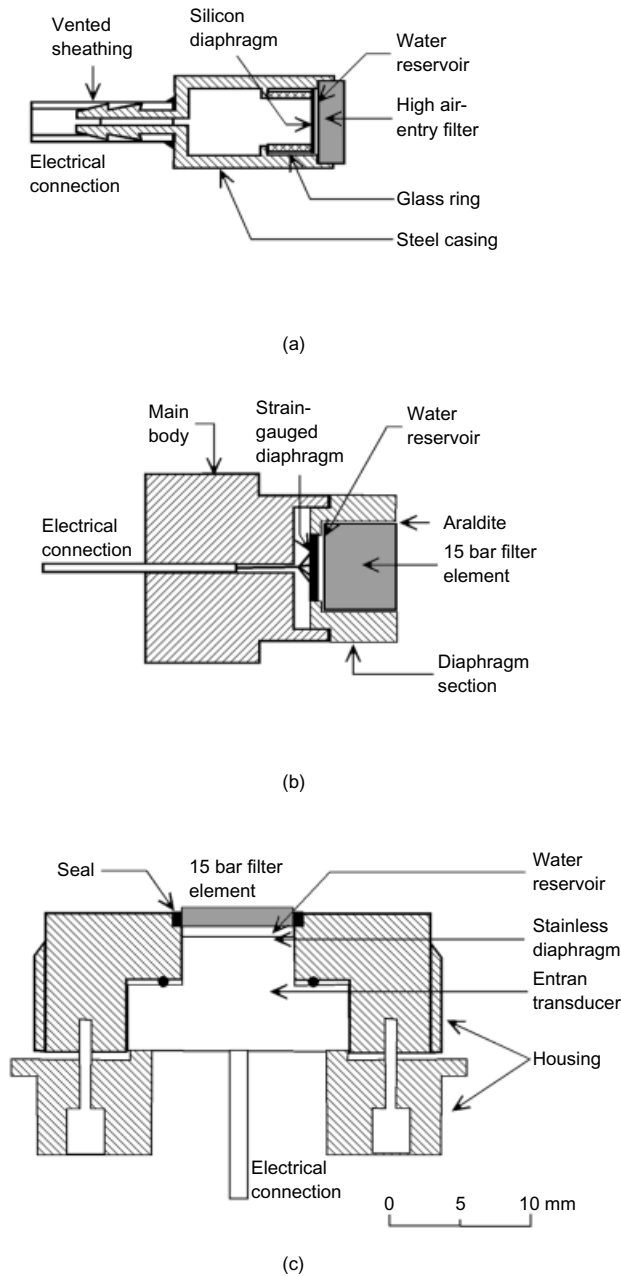

Fig. 1. Tensiometers for the measurement of high soil suction: (a) Druck PDCR-81 (after König *et al.*, 1994); (b) Imperial College tensiometer (after Ridley & Burland, 1995); (c) University of Saskatchewan tensiometer (after Guan & Fredlund, 1997)

the water reservoir (Fig. 1(c)). These researchers have observed a considerable variation in the maximum magnitude of suction at tension-breakdown using this device, which was theorised by Ridley & Burland (1999) to be a result of the imperfection-driven crevice model accompanying the large water reservoir and the potential to trap air within the complex sealing arrangement. Further, the detachable nature of the design does not restrict waterborne contaminants from entering the reservoir, as is the case in other designs. An advantage of filling the reservoir through the filter is that contaminants that may act later as cavitation nuclei can be filtered out (Ridley *et al.*, 1998).

New device

The high mortality rate of Druck PDCR-81 devices modified to measure soil suctions has prompted the development

of a new device, more robust to soil suctions in physical models. Design considerations for this device included the need for a small physical size to limit the disturbance to the model, a minimisation of the volume flow of water required to measure suctions, a diaphragm resilient against both tensile and compressive loadings, and the ability to change the filter element safely.

The initial design of the new tensiometer consisted of a 7 bar range Entran EPB stainless steel diaphragm pressure cell embedded in a brass housing. An interchangeable filter cap could then be sealed to the device, keeping the epoxy seal as far away as possible from the pressure-sensitive diaphragm (Fig. 2(a)). Although this device had the

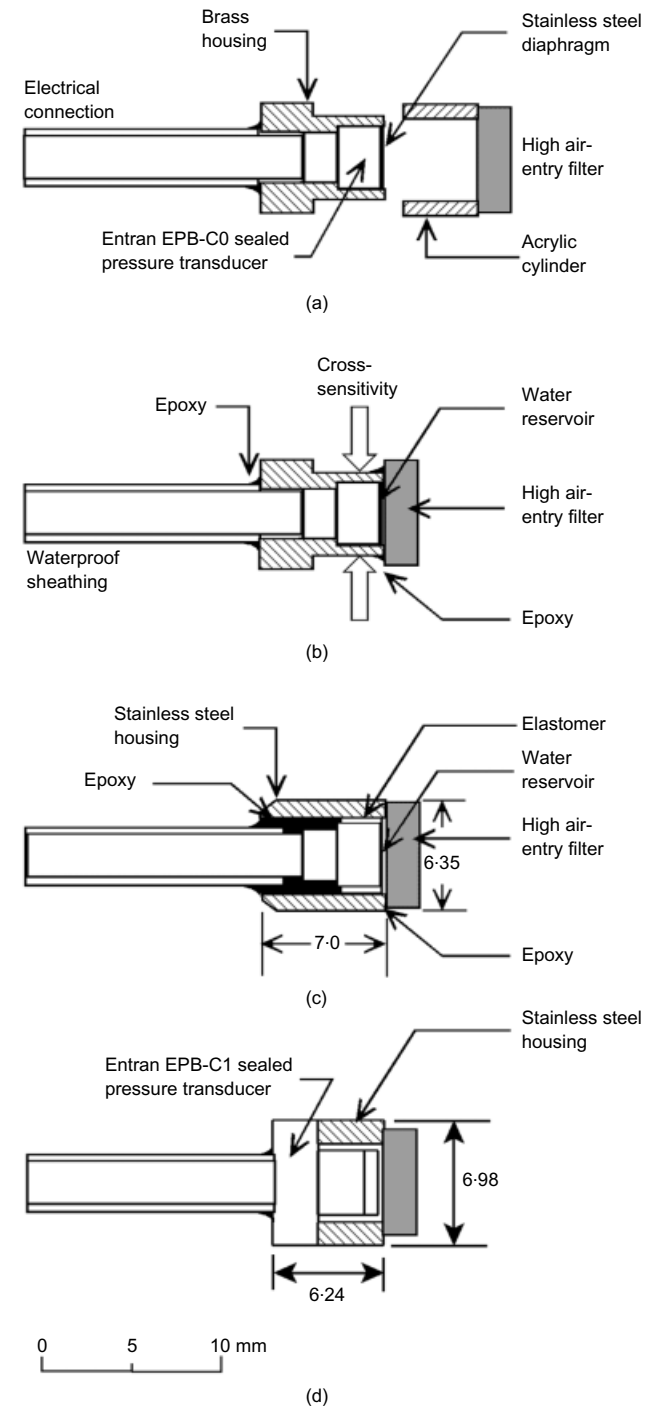

Fig. 2. Design evolution of new tensiometer: (a) filter cap; (b) direct seal; (c) isolated internal sensor; (d) prototype commercial design of a PPT (pore pressure and tension transducer)

perceived advantage of an interchangeable cap, the high water pressures associated with the saturation process tended to crack the acrylic cylinder. Once it had cracked, a shortcut path was created for air entry into the water reservoir, thereby rendering the device useless for the measurement of negative pore water pressures.

The second design, illustrated in Fig. 2(b), dispensed with the interchangeable cap concept and bonded the porous filter element directly to the end of the brass housing. Although this greatly increased the risk of accidentally bonding the diaphragm to the porous element, the stainless diaphragm proved to be resilient to this eventuality. Once fully saturated, this design resulted in successful measurements of negative water pressures below -100 kPa, but demonstrated undesirable features in deviatoric stress fields. Further investigations revealed that even small cross-axis forces on the brass, by pinching the device between the thumb and forefinger for example, are transferred to the pressure transducer, causing the diaphragm to deflect. *In situ* use of the device, therefore, would no longer measure pore pressure, but rather an unacceptable mixture of pore pressure and effective stress.

A third design was formulated in an attempt to isolate the internal pressure sensor from the stresses applied to the body of the device. This design, illustrated in Fig. 2(c), consists of a thick, rigid, stainless steel casing attached to the pressure sensor at the base of the sensor with a gap left around the sensitive face to isolate it from the casing. This gap was then infilled with an elastomer by injection, thereby eliminating a potential space where air bubbles were likely to be trapped. In addition, the presence of the elastomer in the cavity around the commercial transducer will prevent any excess sealant from the filter attachment process from creating a load transfer mechanism between the device and the outer case. Any radial deformation of the exterior shell of the device will therefore be dissipated in the elastomer, thereby successfully isolating the device from its surroundings.

In addition to the complexity of the saturation process, the lack of a commercially available tensiometer that is sufficiently robust for the measurement of suctions in excess of 100 kPa has limited the widespread adoption of the recent advances in suction measurement. A fourth tensiometer design (Fig. 2(d)) was therefore developed in collaboration with Entran Devices Inc. as a prototype commercial version of the new device. The commercial version, built by Entran on the EPB-C1 chassis, is marginally larger than version 3 (Fig. 2(c)), as it includes internal rather than external thermal compensation. Assuming that nucleation will occur at imperfections at the surfaces bounding the water reservoir rather than within the reservoir liquid, the surface area of the reservoir was reduced, rather than its volume. At the aspect ratios used for most tensiometers, the diameter of the reservoir, rather than the reservoir thickness, dominates the surface area. Thus a more sensitive device can be used to measure the pressure within a reservoir of slightly larger volume but similar surface area to the Imperial College tensiometer. Experimental evaluation of the Mark IV PPTT (pore pressure and tension transducer), however, has indicated that the reduction in surface area through the provision of an elastomer filling agent is a secondary concern to the probability of air entrapment (Take, PhD thesis in preparation). As a result, the elastomer has been dropped from the design, resulting in a slightly larger water reservoir but retaining the protection from externally applied deviatoric stresses. Ridley (1993) has reported that the sustainable duration of suction measurement is increased through the provision of a thicker filter element. The commercial version of the new tensiometer retains the thin filter element of its previous designs, reflecting the high priority given to speed of measurement.

SATURATION EXPERIMENTS

Initial saturation

Equation (2) clearly illustrates the benefit of initial filter element saturation under a high vacuum. A dedicated single-stage vacuum pump was assigned to this application, capable of a minimum absolute pressure of 0.05 kPa. An initial saturation chamber was fabricated using a 40 mm inside diameter closed-end Perspex cylinder with a compression fitting to seal the device within the chamber at one end and a vacuum line on the other. The initial saturation procedure adopted is similar to that proposed by Ridley & Burland (1999). Initially, the chamber is horizontal; the base is filled with water and allowed to de-air for one hour. The air-dry tensiometer is then inserted into the chamber, sealed and returned to a high vacuum (Fig. 3(a)). Once the tensiometer reading indicates that the device is in equilibrium with the evacuated chamber, the saturation chamber is rotated through 90° , slowly introducing water to the porous filter while under vacuum (Fig. 3(b)). After the tensiometer has been left in this state for at least 20 min, the vacuum is released and further time is allowed for saturation of the filter under atmospheric pressure.

Pre-pressurisation

The second stage of tensiometer saturation involves the application of high positive pressures to force into solution any remnants of the air phase entrained within the tensiometer. As this process involves the application of pressure before the system is used to generate tensions within the

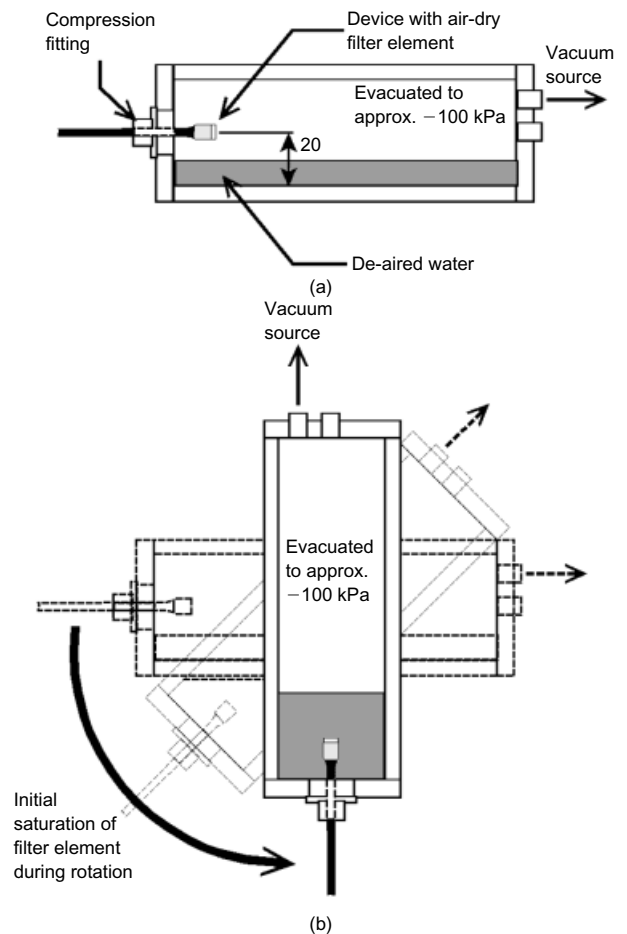

Fig. 3. Chamber for the rotational method of initial saturation of porous filter element: (a) de-airing of water and evacuation of chamber; (b) saturation

water reservoir, it has often been referred to in the literature as pre-pressurisation. The magnitude of the positive water pressure cycles is limited by the allowable over-range of the measurement diaphragm. The base device has a full-scale range of 700 kPa, with an over-range limit of 1400 kPa. To ensure that the device was not damaged in the pre-pressurisation process, positive pressure cycles were limited to a maximum pressure of 1000 kPa.

A pre-pressurisation apparatus has been fabricated consisting of a chamber for the simultaneous saturation of eight tensiometers, a pressure piston to apply the saturation pressure, and a vacuum chamber to act as a water trap (Fig. 4). Before the tensiometers are inserted into the saturation chamber, water is driven from a pressure piston into the water trap, and the system is de-aired under an absolute pressure below 1 kPa for at least 1 h. Upon the return to atmospheric pressure, the de-aired water within the water trap is drawn into the pressure piston, and the system is ready for tensiometer insertion. Pre-pressurisation cycles are then applied consisting of 1 h at 1000 kPa and 1 h below 1 kPa absolute.

Experimental methodology

Saturation experiments were conducted to validate the procedures for the initial saturation and forced dissolution phases of filter saturation. These experiments were conducted with the new tensiometer described in the preceding sections. An air-dry nominal 3 bar air-entry filter was fitted to the body of the tensiometer and initially saturated under an absolute pressure below 1 kPa absolute in the manner described in Fig. 3. The success of saturation was then assessed by allowing evaporation to occur from the filter and observing the measured tensiometer response. The relative humidity above the tensiometer filter of approximately 45% ensures an unattainable equilibrium tension of the order of 10^5 kPa, orders of magnitude higher than the air-entry value of the filter. If the tensiometer was sufficiently saturated, the suction recorded would increase until air was drawn into the system at the air-entry value of the ceramic filter.

Maximum attainable suction results

The results of the first saturation experiment are presented in Fig. 5. The tensiometer subjected only to the initial saturation procedure could not approach the air-entry value of the filter, but rather slowly descended to a value of -80 kPa. This observation appears to contradict the prediction of equation (2) that the return to atmospheric pressure should be sufficient to saturate the filter. The tensiometer response after the application of one 1000 kPa pre-pressurisation cycle similarly stalls at a value of -95 kPa. These results indicate that the initial saturation was much less than might have been anticipated. A second pre-pressurisation cycle finally increases the degree of saturation to the point where sufficient cavitation nuclei are eliminated to allow the measurement of negative pore water pressures below -100 kPa. Once the air-entry value has been exceeded, air slowly migrates into the filter until an unstable bubble forms within the chamber, and cavitation occurs. This instability is illustrated by a quick 'snap-through' to -100 kPa, which corresponds to the minimum pressure within a bubble. As shown in Fig. 5, the time required for tension breakdown varies with the following saturation cycles, but breakdown from high suction could be initiated at any time by impact loading.

The experiment was repeated with a tensiometer fitted with an air-dry 1 bar nominal air-entry value filter element. Similarly, the initial saturation of the filter proved to be insufficient to allow tensile water pressures equal to the air-entry value of the filter (Fig. 6). Pre-pressurisation immediately allows the measurement of these negative pressures.

To illustrate the importance of initial saturation on the final outcome of the saturation process, a tensiometer fitted with an air-dry nominal 3 bar air-entry filter was intentionally poorly saturated at atmospheric pressure by quickly plunging the device into a cup of water. The tensiometer was then subjected to vacuum saturation at a pressure below 1 kPa absolute in the usual method. When subjected to evaporation, the poorly saturated tensiometer slowly reduced in pressure to a value of approximately -60 kPa (Fig. 7). Four further pre-pressurisation cycles proved ineffective at producing full saturation, consistent with the applied

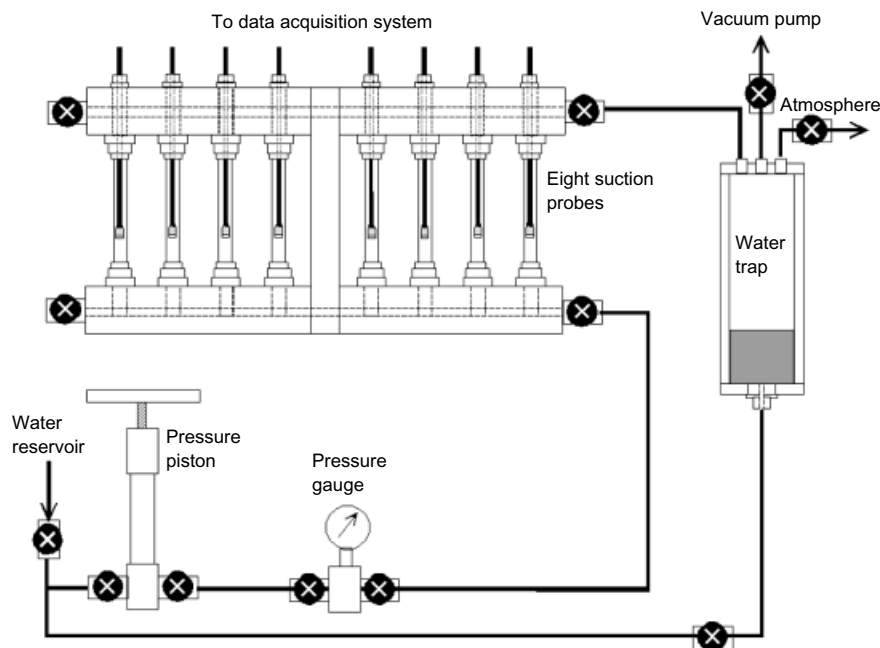

Fig. 4. Pre-pressurisation apparatus for the simultaneous saturation of eight tensiometers

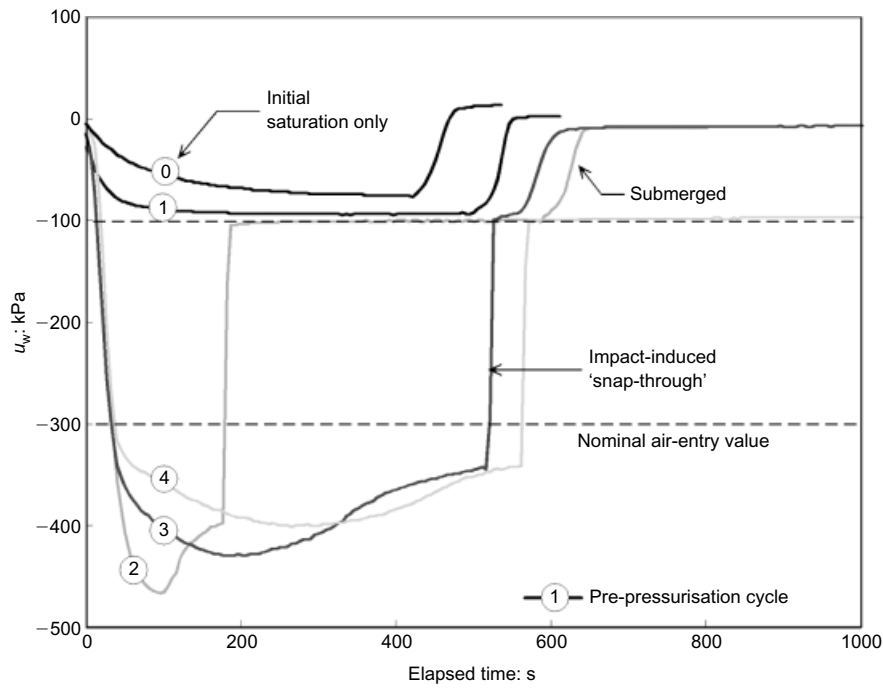

Fig. 5. Maximum measurable suction of 3 bar air-entry tensiometer with saturation effort

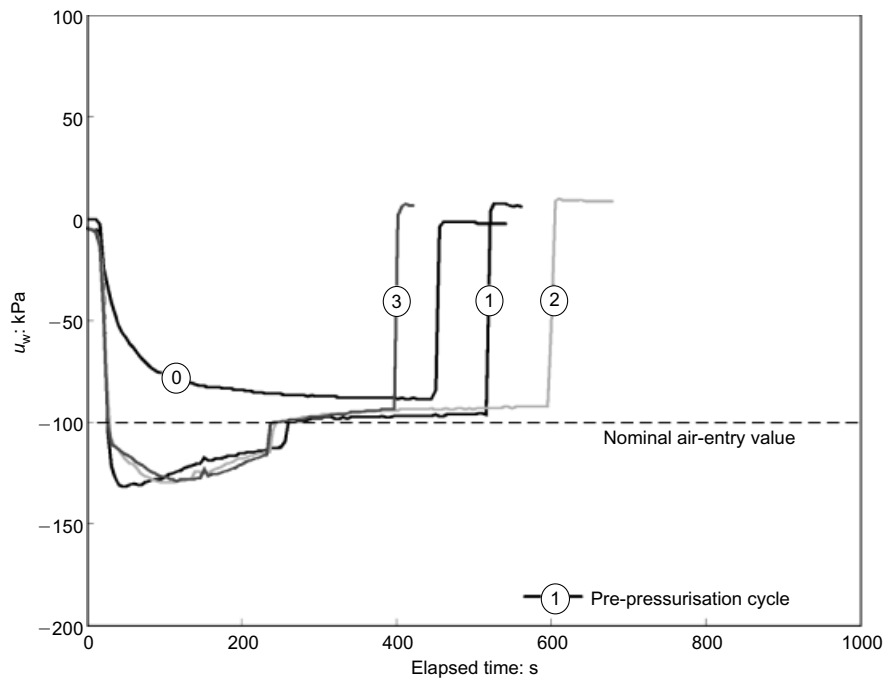

Fig. 6. Maximum measurable suction of 1 bar air-entry tensiometer with saturation effort

pressure being one-fifth of the theoretical required pressure. It must be added, however, that the additional cycles have marginally increased the ability of the device to measure larger-magnitude suctions. It is possible that with each cycle the saturation increases marginally, as not all air comes out of dissolution within the device.

RELIABLE MEASUREMENT OF MATRIC SUCTION

Initial saturation

The inability of the tensiometers to reach a high degree of saturation after initial saturation indicates that the filter

elements were not initially as dry as originally assumed (that is, $S_i > 0$), and that menisci trapped air bubbles within the filter. A theoretical basis for this explanation can be found yet again in the reported literature on triaxial sample saturation. For example, Rad & Clough (1984) include an additional term in equation (1) that requires a higher saturation pressure by accounting for surface tension effects. Water droplets have easy access to the filter element. Indeed, the porous ceramic was used air-dry and inserted by hand, a source of humid air. In addition, the tensiometers were inserted into a chamber with a free water surface at atmospheric pressure less than 10 mm away (Fig. 3(a)).

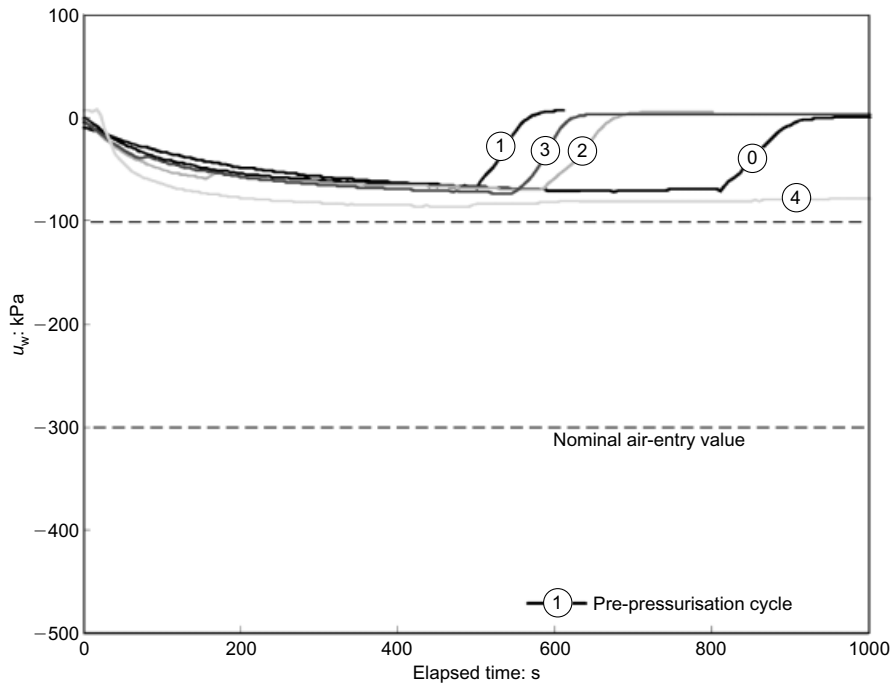

Fig. 7. Maximum measurable suction of 3 bar air-entry tensiometer initially saturated at atmospheric pressure with saturation effort

Two strategies have been employed to ensure a low initial moisture content of the ceramic filter prior to initial saturation. First, a new initial saturation chamber has been fabricated containing two separate chambers (Fig. 8). In addition, the saturation chamber and tensiometer are subjected to several hours' drying time in an oven at a temperature of 60°C. Once the water within the de-airing chamber is sufficiently de-aired, the tensiometer is inserted into the oven-dried saturation chamber. The valve to the saturation chamber is then opened, subjecting the tensiometer to an absolute pressure below 1 kPa. Finally, under the action of gravity, water is slowly introduced under vacuum as the bottom needle valve is opened. After leaving the tensiometer

in this state for at least 20 min, the vacuum is released and a further block of time is allowed for saturation of the filter under atmospheric pressure.

Experimental methodology

Additional saturation experiments were carried out to investigate the effectiveness of the new initial saturation scheme in providing a higher degree of initial saturation. Rather than assessing this effectiveness by subjecting the tensiometers to high suctions developed under an evaporative boundary condition, the behaviour of the device was carefully scrutinised within the pressure range -99.9 kPa to

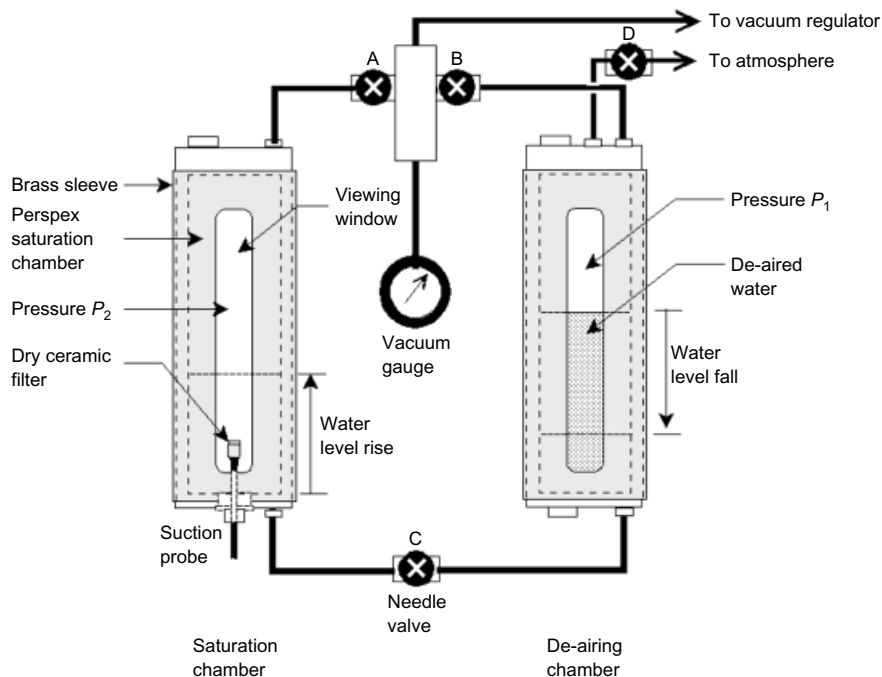

Fig. 8. Saturation chamber for dry initial saturation of tensiometer

100 kPa. Once initially saturated, tensiometers were left under water and subjected to 10 kPa pressure increments of 100 s duration descending to -99.9 kPa followed by a stepwise increase to 100 kPa before returning to atmospheric pressure. The pressure sequence was chosen so that the devices were first assessed under negative water pressures rather than under positive pressures, which would act to increase the degree of saturation of the tensiometers. The pressure within the chamber was monitored by a digital

pressure calibrator and a high-resolution pressure transducer. The stepwise pressure change regime, therefore, can be considered a rigorous calibration experiment of a tensiometer. Any deviation from the pressure observed by the reference devices will illustrate a measurement error of the tensiometer due to insufficient saturation. A comparison of the response of tensiometers of differing degrees of saturation will illustrate the variation in the magnitude of errors associated with insufficient saturation.

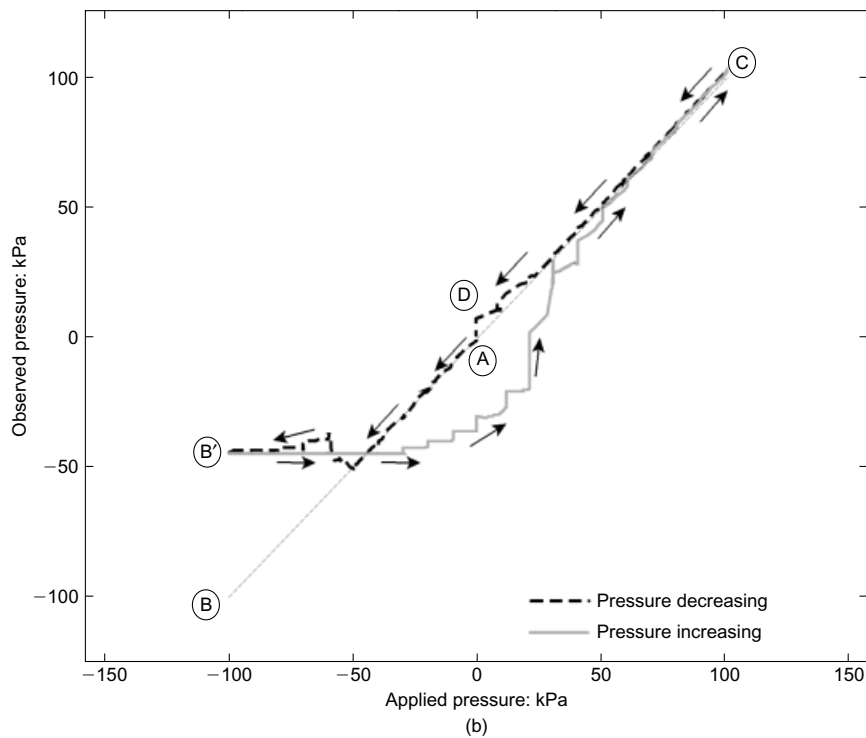
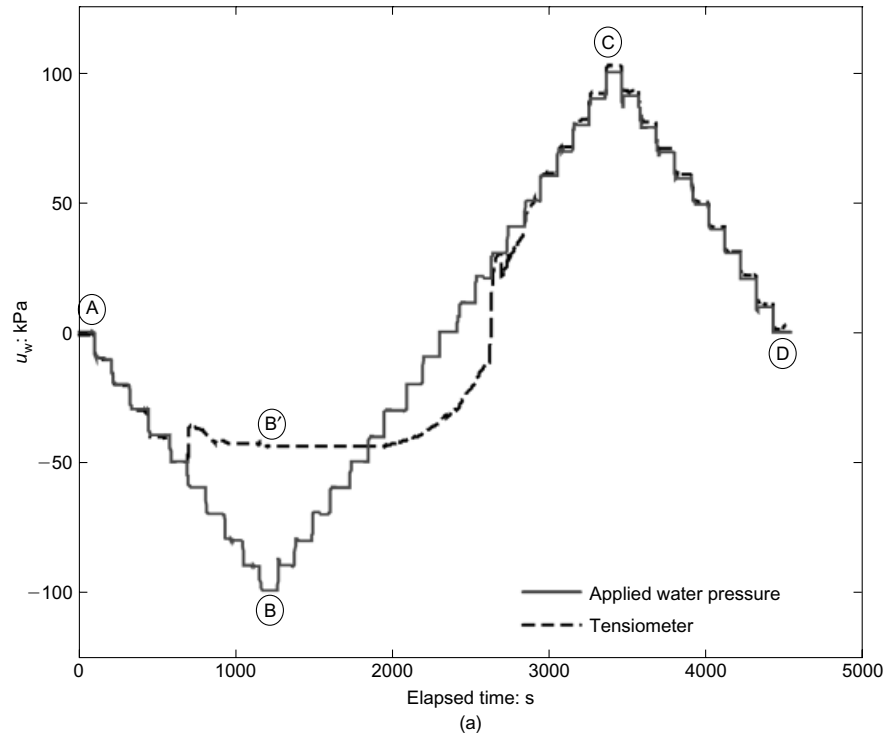

Fig. 9. Tensiometer (1 bar filter) of initial degree of saturation 0.51: (a) stepwise calibration; (b) non-linearity and hysteresis

Assuming the oven-dry condition of the tensiometers is sufficient to ensure an initial degree of saturation of zero and to allow the dismissal of surface tension effects, the initial absolute saturation pressure, P_1 , will determine the resulting degree of saturation, S , as

$$S = \frac{\Delta P}{0.98(P_1 + \Delta P)} \quad (3)$$

Tensiometers fitted with 1 bar air-entry filter elements were subjected to initial saturations at gauge pressures of

–50 kPa, –75 kPa, –95 kPa and –100 kPa, corresponding to theoretical degrees of saturation of 0.51, 0.77, 0.97 and 1.00.

Quality assurance results

The observed response of the tensiometer of saturation 0.51 to the stepwise applied pressures is presented against time in Fig. 9(a). As intuitively expected, the response of this tensiometer is poor. Initially at atmospheric pressure at

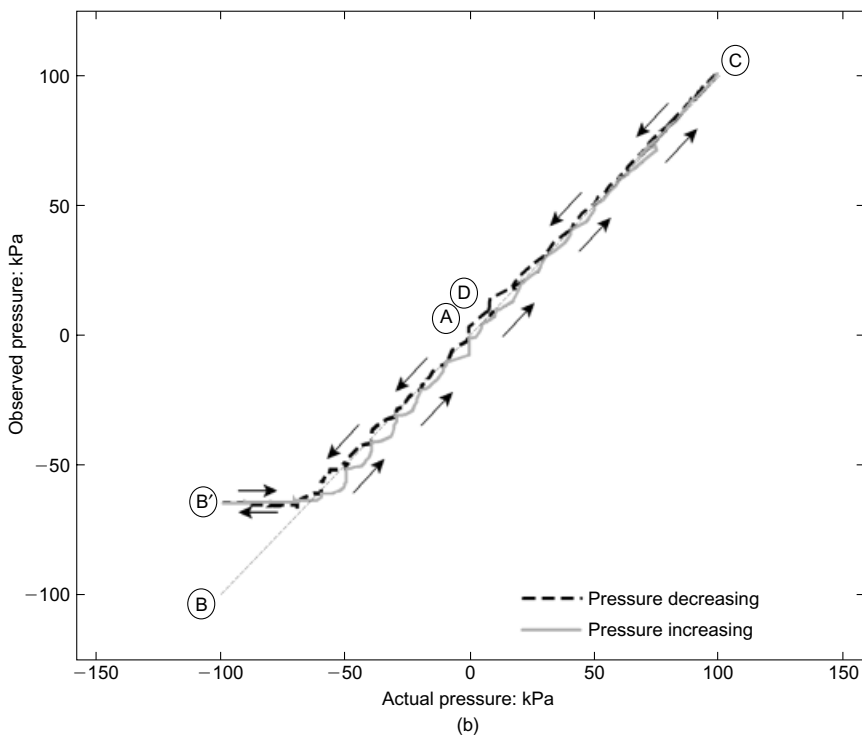
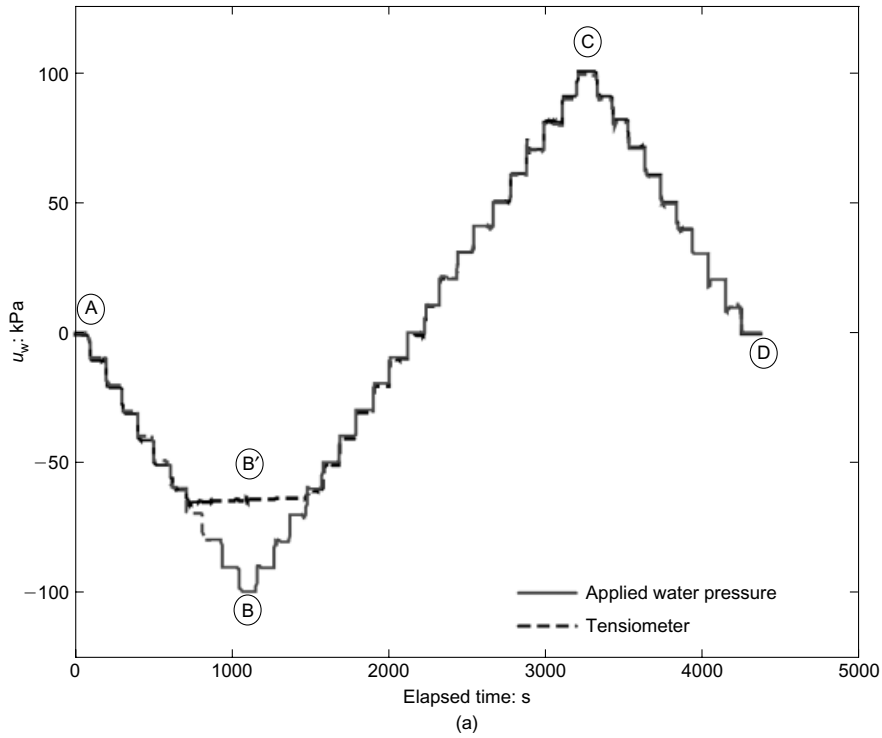

Fig. 10. Tensiometer (1 bar filter) of initial degree of saturation 0.77: (a) stepwise calibration; (b) non-linearity and hysteresis

point A, the device appears to perform well as it measures increasingly lower tensile water pressures. Upon attempts to drop the applied pressure below the initial saturation pressure of -50 kPa, the tensiometer reading becomes unstable and indicates an increase in pressure. Rather than descending to the applied pressure at point B, the device stalls at a higher pressure at B'. As the applied pressure begins to rise, the tensiometer remains oblivious to the changes in applied pressure. This is unfortunate, as it appears as if the device

has approached an 'equilibrium value'. Only after the applied pressure exceeds that within the tensiometer does the device sluggishly indicate an increase. Upon returning to atmospheric pressure, the tensiometer still indicates a pressure of -30 kPa. Further pressure increases mark the return of the tensiometer reading to reality as it approaches point C. Following the application of these positive pressures, the behaviour of the tensiometer becomes markedly more accurate as the applied pressure is reduced to zero at point D.

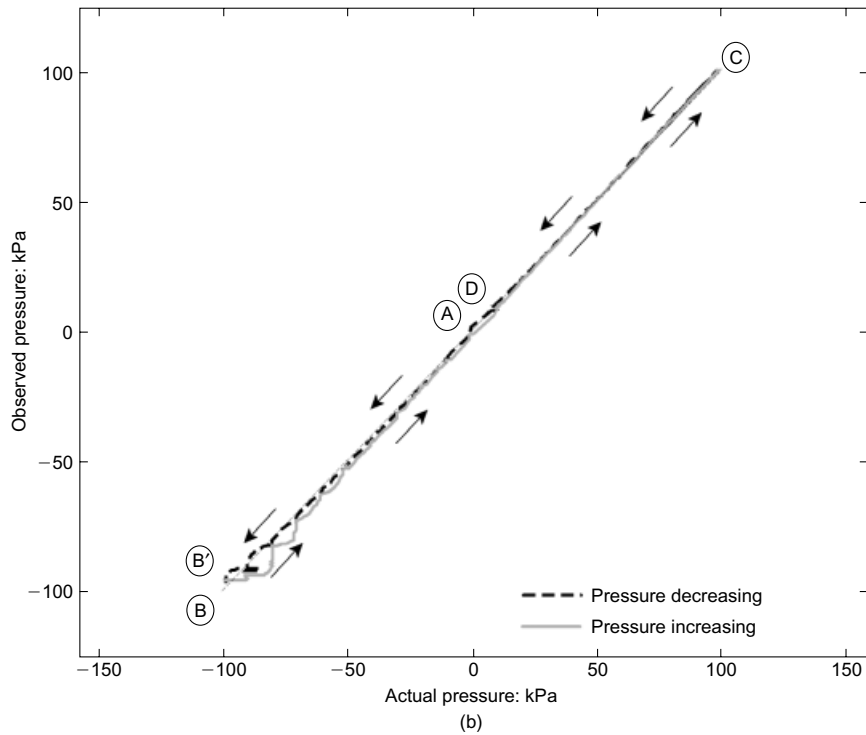
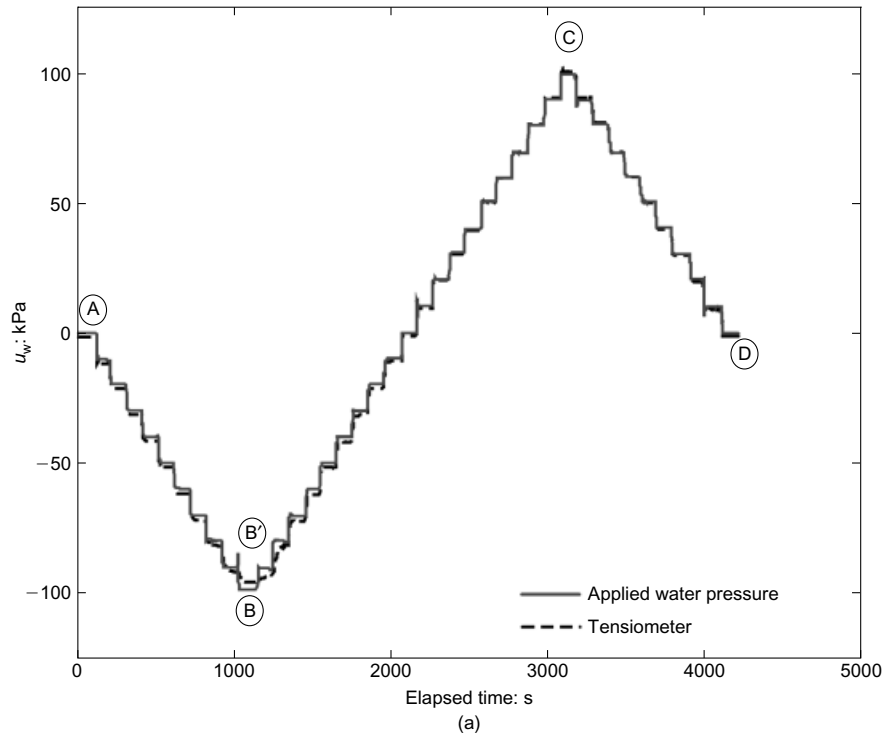

Fig. 11. Tensiometer (1 bar filter) of initial degree of saturation 0.97: (a) stepwise calibration; (b) non-linearity and hysteresis

This improvement in behaviour can be explained by the increase in the degree of saturation of the tensiometer with the higher applied pressures. If given sufficient time for saturation, equation (1) predicts that the application of 100 kPa would increase the degree of saturation of this tensiometer to 0.76.

The hysteretic behaviour of the poorly saturated tensiometer can be clearly seen by plotting the observed tensiometer reading against the applied pressure (Fig. 9(b)). It is important to note that, although the tensiometer performs

poorly during the measurement of tensile pressures, the device behaves well at high positive pressures. Quality assurance of tensiometer readings by testing the device against positive water pressures, therefore, is not a sufficient test of saturation.

Given time, the first tensiometer would have reached a degree of saturation of 0.76 upon pressurisation to 100 kPa. The observed response of a tensiometer of such a degree of saturation to the stepwise applied pressures is presented in Fig. 10(a) and 10(b) against time and applied pressure

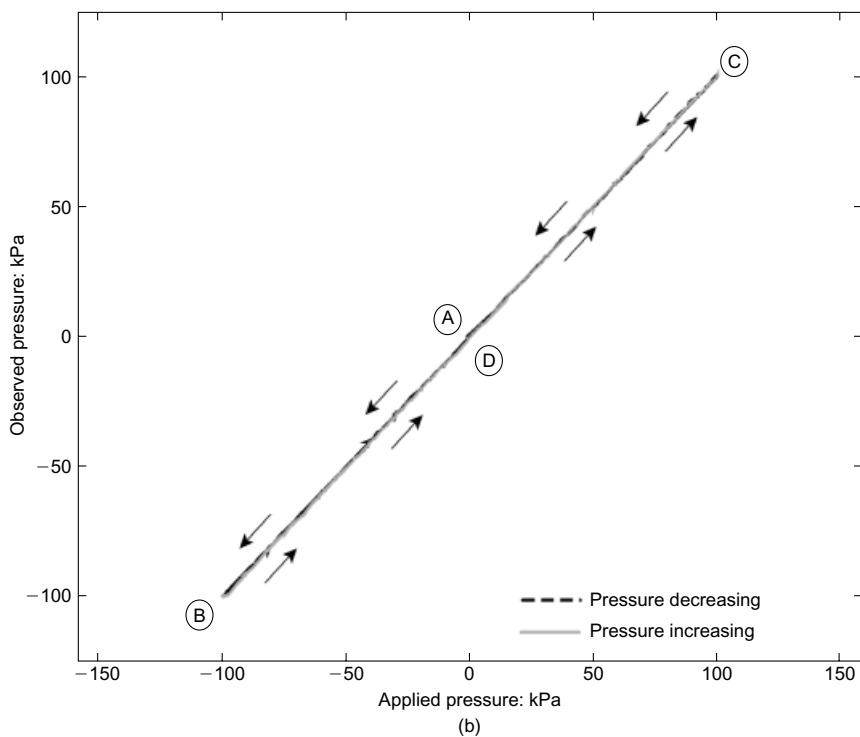
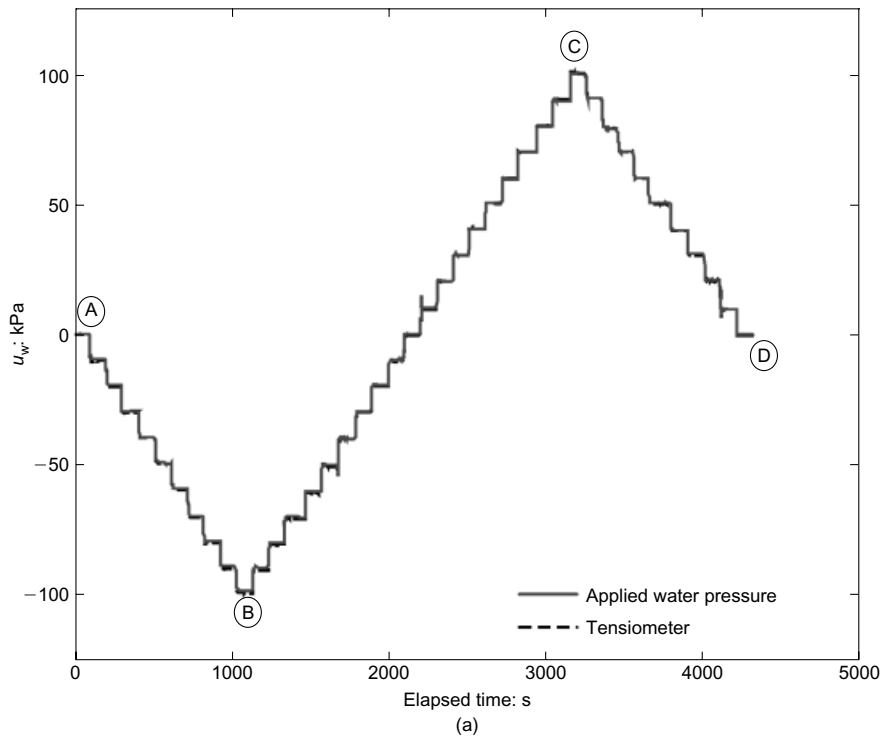

Fig. 12. Tensiometer (1 bar filter) initially saturated at an absolute pressure below 1 kPa: (a) stepwise calibration; (b) non-linearity and hysteresis

respectively. Once again, the tensiometer correctly records the correct decrease in water pressure until a maximum value is reached at which the tensiometer reading becomes erroneous. After the applied pressure is increased above the value at which the tensiometer has stalled, the tensiometer quickly regains its ability to record the correct pressure changes. The lag time of the tensiometer becomes less significant as the pressure rises, and is almost non-existent at the highest applied pressures (Fig. 10(b)). Comparison of Figs 9(b) and 10(b) illustrates that the increase in saturation

from 0.51 to 0.77 has reduced the minimum measurable water pressure, and has significantly reduced the hysteretic nature of the tensiometer calibration.

The third saturation trial was performed with a tensiometer of an initial degree of saturation of 0.97. The increase in the initial degree of saturation has greatly improved the minimum water pressure measurable by the tensiometer to -96 kPa (Fig. 11(a)). The permeability of the filter element has also shown a marked improvement. As shown in Fig. 11(b), the speed of the pressure change

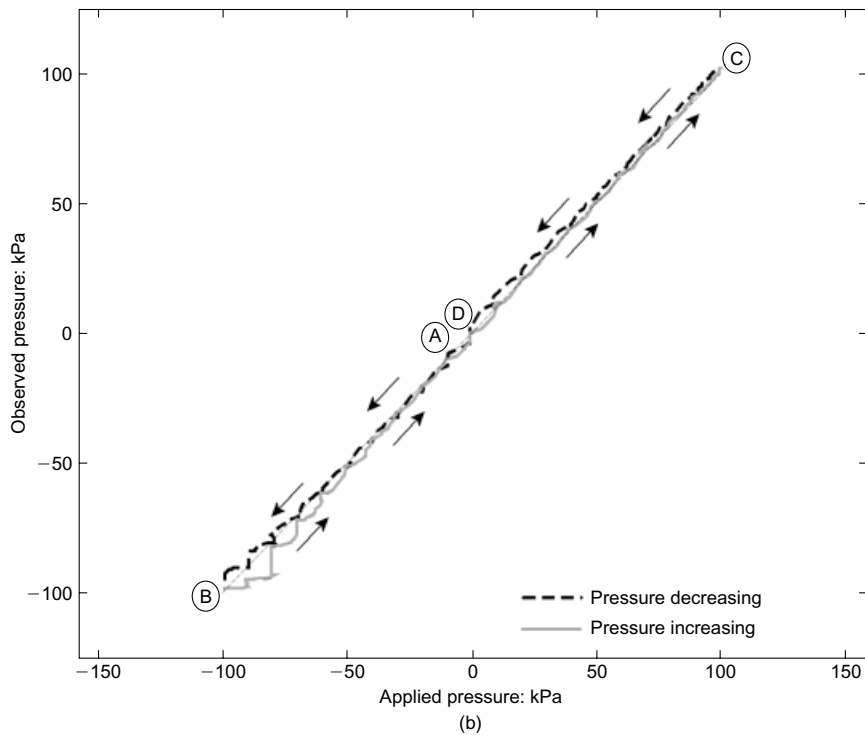
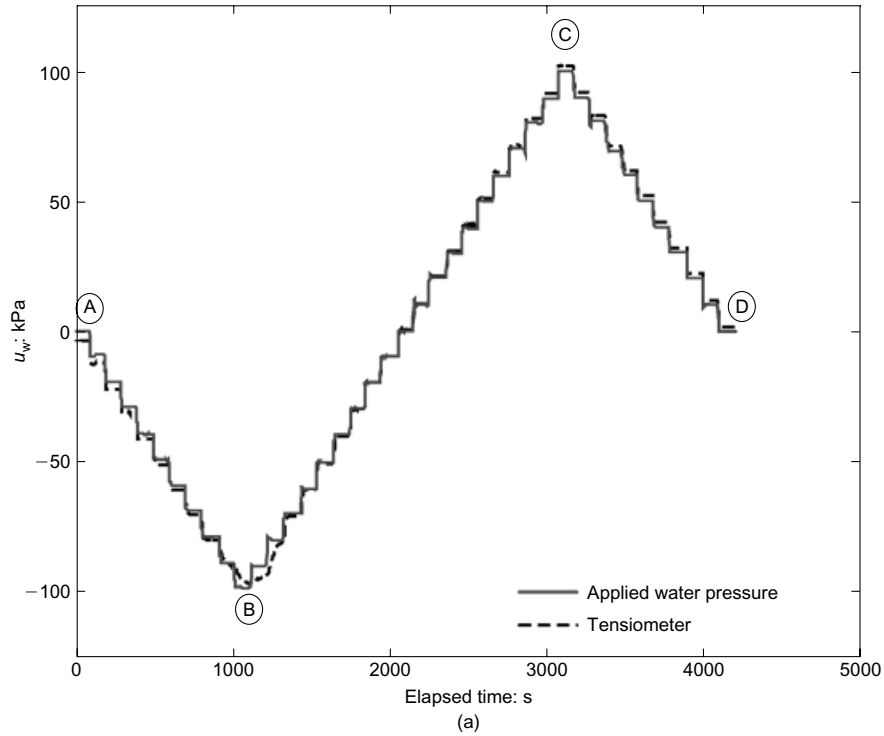

Fig. 13. Tensiometer (3 bar filter) initially saturated at an absolute pressure below 1 kPa: (a) stepwise calibration; (b) non-linearity and hysteresis

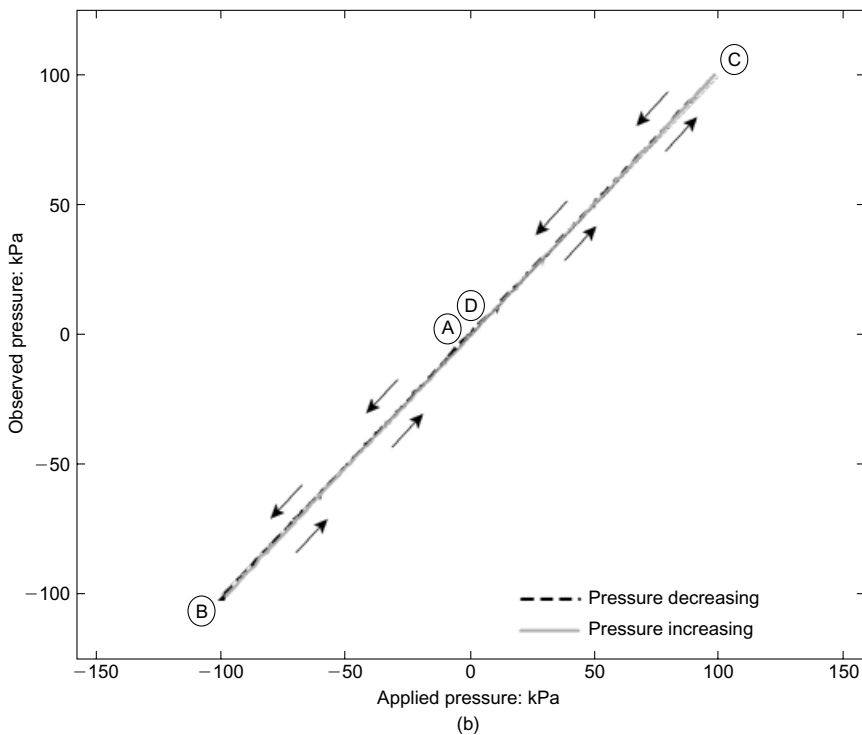
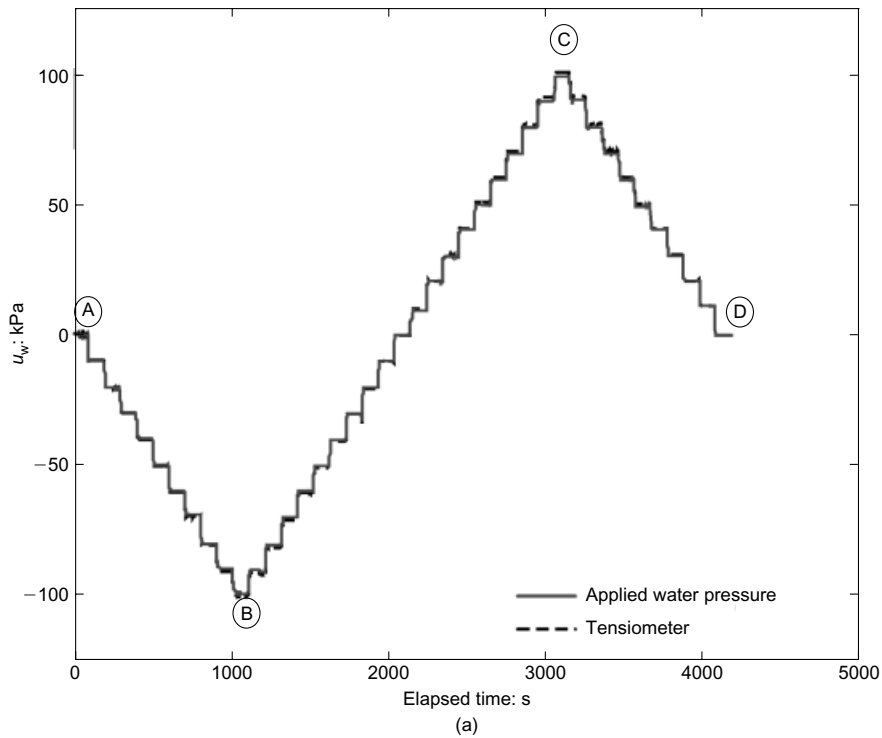

Fig. 14. Tensiometer (3 bar filter) initially saturated at an absolute pressure below 1 kPa and subjected to one pre-pressurisation cycle: (a) stepwise calibration; (b) non-linearity and hysteresis

exceeds the capacity of the tensiometer only at pressures below -50 kPa. It is important to note that, although a least-squares linear regression will yield a very low standard error, even down to the minimum calibration pressure, the device is not fully saturated. Quality assurance of tensiometer readings by testing the device against negative water pressures achieved at equilibrium, by itself, is not a sufficient test of saturation.

The theoretical basis of the initial saturation procedure

has predicted that a tensiometer saturated at pressures lower than -98 kPa should be sufficient for full saturation upon return to atmospheric pressure conditions. The fourth saturation trial used a tensiometer initially saturated at a pressure below 1 kPa absolute. The stepwise calibration process for this device yields identical results for both the tensiometer and applied pressure (Fig. 12(a)). Further, Fig. 12(b) indicates that the speed of response of the tensiometer does not experience degradation even at low water pressures. Upon

return to atmospheric pressure, water was allowed to freely evaporate from the filter element when exposed to room conditions. The tensiometer quickly dropped to a pressure of -132 kPa, corresponding to the air-entry value of the filter element. This observation is consistent with the prediction based upon the gas laws. The ability of the oven-dry tensiometer to achieve a much higher initial saturation than that of the air-dry tensiometer initially saturated over water indicates the importance of the initial moisture condition. Further, from a quality assurance perspective, the speed of response of a tensiometer subjected to negative water pressure changes appears to be an excellent indication of tensiometer saturation.

The theoretically perfect saturation was also repeated for a tensiometer fitted with a 3 bar air-entry filter element. In contrast to the repeatable success witnessed in the initial saturation of the 1 bar filter air-entry tensiometers, the higher air-entry device could not reach -99.9 kPa (Fig. 13(a)), and illustrated considerable lag time in its response to the stepwise changes in applied pressure (Fig. 13(b)). Once subjected to a pre-pressurisation cycle of 1000 kPa for 1 h, the tensiometer was sufficiently saturated to record the lowest available calibration pressure (Fig. 14(a)) without degradation in its speed of response, indicating a reduced value of permeability to water (Fig. 14(b)). Testing of the air entry of the device subsequently recorded a very quick descent to -530 kPa. Once again, the speed of tensiometer response has provided an excellent indicator of sufficient saturation.

It is possible that the 3 bar air-entry tensiometer filter increased its moisture content in the few minutes between removal from the oven and insertion into the chamber, or that it was not given sufficient time at atmospheric pressure to approach full saturation. Regardless, the initial saturation technique has still produced a tensiometer that is very highly saturated indeed. It is logical to take the instrument to the top of its pressure range to ensure maximum saturation. If the degree of initial saturation is very high, there appears to be no additional gain by providing pressure cycles to very low pressures during pre-pressurisation. The high degree of initial saturation has increased the air-entry value of the tensiometer to -530 kPa from the values shown in Fig. 5.

CONCLUSIONS

A new pore pressure and tension transducer (PPTT) has been developed for the measurement of soil suctions in excess of 100 kPa. In order to obtain more accurate suction measurements, this device has been used to investigate the saturation process of tensiometers and to develop indicators of sufficient saturation.

Boyle's law linking pressure and volume and Henry's law of solubility have provided justification for a two-stage filter saturation process: initial saturation under high vacuum followed by an application of positive pressure to stabilise potential cavitation nuclei. If the filter element is not fully dry upon initial saturation, surface tension effects have been observed to increase the pressure required to saturate the filter.

The importance of initial saturation for the observed final saturation outcome has prompted the development of a new initial saturation process. For high saturation, filters must first be oven-dried and placed quickly in a vessel containing dry air, and then subjected to very low absolute pressures (< 1 kPa). Water under vacuum can then be introduced from a second chamber prior to the vacuum being released. This procedure alone, without any subsequent over-pressure being

applied, was sufficient to saturate a 1 bar air-entry porous stone to achieve reliable suction measurements. A finer 3 bar air-entry filter was more difficult to saturate, and required an additional single over-pressure cycle to achieve an ideal response.

A very high degree of saturation of the transducer filter is required if reliable suctions are to be measured. Poor saturation not only limits the measurable suction but also introduces pressure hysteresis, which can create errors even in positive pore pressure measurements, and give poor response times. Quality assurance of tensiometer readings by testing the device against positive, or even negative, water pressures achieved at equilibrium has been observed to be an insufficient test of saturation. Tensiometer response times, especially under low absolute pressures, however, are an excellent indicator of tensiometer saturation.

ACKNOWLEDGEMENTS

The authors would like to thank the Chief Technician at the Schofield Centre, Chris Collison, for his expert technical assistance and tireless efforts during the development of the new tensiometer and saturation equipment. The first author would like to gratefully acknowledge the financial support of the Commonwealth Scholarship Scheme.

REFERENCES

- Bishop, A. W. & Eldin, G. (1950). Undrained triaxial tests on saturated sands and their significance in the general theory of shear strength. *Géotechnique* **2**, No. 1, 13–32.
- Black, D. K. & Lee, K. L. (1973). Saturating laboratory samples by back-pressure. *J. Geotech. Engng Div., ASCE* **99**, No. 1, 75–93.
- Guan, Y. & Fredlund, D. G. (1997). Use of the tensile strength of water for the direct measurement of high soil suction. *Can. Geotech. J.* **34**, 604–614.
- Harvey, E. N., Barnes, D. K., McElroy, A. H., Whiteley, A. H., Pease, D. C. & Cooper, K. W. (1944). Bubble formation in animals, 1. Physical factors. *J. Cell. Comp. Physiol.* **24**, No. 1, 1–22.
- König, D., Jessberger, H. L., Bolton, M. D., Phillips, R., Bagge, G., Renzi, R. & Garnier, J. (1994). Pore pressure measurement during centrifuge model tests: experience of five laboratories. *Proceedings of Centrifuge '94* (eds Leung, Lee and Tan), pp. 101–108. Rotterdam: Balkema.
- Lowe, J. & Johnson, T. C. (1960). Use of back-pressure to increase degree of saturation of triaxial test specimens. *Proceedings of ASCE research conference on shear strength of cohesive soils*, Boulder, pp. 819–836.
- Mair, R. J. (1979). *Centrifugal modelling of tunnel construction in soft clay*. PhD dissertation, Cambridge University, UK.
- Rad, N. S. & Clough, G. W. (1984). New procedure for saturating sand specimens. *ASCE J. Geotech. Engng*, **110**, No. 9, 1205–1218.
- Ridley, A. M. (1993). *The measurement of soil moisture suction*. PhD dissertation, Imperial College, University of London.
- Ridley, A. M. & Burland, J. B. (1995). A pore pressure probe for the in situ measurement of soil suction. *Proceedings of conference on advances in site investigation practice*, London.
- Ridley, A. M. & Burland, J. B. (1999). Use of the tensile strength of water for the direct measurement of high soil suction: discussion. *Can. Geotech. J.* **36**, 178–180.
- Ridley, A. M., Patel, A. R. & Marsland, F. (1998). Tensiometers: their design and use for civil engineering purposes. In *Geotechnical site characterisation*, pp. 851–856. Rotterdam: Balkema.
- Standing, J. (1991). Personal communication cited in Ridley (1993).
- Tarantino, A. & Mongiovì, L. (2001). Experimental procedures and cavitation mechanisms in tensiometer measurements. *Geotech. Geol. Engng* **19**, 189–210.