

Adaptive Inverse Control based on Linear and Nonlinear Adaptive Filtering

Bernard Widrow and Gregory L. Plett

Department of Electrical Engineering,
Stanford University, Stanford, CA 94305-9510

Abstract

At present, the control of a dynamic system (the “plant”) is generally done by means of feedback. This paper proposes an alternative approach that uses adaptive filtering to achieve feedforward control for both linear and nonlinear plants. Precision is attained because of the feedback incorporated in the adaptive filtering. Disturbance in the plant can be optimally controlled by a special circuit that obtains the disturbance at the plant output, filters it, and feeds it back into the plant input. The circuit works in such a way that the feedback does not alter the plant dynamic response. The concept of adaptive inverse control has application to both linear and nonlinear, MIMO and SISO plants [1].

Keywords: adaptive control, adaptive inverse control, MIMO control, SISO control, nonlinear control, linear control

1: Introduction

In classical analog control systems, feedback is used to attain precise control of the plant [2]. Likewise, discrete time control systems build on this classical material and use similar methods to control a plant using a digital computer [3]. However, we propose that those methods which are most natural for developing an analog controller are not the most natural for developing a digital controller.

Here, we present a different control paradigm for discrete-time control which uses adaptive signal processing methods to control either linear or nonlinear, SISO or MIMO plants. Precision is attained, not due to output feedback, but rather due to the implicit feedback incorporated in the adaptive process.

The control of plant dynamic response is treated separately, without compromise, from the optimal control of plant disturbance. All of the required operations are based on adaptive filtering techniques. Following the proposed methodology, knowledge of adaptive signal processing allows one to go deeply into the field of adaptive control.

In this paper, we first discuss the adaptive elements used by the adaptive inverse control designer. Next, the adaptive inverse control concept is presented; an example and conclusions follow.

2: Adaptive elements

The basis for adaptive inverse control rests firmly on the foundational theory of adaptive signal processing. Depending on the particular control problem at hand, either or both of the two basic categories of adaptive element may be required, that is, linear adaptive elements (filters) or nonlinear adaptive elements. These are described in the following sections.

2.1: Linear adaptive elements

A linear single-input single-output (SISO) filter of length n is depicted in Fig. 1. It consists of a tapped-delay line, a set of weights (w_0, w_1, \dots, w_n) and a summation unit. The output of the filter is computed as the weighted sum of the past $n + 1$ input samples. The filter shown is an FIR (finite impulse response) filter, which is sufficient for our purposes. IIR (infinite impulse response) filters also exist but are more difficult to adapt, and the added generality is rarely useful since an appropriately long FIR filter can approximate any IIR filter.

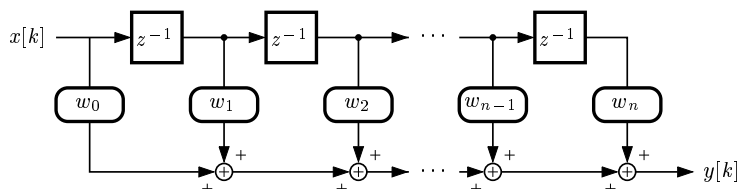

Figure 1: Structure of a linear, single-input single-output, FIR filter.

As described so far, the filter is static. Even so, it can still be useful for many purposes. Such a filter will have a fixed transfer function, that is, a fixed input-output relationship. It would be adequate for the purpose of controlling a linear plant *if we knew exactly what the transfer function of the filter needed to be*. Such information is unknown initially in a practical control problem, although it can be determined with some effort. We are therefore motivated to find an automated method of determining the required filter.

By augmenting the filter of Fig. 1 with a *desired output* and an *adaptation algorithm*, the difference between the actual output and desired output (the error) can be used by the adaptation algorithm to adapt the filter’s transfer function. In time, it will converge to the desired transfer function. One simple yet highly powerful algorithm for this task is the LMS algorithm which is discussed in reference [4].

While the filter shown in Fig. 1 is a SISO filter, it is easily modified to make an adaptive multi-input multi-output (MIMO) linear filter. Using a filter with “appropriately large” n , any linear SISO or MIMO function can be modeled.

2.2: Nonlinear adaptive elements

A nonlinear element analogous to the one shown in Fig. 1 exists; the only change is the addition of a nonlinear “sigmoid” function at the output of the device. The hyperbolic tangent function is very frequently employed for this purpose.

By itself, such a nonlinear adaptive element is rarely useful, but when combined into networks, they form a very powerful computing methodology*. Figure 2 shows a schematic representation of such a network, where the dark disks represent input values, and the white disks represent nonlinear adaptive elements as described above. The adaptive element on the right is considered to be the output of the network. Such a network has been proven to be capable of approximating (with arbitrarily small error) any smooth nonlinear function, using only two layers of adaptive elements [5]. In our work, the final layer of adaptive elements in a network have the nonlinearity removed. This allows for non-restricted dynamic range.

*often called (artificial) neural networks, where the adaptive elements are called (artificial) neurons.

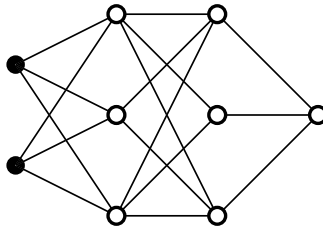

Figure 2: Schematic representation of a network of nonlinear adaptive elements.

A number of adaptation algorithms exist for these networks, but by far the most ubiquitous is the *backpropagation* algorithm. An excellent discussion of this algorithm may be found in reference [6]. Again, MIMO nonlinear filters are easily obtained by appropriate extensions.

3: The adaptive inverse control concept

3.1: Control of linear SISO plants

By constructing an appropriate topology of adaptive elements, precise control of a dynamical system can be achieved. We will first describe the adaptive inverse control concept as it applies to a linear SISO plant, and then extend the analysis to more general plants in later sections. Necessarily, we consider the plant to be stable. If it is unstable, it must first be stabilized by standard feedback techniques. The feedback need not be optimized, since any feedback that stabilizes will suffice. We also consider the plant to be time invariant (or at worst, slowly time varying with respect to the control rate). Then, a transfer function exists for the plant and is computed as the z -transform of the plant's impulse response. Similarly, there exists an inverse of this transfer function and the cascade of a filter implementing the inverse transfer function with the plant will produce the identity function—the output of the plant will exactly track the input control signal.

Clearly, this is very nearly what we would like for any regulator or tracking control problem. More generally, we might like the controlled system to have a transfer function conforming to some pre-determined model. Then, by preceding the plant by a filter whose transfer function is the product of the transfer function of the model and the inverse of the plant, a controller is implemented which gives the desired input-output relationship.

We can realize this model-reference control system by recalling that linear SISO systems commute, and constructing a system as shown in Fig. 3.

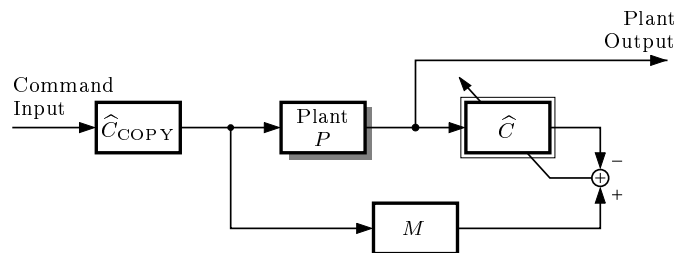

Figure 3: Adaptive inverse control structure for controlling a linear SISO plant.

In this figure, the plant is preceded by a linear filter \hat{C}_{COPY} , whose weights are copied from the adaptive filter \hat{C} . The output of \hat{C}_{COPY} is used as the input to the plant, and also as input to the linear filter M whose transfer function is that of the desired model. The output of M is then the desired output of the filter \hat{C} , and is used by the LMS algorithm to adapt \hat{C} . Thus, when adaptation has converged, the cascade of the plant followed by \hat{C} will have a transfer function equal

to the transfer function of M . Due to the commutability of linear filters, the cascade of \hat{C}_{COPY} followed by the plant will have the same desired transfer function. This is the beauty of adaptive inverse control!

One detail which has been glossed over thus far is that if the plant is nonminimum phase, then its inverse will be non-causal. In such a case, a delayed inverse can still be obtained. This is done by incorporating a pure delay term Δ into the filter M . This delay is not a deficiency of the adaptive inverse control method; indeed, it is inevitable with any controller for such a plant.

3.2: Control of linear MIMO and nonlinear plants

One property on which we relied to create the above model-reference controller was that linear SISO systems commute. Regretfully, this property does not hold for either linear MIMO or nonlinear plants. Happily, all is not lost since inverses and delayed inverses *do* commute, even for these systems. Thus, by partitioning the problem into two distinct parts, the inverse part and the model-reference part, we can in the same way come up with a controller which will control linear MIMO and nonlinear systems.

Such a controller, less the model M , is shown in Fig. 4. It is the same as the one of Fig. 3 except that the pure inverse or delayed inverse is being computed as \hat{C} . The Δ block represents a general modeling delay term necessary for a nonminimum phase plant. Additionally, the entire system would be preceded by M to give the overall desired transfer function.

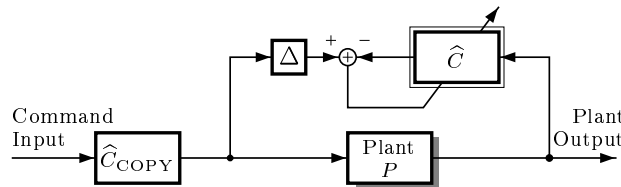

Figure 4: Inverse controller capable of linear and nonlinear, SISO and MIMO control.

One additional problem arises for nonlinear systems which has yet to be formally resolved. This is that nonlinear systems in general are not one-to-one functions, and thus do not have inverses in the strictest sense. Consider, for example, the sinusoid function which is “invertible” only in regions $[k\pi - \pi/2, k\pi + \pi/2]$, where k is an integer. That is, if $y = \sin x$, then x can only be uniquely determined if k is also known: $x = \sin^{-1}(y, k)$.

To solve this problem, we can consider nonlinear functions to have “local inverses,” and require extra side-information such as some appropriate state approximation to create a true inverse. For any nonlinear control problem, this appropriate side information will need to be determined and used to train the inverse controller.

3.3: Removing controller bias due to disturbance

When disturbance is present in the plant or in the sensing apparatus, the above method will produce a biased controller. We see this by observing that the disturbance will cause a *region* in the input space around a desired set point to be trained to have a single output value. The modified scheme in Fig. 5 alleviates this problem. For simplicity, the model has been eliminated from this figure, but it could be easily added. The bias due to disturbance is removed by first making an adaptive model of the plant, and secondly finding the inverse of the plant model. No bias exists

in the plant model since it is not the input but the output of the model which is perturbed; consequently, there will be no bias in the plant inverse.

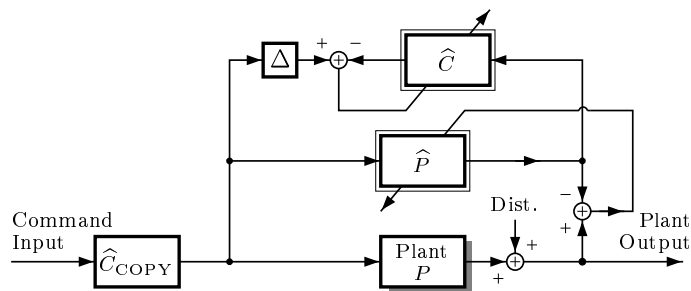

Figure 5: A system which is unbiased by disturbance.

4: Disturbance canceling

The systems presented so far allow for very simple yet effective design of controllers. However, one issue which needs to be addressed further before a fully practical controller exists is that of disturbance. We have seen that a controller can be built which is not *biased* by disturbance, but have not considered any way of rejecting the disturbance.

Classical control methods address disturbance via feedback. Using either output feedback or state feedback, the transfer function of the plant is changed to make the system stable, change the transfer function of the system in order to meet design criteria, and to provide a degree of disturbance rejection. A problem with this method is that all three of the design goals can compete with each other, and a tradeoff between them must be sought.

The adaptive inverse control concept allows the designer to address these three issues separately and independently. Feedback is still used in order to stabilize the plant, but the design of the feedback is not critical so long as the plant is stable. Secondly, we have already seen that a model-reference inverse controller is realized in order to meet the specific design requirements (i.e., those of the model). All that remains is to control the disturbance.

Rather than using feedback disturbance rejection, as is done in feedback control, adaptive inverse control uses signal processing techniques to attempt to cancel the disturbance completely. The basic idea is that the plant disturbance is estimated, filtered by a filter \hat{Q} , and then added to the plant control signal[†]. While it is beyond the scope of this paper to develop all the details of the disturbance canceler here, the interested reader is referred to reference [1] where the subject is treated comprehensively. Figure 6 shows the complete controller architecture, including disturbance canceler, for a linear SISO plant. Similar structures are used for MIMO and nonlinear plants.

5: An illustrative example

An example is used to illustrate the concepts presented in this paper. For this example, we desire to control an unstable and nonminimum-phase linear SISO plant, with transfer function:

$$\frac{(s - 0.5)}{(s + 1)(s - 1)}$$

[†]In a sense, this is feedback control, but notice that if there is no disturbance present, the feedback will be zero, and the transfer function of the plant is unaltered.

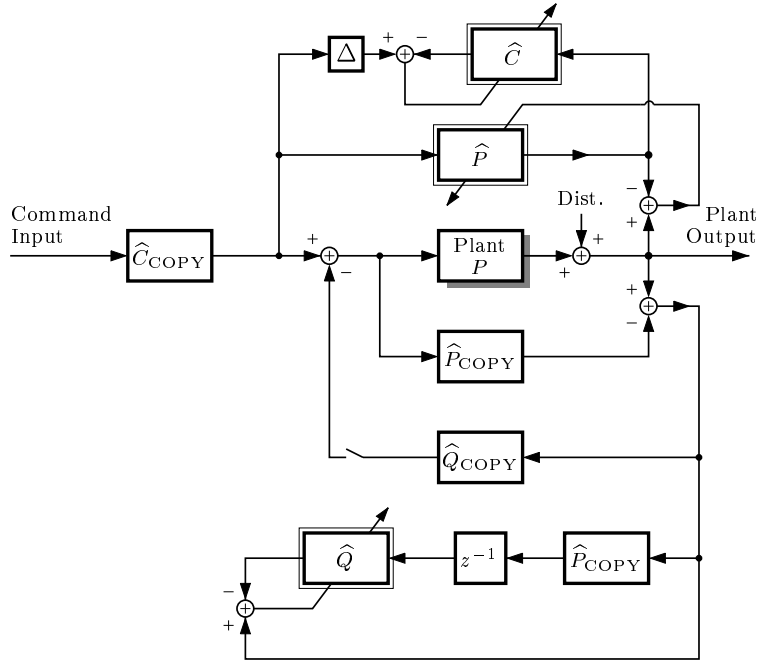

Figure 6: Complete controller including disturbance canceler, for a linear SISO plant.

The plant was stabilized by using unity feedback and a compensating network with transfer function:

$$\frac{k(s+1)}{(s+7)(s-2)}.$$

For this experiment, k was selected to be 24. The sampling rate was chosen to be 10 Hz, which gives the resulting discrete-time transfer function:

$$\frac{0.1032(z-1.0513)(z+0.8608)}{(z-0.9048)^2(z-0.8187)}.$$

The impulse response for this plant is shown in Fig. 7(a).

An adaptive inverse controller of the form shown in Fig. 3 was used, with the model M equal to a pure delay of 20 time samples. The delayed-inverse impulse response, as found by simulation, is shown in Fig. 7(b). Convolution of the plant impulse response with the delayed-inverse impulse response, we get the impulse response in Fig. 7(c). While this impulse response is not perfect, the controller is still able to accurately control the plant.

The plant was also simulated with disturbance. Figure 7(d) shows the square of the output error for a the simulated plant. The disturbance canceler was turned on at the 5,000th sample time. Dramatic improvement can be seen.

6: Conclusions

Adaptive inverse control is a very simple yet highly effective way of controlling linear or nonlinear, SISO or MIMO plants using signal processing techniques. The control scheme is partitioned into smaller sub-problems which can be independently optimized. While a simple linear example was presented, these control structures, coupled with simple learning algorithms, show great promise for the control of complicated and highly nonlinear systems. Future work needs to be done to characterize system responses and to establish the optimality of disturbance control. This is very much an open area for research.

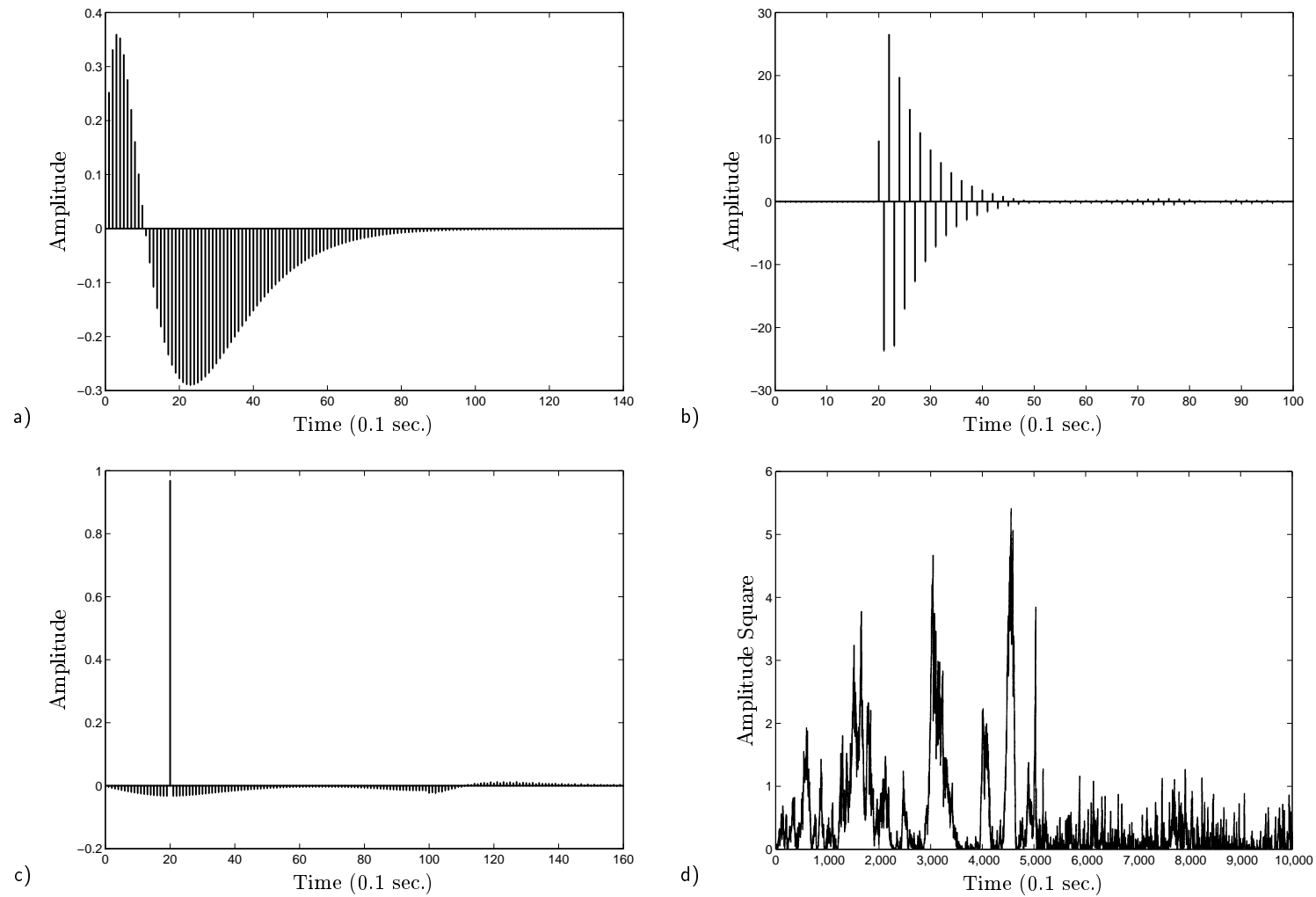

Figure 7: a) Impulse response of discretized stabilized nonminimum-phase plant; b) delayed inverse; c) convolution of plant impulse response with delayed-inverse impulse response; d) square of the output error, where disturbance cancelling began at the 5,000th sample time.

7: References

1. Bernard Widrow and Eugene Walach. *Adaptive Inverse Control*. Prentice-Hall, Englewood Cliffs, NJ, 1995.
2. Gene F. Franklin, J. David Powell, and Abbas Emami-Naeini. *Feedback Control of Dynamic Systems*. Addison-Wesley, Reading, MA, second edition, 1991.
3. Gene F. Franklin, J. David Powell, and Michael L. Workman. *Digital Control of Dynamic Systems*. Addison-Wesley, Reading, MA, second edition, 1990.
4. Bernard Widrow and Samuel D. Stearns. *Adaptive Signal Processing*. Prentice-Hall, Englewood Cliffs, NJ, 1985.
5. A. N. Kolmogorov. On the representation of continuous functions of many variables by superposition of continuous functions of one variable and addition [in Russian]. *Dokl. Akad. Nauk USSR*, 114:953–956, 1957.
6. D. E. Rumelhart, G. E. Hinton, and R. J. Williams. Learning internal representations by error propagation. In D. E. Rumelhart and J. L. McClelland, editors, *Parallel Distributed Processing*, volume 1, chapter 8. The MIT Press, Cambridge, MA, 1986.