

Spring 2014

Polymorphic Data Modeling

Steven R. Benson
Georgia Southern University

Follow this and additional works at: <http://digitalcommons.georgiasouthern.edu/etd>

 Part of the [Databases and Information Systems Commons](#)

Recommended Citation

Benson, Steven R., "Polymorphic Data Modeling" (2014). *Electronic Theses & Dissertations*. Paper 1126.

This thesis (open access) is brought to you for free and open access by the Jack N. Averitt College of Graduate Studies (COGS) at Digital Commons@Georgia Southern. It has been accepted for inclusion in Electronic Theses & Dissertations by an authorized administrator of Digital Commons@Georgia Southern. For more information, please contact digitalcommons@georgiasouthern.edu.

POLYMORPHIC DATA MODELING

by

STEVEN BENSON

(Under the Direction of Vladan Jovanovic)

ABSTRACT

There are currently no data modeling standards for modeling NoSQL document store databases. This work proposes a standard to fill the void. The proposed standard is based on our new data modeling pattern named *The Polymorphic Table Pattern*. The pattern embraces the “schemaless” nature of document store NoSQL while allowing the data modeler to use his or her existing skillsets. The concepts of our proposed modeling have been demonstrated against MongoDB.

INDEX WORDS: Polymorphism, Data modeling, NoSQL, IDEF1X, MongoDB, Document store

POLYMORPHIC DATA MODELING

by

STEVEN BENSON

B.S., Winthrop University, 1998

A Thesis Submitted to the Graduate Faculty of Georgia Southern University in

Partial Fulfillment of the Requirements for the Degree

MASTER OF SCIENCE

STATESBORO, GEORGIA

©2014

STEVEN BENSON

All Rights Reserved

POLYMORPHIC DATA MODELING

By

STEVEN BENSON

Major Professor: Vladan Jovanovic

Committee: Lixin Li
Wenjia Li

Electronic Version Approved:
May, 2014

DEDICATION

To my Lord and Savior Jesus Christ, to whom I give all the honor and credit for the Polymorphic Table modeling pattern. I thank You for entrusting this wonderful discovery to me.

ACKNOWLEDGEMENTS

I would like to thank Dr. Vladan Jovanovic for his patience, time, and wisdom for helping through this process. I have appreciated all the guidance that he has provided over the years. Last but not least, I would like to thank my family. I would especially like to say thank you to my beautiful and loving wife, who encouraged me to complete my degree when I felt like giving up. I would also like to thank my two beautiful little girls who have loved me unconditionally even though our family time was reduced while I was in the master's program. Daddy loves you.

Table of Contents

ACKNOWLEDGEMENTS.....	6
LIST OF TABLES	11
LIST OF FIGURES.....	12
CHAPTER 1	14
1.1 Purpose of Study.....	14
CHAPTER 2	17
2.1 NoSQL Data Modeling	17
2.2 Conceptual XML Data Modeling.....	17
2.3 E-R Model Based Approaches	18
2.4 Hierarchical Based Approaches.....	20
CHAPTER 3	21
3.1 General	21
3.2 Embedding.....	21
3.2.1 One to One Relationship.....	21
3.2.2 One to Many Relationship	22
3.3 References.....	23
3.3.1 <i>One to Many Relationships</i>	23
3.4 Comparisons to XML Schema Styles.....	25
3.4.1 Embedded vs Russian Doll	25
3.4.2 References vs Russian Doll.....	26
3.4.3 Embedded vs Salami Slice	26
3.4.4 References vs Salami Slice	26
3.4.5 Embedded vs Venetian Blind	26
3.4.6 References vs Venetian Blind.....	26
3.4.7 Embedded vs Garden of Eden.....	26
3.4.8 References vs Garden of Eden.....	27
CHAPTER 4	28
4.1 Overview.....	28
4.2 General NoSQL Data Model Requirements.....	28
4.2.1 NoSQL Implementation Agnosticism	28

4.2.2 Formal Foundations	28
4.2.3 Data Description	28
4.2.4 Hierarchical Representation	28
4.2.5 Graphical Representation	29
4.3 Data Modeling Construct Requirements.....	29
4.3.1 Entity Identification	29
4.3.2 Identifying Property	29
4.3.3 Unique Property Constraint.....	29
4.3.4 Required/Optional Property	29
4.3.5 Data Type Property	29
4.3.6 Complex Objects	30
4.3.7 Cardinality	30
CHAPTER 5	31
5.1 Overview.....	31
5.2 New Approach: Polymorphic Pattern Formalization and Explanation.....	32
5.2.1 Polymorphic Table Entity (PTE).....	32
5.2.2 Polymorphic Table Column (PTC)	32
5.2.3 Polymorphic Table Column Simple (PTCS).....	33
5.2.4 Polymorphic Table Column Value Simple (PTCVS)	33
5.2.5 Polymorphic Table Column Complex (PTCC)	33
5.2.6 Polymorphic Table Column Attribute (PTCA)	34
5.2.7 Polymorphic Table Column Value Complex (PTCVC).....	34
5.2.8 Polymorphic Table Child Column Bridge (PTCCB).....	34
5.2.9 Polymorphic Table to Polymorphic Table Bridge (PTB) and Owner Container (OC)	35
5.2.10 Standalone Polymorphic Table Entity (SPTE).....	35
CHAPTER 6	36
6.1 Relational Model (RM) Example.....	36
6.2 RM to Logical Model Transformation – Parent Entity	36
6.3 RM to Logical Model Transformation – Super-type and Subtype.....	37
6.4 RM to Logical Model Transformation – PTE’s Dependent Entity.....	39
6.5 RM to Logical Transformation – PTB and OC.....	40
6.6 Physical Modeling Application.....	41
6.6.1 Table Renaming	41

6.6.2 Polymorphic Table Key Specification	41
6.6.3 SQL Data Type Specification	42
6.6.4 Detailed Primary Key Specification	43
6.6.5 Detailed Index Specification	43
6.6.6 Referenced Attribute Identification.....	44
CHAPTER 7	45
7.1 Meta-schema Approach Explanation.....	45
7.1.1 Schema.table.global.columns Collection	46
7.1.2 Schema.tables Collection.....	46
7.1.3 Schema.table.containers Collection	46
7.1.4 Schema.table.columns.simple Collection	47
7.1.5 Schema.table.columns.complex Collection	47
CHAPTER 8	49
8.1 Model Requirements Implementation.....	49
8.1.1 General NoSQL Data Model Requirements	49
8.1.2 Modeling Constructs.....	50
8.2 Meta-Schema Enforced Documents (Experimental Data).....	52
8.2.1 PT_Project Document Validation.....	52
8.2.2 PT_ContractChangeOrder Document Validation.....	55
CHAPTER 9	57
9.1 Required Skillset – IDEF1x.....	57
9.2 Required Skillset – Data Model Refactoring.....	58
9.3 Required Skillset – XML.....	59
CHAPTER 10	61
Bibliography.....	62
APPENDIX A.....	65
A.1 Meta-schema Collection – Schema.tables.....	65
A.2 Meta-schema Collection – Schema.table.containers.....	66
A.3 Meta-schema Collection – Schema.table.global.columns.....	68
A.4 Meta-schema Collection – Schema.table.columns.simple.....	69
A.5 Meta-schema Collection - table.columns.complex.....	72
APPENDIX B.....	78
B.1 MongoDB.....	78

B.1.1 What is MongoDB?	78
B.1.2 Document Object	78
B.1.3 Collection Object.....	78
B.1.4 Data Types.....	79
B.1.5 Indexing.....	79
B.2 JSON.....	79
B.2.1 What is JSON?	79
B.2.2 JSON Object.....	80
B.2.3 Value	80
B.2.4 Array.....	81
B.3 XML Schema Definition Language.....	81
B.3.1 What is XML Schema Definition Language?.....	81
B.3.2 XSD Features	82
APPENDIX C.....	86
C.1 Mongo Data Import Statements.....	86
APPENDIX D.....	87
D.1 Schema.tables.....	87
D.2 Schema.table.global.columns.....	88
D.3 Schema.table.containers.....	88
D.4 Schema.table.columns.simple.....	89
D.5 Schema.table.columns.complex.....	108
D.6 PT_Project.....	124
D.7 PT_Drawing.....	125
D.8 PT_ContractChangeOrderMemo.....	127
D.9 SPT_Contractor.....	128
D.10 PT_ContractChangeOrder.....	129
APPENDIX E.....	132

LIST OF TABLES

Table 1 - Examples of supported SQL data types	42
Table 2. Relationships from logical relational model	58
Table 3 XSD data types	82
Table 4 XSD indicators	84

LIST OF FIGURES

Figure 1. IDEF1x entity relationship.....	14
Figure 2 NoSQL one to one embedded relationship	22
Figure 3. No SQL one to many embedded relationship	22
Figure 4. Owner document to be referenced.....	23
Figure 5 – Owner document embedded in Car document.....	24
Figure 6. Car documents referencing owner document	25
Figure 7. Polymorphic Table pattern	31
Figure 8. Relational Model Exemplar	36
Figure 9 – Relational exemplar post refactoring	38
Figure 10 Car XML.....	39
Figure 11 – PTE Key specification	42
Figure 12 - Index Specification	44
Figure 13 – Schema.table.global.columns sample	46
Figure 14 – Schema.tables sample	46
Figure 15 – Schema.tables.containers sample	47
Figure 16 – Schema.table.columns.simple sample	47
Figure 17- Schema.table.columns.complex sample	48
Figure 18 – PT_Project document	52
Figure 19 – PT_Project meta-schema.....	52
Figure 20 – Container document.....	53
Figure 21 – PT_Project PTCS meta-schema.....	54
Figure 22 – PT_ContractChangeOrder document	55
Figure 23 – PT_ContractChangeOrder meta-schema.....	55

Figure 24 MongoDB document example.....	78
Figure 25 JSON Object example.....	80
Figure 26. JSON Array example	81
Figure 27 XML sample document.....	83
Figure 28 XSD sample document.....	83
Figure 29 Logical Model - PT_ContractChangeOrderMemo	132
Figure 30 Logical Model – PTCC_Drawing_DrawingIndex.....	133
Figure 31 Logical Model – OC diagram.....	134

CHAPTER 1

INTRODUCTION

1.1 Purpose of Study

The NoSQL database movement's rise in popularity has created a new frontier for data modeling. The "schemaless" nature of NoSQL presents new challenges for data modeling. The major data model of the past two decades is the relational data model [32]. The relational data model is built upon Codd's research [8]. In the relational model, data is stored in schema defined tables [10]. The columns which define the table can only store a single value [32]. NoSQL does not follow the relational model's notion of defined schema. Instead, NoSQL databases are often described as "schemaless" [32]. The *schemaless* nature of the NoSQL databases does not align with traditional data modeling. A NoSQL data model would provide the data modeler with the tools to effectively integrate the *NoSQL* data with related data from relational database sources (e.g. data warehousing environment). The resulting model would serve as a blueprint for the data integration.

Since our work is focused on the analysis of data prior to its storage in a NoSQL database, we will investigate the viability of using an interim data model (which can be used later for integration purposes). Eventually, the interim model can be added to metadata (to provide necessary comprehensive data governance) and systematically translated into NoSQL. We will use IDEF1x standard data modeling notation in this paper as a reference entity relationship notation (as it is very close to the relational model). The mapping between IDEF1x and the relational model is direct *entities* represented as relations (tables). Each *attribute* within the entity is a relational attribute (table column). Using a contemporary tool such as Erwin for visualization of data models, the modeler selects an *attribute* as a *primary key* (PK) and draws IDEF1x relationships to connecting *entities*. As a result, the PK is automatically passed as either foreign keys (FK) that become part of the PK or simply a FK (in the latter case, additional semantics will need to be captured to specify optional/mandatory status of the FK).

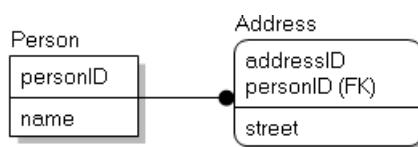

Figure 1. IDEF1x entity relationship

During the transformation of the logical model to the physical model, data types are assigned to each entity's attributes. The model can be transformed to DDL statements through an automated process, and the statements are used to generate the new database schema. This process works well for the relational model, but fails for the NoSQL document store model. We will use the term *NoSQL* to refer to the document store NoSQL databases for the remainder of the paper.

One problem with current data modeling techniques is that they do not account for the "aggregate" aspect of document store NoSQL databases. The term *aggregate* is defined by Eric Evans [14]. An *aggregate* is

a collection of related objects that are treated as one unit [32]. In our case, a NoSQL document is the unit of work, and each sub-document, key-value array, or key-value pair is a related object. The aggregate notion gives the NoSQL database the ability to express complex structures that are not possible (or very difficult) to implement in the relational model. The relational model is confined to storing data inside a limited data structure otherwise known as a tuple [32]. Although the tuple is capable of storing a set of values, it is unable to store another tuple. In other words, nesting of records is not possible. Therefore a tuple can represent one and only one data record. This is completely opposite of the NoSQL *document* object. The *document* object is a flexible structure which allows for nesting of records and storing of non-uniform data [32]. This leads us to our first question, “How do we model the document object in a data model?”

There are several parts of the document object which will need to be defined such as data type assignments, primary and alternate key identification, and foreign key identification. All are areas of the data modeling process that are lacking for NoSQL. We could easily create an IDEF1x entity, and use it to represent the document container itself. But, that is where the process would end. There must be a way to represent the key-value arrays, key-value, or subdocuments of the document object. There must also be a way to represent the aggregate relationship of those components to the document itself. We previously stated that the *document* object has the capability to store non-uniform data. In the context of this paper, non-uniform data refers to data where each record contains a different field set [32]. In the relational model, this can be accomplished through nullable columns which can lead to sparse tables. Or, the modeler could use generic named columns (e.g. Column1, column2). The NoSQL document allows the application (or input source) to store whatever fields it wants to store (without adhering to a defined schema). This behavior is not allowed in the relational model due the defined schema. The liberty granted by the “*schemaless*” aspect is not without consequence. The responsibility of schema awareness is transferred from the database system to the application layer. This shift in responsibility leads to the creation of implicit schema [32] in the application code. The schema is implicit because the code behavior (selects, inserts, updates, and deletes) could be used to derive a possible database schema. This is not a fool-proof method of schema derivation because there could be other applications that use the database. In this case, the information stored by one application could be different from the information stored by a previous application. This leads us to another issue that will need to be addressed, “How do we create an explicit schema for a NoSQL database?” In addition explicit schema declaration, there must be a way to transform the physical model to a physical implementation. Currently tools (e.g. Erwin), do not support this transformation for NoSQL.

We are aware that what we are requiring pushes the boundaries of current data modeling. The concepts that NoSQL bring are in some cases completely new to the data modeler. However, the new concepts are not foreign to the application developer. For example, a document could be represented as a *class* in an object-oriented programming language (e.g. C#). The key-value pair array could be represented as an array of *dictionary* key-value pairs. A *sub-document* could be represented as a *class property* of type *document*. As you can see, the NoSQL concepts seem to map to object-oriented programming languages fairly well. We want to combine concepts like the aforementioned (from our software engineering experience) with relational data modeling to produce an innovative, thorough data modeling solution. It is our belief that the emergence of NoSQL as a viable data storage option warrants the thorough data modeling solution we are proposing.

In our quest for a NoSQL data modeling solution, we want to ensure that the skillset of the relational data modeler is not lost. Although, the responsibility of schema enforcement has been shifted to the application, the data modeler will continue to be an important factor in the database design. We want a data modeling solution that will allow the data modeler to continue to use the IDEF1x modeling language in their current data modeling tool of choice. For our proposal we want our solution to work for the Erwin Data Modeler software.

The remainder of this paper is organized as follows. In Section 2 we provide a brief overview of some NoSQL and conceptual XML data modeling research. Our requirements for our NoSQL Data Model are specified in Section 3. In Section 4 we introduce the Polymorphic Table pattern. We apply the Polymorphic Table to a real world example in Section 5. In Section 6 we demonstrate the physical implementation of the NoSQL data model. The validation of our approach is presented in Section 7. A discussion of comparative advantages is presented in Section 8. Lastly, we present our conclusions in Section 8.

CHAPTER 2

STATE OF ART REVIEW

2.1 NoSQL Data Modeling

To the best of our knowledge, there are no standard data modeling practices (in previous literature) for NoSQL databases. Data modeling, in this context, refers to the representation of a database using a data modeling tool. We proposed the *Aggregate Data Modeling Style* [17] in our previous work to address the lack of NoSQL data modeling standards. In the *Aggregate Data Modeling Style*, IDEF1x [19, 25] is used to define a modeling style for NoSQL document store databases. The first step in using the proposed style involves creating the conceptual data model using traditional data modeling techniques. The conceptual model in this case includes detailed analysis of all entities, attributes, and relationships (which are necessary to satisfy the functional requirements). New operators are later introduced to convert the models into their aggregate forms. The modeling style proposal mandates that specific domain analysis be performed to identify aggregates and references. The use of traditional data modeling techniques is an idea we wish to embrace in our new solution. The *Aggregate Data Modeling Style*'s new operators are also in alignment with our goals to provide clarity when modeling aggregates.

The *Aggregate Data Modeling Style* advocates the use of patterns to achieve its end state. Single dependency modeling patterns, specifically, are used during the creation of the conceptual models. They are also used as a first step in transforming a traditional relational model [17]. The data models are then reduced by eliminating relationships through either the copying of reference identifiers or by nesting entities. The concept of a ROOT operator is proposed to designate an entity as a root entity. Two additional operators are also proposed, *REFI* and *EMBED*. Both operators are used to identify the relationships that will be eliminated during the relational to aggregate transformation. The *REFI* operator is used to “cut a network (graph) to trees” [17]. The reference concept (invoked by the *REFI* operator) pays respect to the referential integrity constraint which is ordinarily enforced in the relational model through the use of foreign keys [10]. The data integrity that is offered by the constraint is important to our data modeling solution. The *EMBED* operator is used to reduce the size of the model by explicitly nesting the related entities. The nesting of the related entities can be correlated to parent-child element relationships in an XML document [43].

2.2 Conceptual XML Data Modeling

We next turn our attention to the closely related topic of conceptual XML modeling. XML is currently used in various areas in technology world. It is used as a common format for data exchange in business to business systems. It has also been used to create use create database systems. Some researchers have used XML as a logical database model. Researchers have found ways to store xml in relational databases [24]. Other researchers have experimented with publishing relational data as XML [35]. Nevasky's survey of conceptual XML modeling approaches [26] examines the *E-R* [5] and hierarchical based modeling approaches. He proposes a list of requirements for conceptual XML models. The requirements are broken into two groups: *general*

requirements and *modeling constructs requirements*. Nevasky uses the *general requirements* to establish the end-goal of XML conceptual modeling [26]. The *modeling construct requirements* are used to specify the types of modeling constructs that the conceptual model should support. The first three general requirements [26] (independence on XML schema languages, formal foundations, and graphical notation) can be adapted to provide a foundation for our modeling endeavor. The first requirement specifies that the conceptual model should not be dependent upon any particular XML schema language. The idea of version agnosticism is relevant to our NoSQL model. We would like for our model to be applicable to any document based NoSQL database. The second requirement, which mandates that the modeling constructs be formally defined, will be adopted for use in our research. Lastly, the third requirement specifies the need of a “user-friendly graphical notation” for the modeling constructs. This requirement specifies a core end-goal that should be included in our research. We will now focus our attention on E-R based modeling approaches.

2.3 E-R Model Based Approaches

Badia proposes the *Extended E-R Model* for modeling XML in [2]. The premise of his research is to develop an *E-R* model that can model both structured and semi-structured data [2]. He discovers a minimal set of E-R extensions through a transformation which converts an XML DTD into an *E-R* model [2, 26]. The minimal extension set is composed of two “small steps” that grant E-R models the ability to represent all of the DTD model’s semantics. The two proposed steps are 1) *optional* and *required* attributes and 2) *choice* attributes. Badia’s proposal requires that all attributes are marked as either optional or required. The objective is to allow the data modeler to precisely specify what is required for an instance of an entity. The *choice* attribute gives an entity the ability to have one value or another. The attribute can further be categorized as *inclusive* (an entity can have a value for all of the pool of possible attributes) and *exclusive* (an entity can only have a value for one of the possible attributes). The concept of *optional* and *required* attributes will be explored in our modeling proposal.

The *ERX (Entity Relational XML) Model* is an “evolution of the Entity Relationship model” [29]. Psaila introduces the following five principle components to facilitate XML modeling: entities, relationship types, attributes, hierarchies, and interfaces. The entity represents a complex, but structured concept of an xml document. The entity concept used by *ERX* can be applied to the *document* object [6] of a NoSQL document store. In *ERX*, each entity is represented by a rectangle with solid lines. An entity can also be an *instance* which is a particular occurrence of the structured concept in the xml document. *ERX* distinguishes entities as either *strong* or *weak*. *Strong* entities are entities which represent *primary* concepts in the source xml document. This type of entity is represented using “thin lines”. *Weak* entities are source xml document concepts that are defined within the context of another concept [29]. The entities are represented using “thick lines”. The distinction between *strong* and *weak* entities is important to our pursuit of a viable data modeling solution. We could possibly map the terms to a NoSQL *document* in the following manner. The root *document* itself could be considered as a *strong* entity, while the embedded sub-document would be considered a *weak* entity. Other conceptual modeling research such as the UXS conceptual model [9] does not make the distinction between the two entity types.

Attribute representation is another important concept that *ERX* addresses. In *ERX*, the entity's attributes usually correspond to the XML tag attributes of a document [29]. The attributes are visually represented with small circles which contain the attribute's name (traditional E-R notation). The attribute symbol is connected to its associated entity by using a solid line [29]. *ERX* makes use of a solid, black circle to denote key attributes. *ERX* enhances the descriptive power of attributes by allowing attribute names to be associated to *qualifiers*. The role of the qualifiers is to specify different properties of the attribute such as *required*, *implied*, *unique*, etc. The attributes are denoted within parentheses adjacent to the attribute's name. An attribute can be *required* (*R*) or *implied* (*I*). The *implied* qualifier specifies that the attribute is optional. The *unique* qualifier is used to identify non-key attributes. The concept is similar to unique keys in the relational model. Finally, attribute order is specified using the *order* (*O*) qualifier [26, 29].

Relationships in *ERX* are used to describe the manner in which two entities are connected. Each relationship is visually represented with a rhomb, which is then labeled with the relationship's name. *Cardinality constraints* are also available in the *ERX* proposal. The format of the constraint is *l:u*. The constraint specifies each entity of *X* in respect to *Y*. The model also devises a manner in which to represent *containment* relationships. This is a stark contrast to the *Extended E-R Model* that does not provide specific constructs for modeling hierarchies [26, 29]. In *containment* relationships, entity *X* contains *instances* of entity *Y*. This is similar to the *EMBED* concept presented by the *Aggregate Modeling Style* [17] and the *inclusion* relationship explained in [18]. Similar concepts of *containment* relationships are found in [21, 40]. The *containment* relationship is represented with a normal relationship with a dashed arrow connecting to the entity *X* side of the rhomb. Psaila instructs the modelers to limit the use of containment relationships by abstracting (as much as possible) the actual xml document's structure. It is necessary at this point to review the Whitehead's containment modeling work [18].

The intent of the research [18] is to describe containment relationships and containment data models, and apply the concepts to model link servers and hyperbase systems [7]. However, the containment concepts are applicable to developing a NoSQL data modeling solution. The containment model proposes that an aggregation of data items should not be modeled by using attributes to represent its properties and contents [18]. Instead, Whitehead proposes the use of entities to represent the properties and contents. The entities are related to the parent entity (*container*) through the use of an *inclusion* relationship. In an *inclusion* relationship, the child entities are physically included in the *container* (parent entity). This is similar in principle to the concept embedding [17] and inclusion [29]. The containment modeling work also provisions for the representation of *referential* relationships. The notion of referential relationships is also used in the graph-semantic based conceptual modeling approached proposed in the GOOSSDM [33] proposal.

The abstract container properties that are established in container modeling may be of significant use in NoSQL data modeling. The abstract properties are *containment*, *membership*, and *ordering*. The *containment* property indicates how many containers (parents) can hold the entity. This property could possibly be incorporated in to our solution to help address hierarchies in the NoSQL document object. *Membership*, the second abstract property, represents the number of times a container can hold a given entity [18]. The property's concept is similar to the *occurrence indicators* [37] used in the XSD specification. The manner in

which to denote the occurrences of attributes and sub-documents in the parent NoSQL document may be an area of interest in our solution.

The last *E-R* model based model that will be examined is the *ERex* [22] model (proposed by Mani). Mani's proposal endeavors to incorporate XML features such as union and recursive types that are largely missing from UML [30] and ORM [3] based modeling. He extends the *E-R* model by adding a new structural specification and two new constraint specifications. The new structural specification is called *categories*. Its purpose is to categorize entity types in the model. *Category relationship types* (a type of binary relationship that bears similarity to the *E-R* model's IS-A relationship type) are used to model the entity types [22, 26]. The new relationship type allows the categorized entity type to be null or empty. The coverage constraints are described as either *exclusive coverage* or *total coverage*. The coverage constraints will not be a part of our proposal; therefore an extended discussion of the constraints will be omitted. Lastly, Mani provisions his modeling proposal with the ability to specify the ordering of entities. The concept of ordering is lacking in the *ERX* [29] modeling proposal. This ordering capability is accomplished with the *ordering* constraint [22]. This notion of ordering is also a part of the Whitehead's Containment Modeling work [18].

2.4 Hierarchical Based Approaches

The *E-R* model extensions, such as proposed in [2, 22, 29], allows for conceptual schemata to be expressed using a graph structure [26]. This graph-like representation does not fully capture XML's ability to express relationship types. XML Schema [37] uses the concepts of referencing and nesting to express XML relationship types.

Hierarchies are also addressed in *ERX*. The hierarchy is modeled similar to a generalization in UML [38]. Ground rules are established for the hierarchy representation. First, only the *super-entity* can specify key attributes. Second, all the *super-entity*'s attributes are inherited by its children (or *sub-entities*). We will take a different approach. Our approach should allow for key specifications for sub-entities as well.

CHAPTER 3

A NOSQL MODELING STYLE

3.1 General

A document store NoSQL database has flexible schema. This differs than that of a relational database in which schema must be established before it can be used. NoSQL data modelers must take into consideration the way in which the application(s) will use (query, insert, update, delete) in addition to the structure of the data itself [23]. These aforementioned considerations affect the how data relationships will be represented in the data model. Currently, there are two conventions for modeling the data relationships: *embedding* and *references*.

3.2 Embedding

Embedding documents is a NoSQL practice in which all the related data for an entity is stored in a single document [23]. The stored data in this case is *denormalized*. NoSQL databases can benefit from denormalization (similarly as in the case of relational databases). Atomic writes is one advantage of using the embedded approach. Data can be inserted or updated during a single operation, as opposed to multiple operations that would be necessary in a normalized data model [23]. Data locality is another benefit of document embedding [11, 23]. In the case of embedding, all the data is stored together on the same disk which results in faster data reads. Denormalization also has its share of NoSQL concerns. Documents sizes are governed by the NoSQL database system. Embedded document could grow rather quickly and reach the preset maximum size limit. An additional side effect is an issue with data consistency. If one of the embedded documents needs to be updated, then all documents that contain the embedded document must be updated [11, 23].

3.2.1 One to One Relationship

Consider the following scenario that maps students to their phone numbers. In the *one to one* relationship (as it applies to this scenario), a student has at most one phone number. This relationship is demonstrated below.

```

{
  "_id": "studentA",
  "name": "Scholar Owl",
  "classification": "senior",
  "phone": {
    "phoneNumber": "704-888-8111",
    "phoneNumberType": "mobile"
  }
}

```

Figure 2 NoSQL one to one embedded relationship

3.2.2 One to Many Relationship

Suppose that there was a requirements change that allows students to have more than one phone number. How would the *one to many* relationship be represented in the document? Particularly in JSON based documents (e.g. MongoDB), multi-valued *columns* are store their values in an array. The *one to many* relationship is pictured below.

```

{
  "_id": "studentA",
  "name": "Scholar Owl",
  "classification": "senior",
  "phone": [
    {
      "phoneNumber": "704-888-8111",
      "phoneNumberType": "mobile"
    },
    {
      "phoneNumber": "704-777-9541",
      "phoneNumberType": "home"
    }
  ]
}

```

Figure 3. No SQL one to many embedded relationship

3.3 References

References in NoSQL are similar to foreign keys in the relational model. The references store the data relationships by using links that allow navigation to one document from another. The primary key (identifier) often used to as this link. The use of the references closely corresponds to a *normalized* relational data modeling approach. Although a normalized approach may be a desired approach in data modeling, it can create performance issues for NoSQL. Document store NoSQL database systems do not have native join functionality, which is present in relational databases management systems. The desired join operations have to be created by the application layer through the use of additional queries. Another performance concern is the locality of the documents that are being referenced. The referenced documents could be located on a different hard drive disk which could result in a longer *seek* time [11, 12].

The use of references also brings a set of advantages for the physical implementation. The NoSQL database systems enforce a maximum size limit for documents (*e.g.* Mongo enforces a 16MB maximum size) [11, 12]. The replacement of embedded documents with references can reduce the size of the overall document. References also reduce the amount of updates that would be necessary if the referenced documents were actually embedded. In the reference scenario, there would be an update to the referenced instead document only.

3.3.1 One to Many Relationships

Consider the following scenario which maps car owners to their cars. Suppose we decided to embed the car owner document inside the car document. This would lead to the following documents:

```
{
  "_id": 123,
  "owner": "Bob",
  "age": 33,
  "state": "NC"
}
```

Figure 4. Owner document to be referenced

```
{
  "_id": "carA",
  "make": "Dodge",
  "model": "Caliber",
  "licensePlate": "EQA 3213",
  "owner": {
    "_id": 123,
    "owner": "Bob",
    "age": 33,
    "state": "NC"
  }
},
{
  "_id": "carB",
  "make": "Toyota",
  "model": "Camry",
  "licensePlate": "TXE 9845",
  "owner": {
    "_id": 123,
    "owner": "Bob",
    "age": 33,
    "state": "NC"
  }
}
```

Figure 5 – Owner document embedded in Car document

Any update to the owner information would require that both car documents be updated. A referenced based approach embeds the `_id` of the owner in lieu of the owner document itself. Therefore any updates to the owner document would only affect the owner document itself. We have adapted the previous scenario to use references. The resulting documents are shown below.

```

{
  "_id": "carA",
  "make": "Dodge",
  "model": "Caliber",
  "licensePlate": "EQA 3213",
  "owner": 123
},
{
  "_id": "carB",
  "make": "Toyota",
  "model": "Camry",
  "licensePlate": "TXE 9845",
  "owner_id": 123
}
{
  "_id": "carA",
  "make": "Dodge",
  "model": "Caliber",
  "licensePlate": "EQA 3213",
  "owner": 123
},
{
  "_id": "carB",
  "make": "Toyota",
  "model": "Camry",
  "licensePlate": "TXE 9845",
  "owner_id": 123
}

```

Figure 6. Car documents referencing owner document

3.4 Comparisons to XML Schema Styles

XML Schema can be classified (but not limited to) into the following design patterns: *Russian Doll*, *Salami Slice*, *Venetian Blind*, and *Garden of Eden* [15]. We will now contrast the each of the document modeling styles with the aforementioned XML Schema design patterns.

3.4.1 Embedded vs Russian Doll

The *embedded* document modeling style is very similar to the *Russian Doll*. In the *Russian Doll* design pattern, there is only one global element. Only the root node can be defined in the global namespace. All other elements are local to the root node [15]. This means that the local elements are not reusable. These features parallel the embedded document features. In order to make our contrast we will consider the document itself to

be the global element. Each embedded document thereafter would be local. The embedded document behaves the same as the local element in the fact it cannot be reused.

3.4.2 References vs Russian Doll

The references document modeling style differs from the *Russian Doll* design. In the *references*, the referenced document is not local to the global parent document.

3.4.3 Embedded vs Salami Slice

In the *Salami Slice* design pattern, all elements are global. The resulting xml document contains all reusable elements [15]. Reuse an embedded document is not possible in the embedded modeling style. Therefore, the embedded modeling style is unlike the *Salami Slice* design pattern.

3.4.4 References vs Salami Slice

The *references* document modeling style is similar to the Salami Slice pattern. The referenced document is a global document whose key identifier is stored in the parent document. The parent document is also global document. However there is a difference between the references style and the *Salami Slice*. The parent document can contain types that are not declared globally (which conflicts with Salami's "global" nature).

3.4.5 Embedded vs Venetian Blind

The *Venetian Blind* design pattern is an extension of the *Russian Doll* pattern. There is only one global element in the *Venetian Blind* pattern. It differs from the *Russian Doll* pattern in the fact that all types are defined globally [15]. Only parent document in the embedded modeling style is global, and all complex types (embedded documents) are "defined" locally. Therefore, the embedded modeling style is unlike the *Venetian Blind* pattern.

3.4.6 References vs Venetian Blind

The *references* document modeling style differs from the *Venetian Blind* pattern in the fact that types are not required to be global (a choice of the data modeler). The *referenced* document itself could be considered as a global type, but the remaining "elements" of the parent document could local. Therefore the *references* style is different from the *Venetian Blind* pattern.

3.4.7 Embedded vs Garden of Eden

The *Garden of Eden* design pattern combines the *Salami Slice* and *Venetian Blind* design patterns. The pattern combination results in a pattern where all types and elements are defined in the global namespace [15]. This is contrary to the *embedded* document modeling style in the fact that neither the parent document's types (subdocuments) nor "elements" are global.

3.4.8 References vs Garden of Eden

The *references* document modeling style is not similar to the *Garden of Eden* design pattern. Given its previous determined differences between both the *Salami Slice* and *Venetian Blind*, it can be logically that *references* document is not similar to the *Garden of Eden* design pattern.

CHAPTER 4

NOSQL DATA MODEL REQUIREMENTS

4.1 Overview

In this section, we will present our requirements for creating data models for NoSQL document stores. The requirements are separated into the following categories: *general NoSQL data model requirements* and *NoSQL data modeling construct requirements*. The *general data model requirements* category will contain a brief explanation of core concepts that we wish to address in our NoSQL data modeling effort. The *NoSQL data modeling construct requirements* category will contain explain the types of modeling constructs that will be supported by the NoSQL data model.

4.2 General NoSQL Data Model Requirements

4.2.1 NoSQL Implementation Agnosticism

The data model will not be dependent upon a particular vendor's NoSQL database implementation. There should be no special concessions or favoritism granted towards a particular document store. The created model should be completely applicable to any variety of the document store model whose primary document object is based on JSON [13] or XML [43].

4.2.2 Formal Foundations

We will base our *formal foundations* requirement on Necasky's requirement [26]. The modeling constructs should be specified in such a way as to allow for model comparisons. The construct specification should also describe operations on the model's structures.

4.2.3 Data Description

The data model should provide base SQL data types [10] for all atomic attribute values. The model will create constructs for the identification of primary, unique, and foreign keys. The model should also support the notion of irregular or semi-structured data.

4.2.4 Hierarchical Representation

The data model should provide constructs to represent the hierarchical nature of NoSQL data. The constructs should allow for the nesting of both complex and simple types.

4.2.5 Graphical Representation

The data model should provide a standard set of guidelines for the visual representation of the entities, attributes, and all other constructs. The guidelines should be provided in such a manner as to allow for the creation of consistent data models. The data model shall use colors to make distinctions between different entity types [16].

4.3 Data Modeling Construct Requirements

4.3.1 Entity Identification

The data model should provide a mechanism to identify an instance of an entity. The mechanism should allow for particular entity naming conventions. The mechanism should allow the use of alphanumeric sequences. For example, an entity could be named “ABC” or “ABC123”.

4.3.2 Identifying Property

The data model should provide a manner in which to specify the unique identifier or “primary” key for each modeled entity. The specification should be clear and concise. The model should also allow for multi-part unique identifiers.

4.3.3 Unique Property Constraint

The data model should provide a mechanism to uniquely identify an *embedded* entity within the scope of the parent entity. This concept is similar to the unique key constraint in relational data modeling [10], but is local in scope to the parent entity.

4.3.4 Required/Optional Property

The data model should provide constructs to address the polymorphic nature of the NoSQL documents. The constructs should provide the model with the ability to notate entities and attributes as required or optional attributes. This construct will empower the model to represent the flexibility of data storage options in the document object.

4.3.5 Data Type Property

The ability to express data types for attributes must be available in the model. The constructs must be very specific in detail such that intended data type is accurately represented. At a minimum, the constructs must support a subset of basic SQL data types [10]. The data types are necessary for the possible future exportation of the NoSQL data to a relational database.

4.3.6 Complex Objects

The data model must allow for the creation of complex objects. The complex types must be composed of simple and/or other complex objects. The complex object is necessary for the complete expression of the document object.

4.3.7 Cardinality

The data model should provide constructs to define the minimum and maximum number of object instances that can participate in a relationship. At the very least, the constructs should be provided for the following relationship types: *1:1* and *1:M*. The data model may take liberty and imply a *1:1* relationship by omitting the construct from the model.

CHAPTER 5

POLYMORPHIC TABLE (PT) PATTERN

5.1 Overview

The inspiration for the *Polymorphic Table Pattern* (PT Pattern), Figure 7, comes from the computer science concept of *polymorphism* and the concept of *aggregation*. *Polymorphism* is sometimes referred to as the third pillar of object-oriented programming [20]. *Polymorphism* is derived from the Greek word, *polumorphos*. *Polumorphos* contains two roots, *Polus* and *Morphe*. *Polus* means many, and *Morphe* means shape or form. The combination of the two roots gives the meanings “many-shaped” or “having many forms” [27]. Cardelli and Wegner refined the work of Strachey, who informally distinguished parametric polymorphism

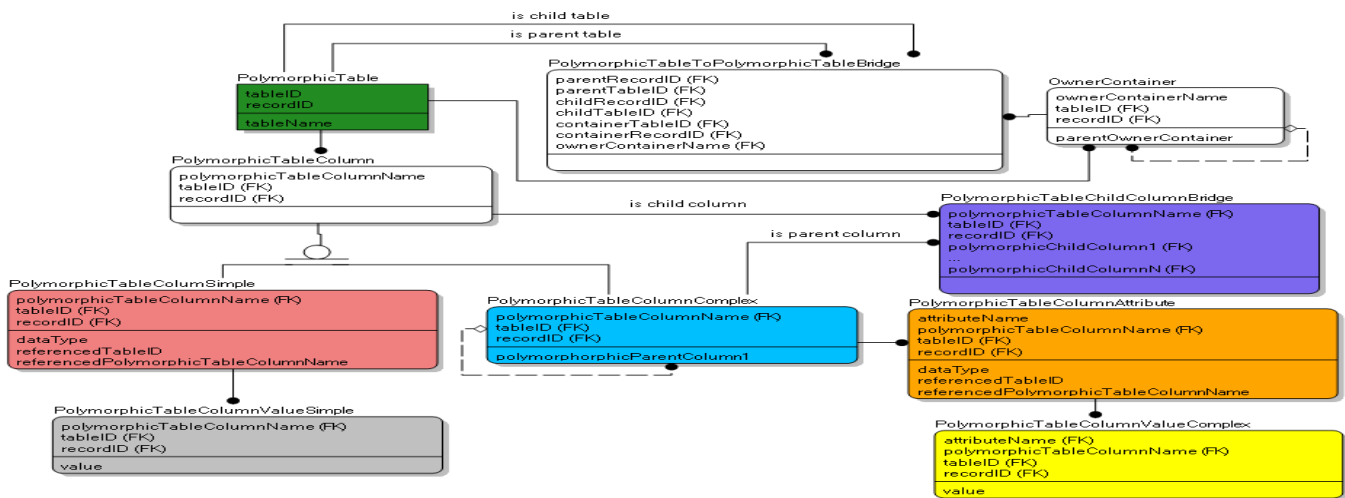

Figure 7. Polymorphic Table pattern

from ad-hoc polymorphism, by introducing a new form type of polymorphism referred to as *inclusion polymorphism* [4]. *Inclusion polymorphism* is used to model subtypes and inheritance. According to Cardelli and Wegner, subtyping is an instance of inclusion of polymorphic inclusion. They deemed subtyping useful for representing sub-ranges of ordered types, but also for complex types [4]. Even though polymorphism applies to object-oriented principles, it also applies to database design.

A *model* is an abstraction of a system in which certain details are deliberately omitted [36]. In Codd’s relational schema [8], two forms of abstraction are supported. Smith and Smith refer to the abstraction types as *aggregation* and *generalization*. *Aggregation* refers to the instance in which the relationship between two objects is regarded as a higher object [36]. The previous definition coincides with the aggregate notion in the world of Domain-Driven design. Eric Evans defines an *aggregate* as a cluster of associated objects that are treated as a unit for the specific purpose of data changes [14]. Each *aggregate* consists of a *root* and a *boundary*. The *root* is a single entity located within the aggregate. The *boundary* defines the composition of the aggregate [14]. Evans gives assigns the following properties to an aggregate. 1) The *root* is the only component

of the aggregate that can be referenced by an outside object. 2) The remaining entities have local identities. 3) An aggregate can hold the reference to the root of other aggregates [39].

Generalization can be defined as “an abstraction which enables a class of individual objects to be thought of generically as a single named object” [36]. Smith and Smith deemed that generalizations were important for “conceptualizing the real world.” The researchers also recognized the importance of a database schema to have the ability to represent generalizations. In data modeling, the concept of generalization is associated with super-classes and subclasses [10]. During the generalization process, the differences between entities are minimized by identifying shared characteristics. The shared characteristics will compose the superclass. The original entities are now subclasses due to the non-shared characteristics that are present in each entity. Generalization has an important role in the PT Pattern (Figure 7).

5.2 New Approach: Polymorphic Pattern Formalization and Explanation

5.2.1 Polymorphic Table Entity (PTE)

The foundational entity of the PT Pattern is the *Polymorphic Table entity (PTE)*. It is a wrapper for the “table column” entities. The *PTE* is represented as an independent entity with green background (Figure 7). Although *PTEs* are primarily used to model subtypes or generalization categories that are present in traditional relational models, they can also be used to model the “root” entity (comparable to an xml parent node).

The *PTE* is a compact entity consisting of three attributes. The composite primary key is composed of two attributes, *tableID* and *recordID*. The *tableID* attribute uniquely distinguishes the polymorphic table from other polymorphic tables in the data model. The *recordID* attribute has dual purpose. The attribute visually correlates the *PTE* to its various related objects. The attribute is also intended to be an internal identifier that associates the *PTE* to a specific data record. The third attribute, *tablename*, holds the name of the polymorphic table (ie. Blog, PT.Blogs). The *PTE* is a header for a collection object. The entity, because of its designation as a header, cannot be a dependent entity. This rule is necessary in order for the model to support an embedded style [17] or reference style. It was earlier stated that the *PTE* was a wrapper for the “table columns”. The table column entities are called *Polymorphic Table Columns (PTCs)*.

5.2.2 Polymorphic Table Column (PTC)

The *Polymorphic Table Column (PTC)* contains metadata for the model and is similar to a table column definition in a relational data model. It is a child of the *PTE*. It is modeled as a super-type containing three attributes:

- *polymorphicTableName*
- *tableID*

- *recordID*

The *polymorphicTableName* stores the name of the column entity. The name is unique only within the scope of the *PTE*. The *tableID* and *recordID* attributes are inherited from the *PTE*. The generalization of the *PTC* is a complete generalization resulting in the formation of two subtypes: *Polymorphic Table Column Simple (PTCS)* and *Polymorphic Table Column Complex (PTCC)*.

5.2.3 Polymorphic Table Column Simple (PTCS)

The unique challenge of the aggregate-oriented nature [32] of document store NoSQL database necessitated the subtypes *PTCS* and *PTCC*. The *PTCS* is modeled by a dependent entity with a red background. The entity is used to represent a *simple column*. In the scope of the *PT* Pattern, a *simple column* is a column that contains only a single primitive value (ie. boolean, numeric, date, string, etc.). There are some data type exceptions such as binary data (in the case of MongoDB). The *PTCS* entity uses the *dataType* attribute to store the column's datatype. If the column references a column in a *Standalone Polymorphic Table* entity (discussed later in the paper), then the *referencedTableID* attribute stores the referenced table's ID. The *referencedPolymorphicTableColumnName* will store the *Standalone Polymorphic Table* entity's column name. This concept is similar to a foreign key in a relational model. The aforementioned attributes can be omitted from the model if the column is not a foreign key. An examination of the *PTCS* reveals that there is place for to store the actual data value.

5.2.4 Polymorphic Table Column Value Simple (PTCVS)

The *PTCVS* is a child of the *PTCS*. It is represented by a dependent entity with a gray background whose primary key is entirely inherited from the *PTCS*. The only additional attribute in the entity is the *value* attribute. The *value* attribute is used to store the column value for a specific record identified by the *recordID* attribute. The data type of the value is determined by the parent *PTCS*.

5.2.5 Polymorphic Table Column Complex (PTCC)

The *PTCC* is represented by a dependent entity with a blue background. The *PTCC* entity is similar to the *PTCS* in that its primary key is entirely inherited from the *PTC* entity. But, this is where the similarity ends. The *PTCC* is distinguished from the *PTCS* in the fact that it provides a mechanism to establish an aggregate hierarchy. This is accomplished by using a recursive pattern to model the hierarchy. The hierarchy is constructed by populating *polymorphicParentColumn* attribute. It is important to note that the relationship is a nullable, non-identifying relationship. The nullable relationship allows the *PTCC* to be created without a hierarchy. The use of the *polymorphicParentColumn* attribute creates a *1:1* relationship between the parent and child columns. In order to create a *1:M* relationship, the *PolymorphicTableChildColumnBridge (PTCCB)* must be used. The *PTCCB* will be discussed later in greater detail.

5.2.6 Polymorphic Table Column Attribute (PTCA)

A comparison of the *PTCC* and *PTCS* entities reveals that the *PTCC* has no *dataType* attribute. Why is there no *datatype* attribute? The complex column concept needs to be revisited, and the following scenario must be examined in order to answer the question. Suppose fictitious *Company A* maintains customer addresses in a system. The existing business rules mandate that system must capture the following address information: street address, city, state, and postal code. It is clear that each data component of the address will have its own value and possibly different data types. In order to model the address, the *PT* model must be able to represent each data type of each component (column) of the address. The *PTCA* entity is introduced to facilitate the modeling of the data types of a complex column.

The *PTCA* is represented by a dependent child entity with an orange background. Its primary key is a composite key composed of the parent *PTCC*'s primary key in addition to the *attributeName* attribute. The *attributeName* attribute is used to store the name of a column that composes the *PTCC* and is unique to the scope of the *PTCC*. The *PTCA*'s *dataType* stores the expected data type of the column value. The *PTCA* reinforces the concept of aggregation by allowing the *PTCC* to be represented by one or more *PTCAs*. If the column references a column in another *PTE* then the *referencedTableID* attribute stores the referenced table's ID. The *referencedPolymorphicTableColumn-Name* will store the *PTE*'s column name. This concept is similar to a foreign key in a relational model. The aforementioned attributes can be omitted from the model if the column is not a foreign key.

5.2.7 Polymorphic Table Column Value Complex (PTCVC)

The *PTCVC* entity is used to store the column value of a *PTCA* entity. It is represented by a dependent entity with yellow background. The *PTCVC* is a child of the *PTCA* entity. Like the *PTCVS*, its primary key is entirely inherited from the parent entity.

5.2.8 Polymorphic Table Child Column Bridge (PTCCB)

Aggregate-oriented modeling scenarios can occur where the one parent entity limitation of the *PTCC* prevents the modeling of certain complex columns. The column types of a *PTCC*'s children fall into two categories: *homogeneous* and *heterogeneous*. If the column types are homogenous then all of the columns will be represented either as *PTCS* or *PTCC*, not both. Heterogeneous columns types are represented as either *PTCS* or *PTCC*. This is most noticeable when attempting to model a complex column that is composed of existing complex columns. The parent-child relationship in this case is aggregation (in the context UML) because the child's lifetime is not dependent upon the parent's. This relationship is different from the relationship that is modeled by the *PTCC*. The parent-child relationship in the *PTCC* describes a composition. In a composition, the child entity's lifetime is the same as the parent entity's lifetime. A new entity must be introduced to meet the challenge of the modeling the aggregate column relationship.

The *PTCCB* is used to model the aggregate relationship of the complex column. It is a flexible entity that supports an unlimited number of child columns. The *PTCCB* is represented by a dependent entity with a dark blue background. Its primary key is a composite key consisting of the primary keys of the parent *PTCC* and the *polymorphicChildColumn*. The *polymorphicChildColumn* attribute contains the name of the column that helps to form the *PTCC*. A careful look at the *PT* pattern shows that a *polymorphicChildColumn* can be either a *PTCC* or a *PTCS*.

5.2.9 Polymorphic Table to Polymorphic Table Bridge (PTB) and Owner Container (OC)

The flexibility of the *PT* pattern allows for the aggregation of Polymorphic Table entities. Since the *Polymorphic Table* entities are independent, it is a true aggregation as opposed to composition. In order to represent the aggregation, two new structures must be introduced. The *Polymorphic Table to Polymorphic Table Bridge (PTB)* entity and the *OwnerContainer (OC)* entity. Both are represented as dependent entities with a white background.

The *OC* entity is a dependent entity whose parent is a *PTE*. The primary purpose of the entity is to create a logical grouping or hierarchy. Similar container or containment concepts have been researched in [18, 33, 40] The *OC*'s composite primary key consists of the following attributes: *ownerContainerName*, *tableID*, and *recordID*. The *ownerContainerName* attribute stores the name of the aggregation. The *tableID* and *recordID* attributes are inherited from the parent entity. The *OC* entity contains an additional, nullable attribute named *parentOwnerContainer*. The attribute allows for the creation of a container hierarchy. The *OC* entity participates in the *PTB* entity.

5.2.10 Standalone Polymorphic Table Entity (SPTE)

It is necessary to introduce the *SPTE* before proceeding with the application of the *PT* pattern. The *SPTE* is a special type of *PTE*. It has the same characteristics as a *PTE*, but it also has usage restrictions. The *SPTE* cannot participate in relationships with *OCs*. Lastly, the *SPTE* cannot participate in relationships with a *PTB*. The purpose of the *SPTE* is to model standalone entities such as lookups. The *SPTE* usage scenario will be explored later in the paper.

CHAPTER 6

MODELING APPLICATION WITH THE POLYMORPHIC TABLE PATTERN BY EXAMPLE

6.1 Relational Model (RM) Example

The Colorado Department of Transportation's project change process has been selected for the real-world use case. The following relational model (Figure 8) has been derived from project templates and guidelines obtained from the department's official website (<http://www.coloradodot.info>). A project contains several documents in this use case. Each document is classified as one of the following: contract change order, contract change order memo, or drawing.

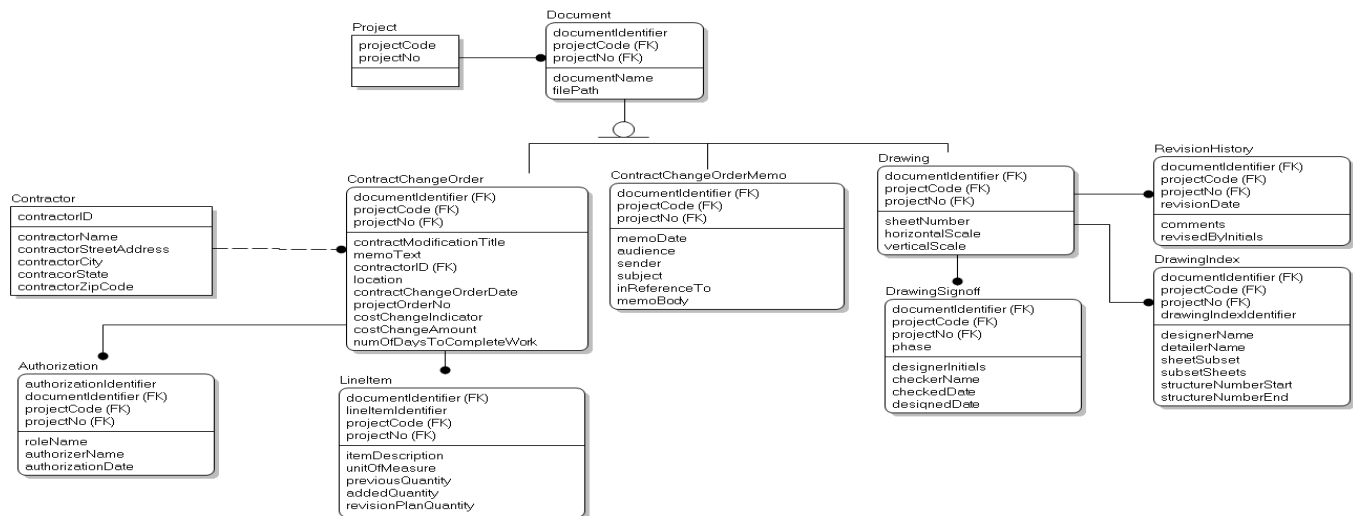

Figure 8. Relational Model Exemplar

6.2 RM to Logical Model Transformation – Parent Entity

The transformation of the relational model begins with the identification of parent entities. Entities must meet the following two requirements to be designated as parent entities. The first requirement is that entity is independent. The entities that meet the initial requirement are *Project* and *Contractor*. The second requirement is that the entity participates in an identifying relationship. The only entity that meets the second requirement is the *Project* entity. Therefore, *Project* becomes a parent entity. The parent entity must now be disassembled into the following entities: *PTE*, *PTCS*, and *PTCVS*.

The creation of the *PTE* begins with its naming. The naming convention for the entity is the name of the parent entity prefixed with PT_. The name of the PT entity becomes PT_Project. The entity's attribute population is the next activity. The PTE's primary key attribute names (tableID and recordID) are retained from the PT Pattern (for the sake of simplicity). The tableName attribute is replaced by the camel-cased name of the parent entity. In this particular case, tableName becomes project.

The original attributes of the relational model's *Project* entity must now be modeled. This is accomplished by transforming each attribute into a *PTCS* entity. The process begins by creating the *PTCS* as a dependent of the *PT_Project* entity. Part of the *PTCS*'s composite key is inherited from the *PT_Project* as a result of the dependent relationship. The naming convention for the entity is the *PTCS_originalParentEntityName_attribute*. The resulting name for the new *PTCS* entity is *PTCS_Project_ProjectCode*.

Next, the *projectCode* attribute is selected from the original *Project* entity and becomes the part of the primary key of the *PTCS* entity. A careful review of the *PTCS* entity reveals that a *datatype* attribute exists. For this exercise, *projectCode* will be of type string. The data modeler may now wonder, "How are primary keys specified in the PT pattern?" The primary key is specified with a textbox containing the phrase, *Primary Key*, positioned above the relationship. Since *projectCode* is not a "foreign key" the *referencedTableID* and *referenced-PolymorphicTableColumnName* do not appear in the *PTCS* entity.

The *projectCode* attribute has now been declared, and now a *PTCVS* must be modeled. The naming convention of the entity is *PTCVS_originalParentEntityName_attribute*. The *PTCVS*'s resulting name is *PTCVS_Project_ProjectCode*. The entity's primary key is entirely inherited from its parent *PTCS*. The remaining attribute is the value attribute, which is populated with a placeholder by the same name.

The previous transformation steps are repeated for each remaining attribute of the original *Project* entity. Next the dependent, super-type *Document* entity and its corresponding subtypes will be modeled in the style of the *PT* pattern.

6.3 RM to Logical Model Transformation – Super-type and Subtype

In this section, the *Document* entity and its related subtypes will be transformed into *PTEs*. The relational model (Figure 8) shows the *Document* entity as a dependent entity. The dependent relationship of the entity and its parent presents a conflict with the independent nature of the *PTE*. The conflict is resolved by refactoring the *Document* entity. The refactoring is accomplished by demoting the *projectCode* and *projectNo* attributes (from the *Project* entity). The refactoring causes the relationship between the *Project* and *Document* entities to become a non-identifying relationship. The *Document* entity becomes independent due to the non-identifying relationship. At this time it is important to note that the demoted attributes will participate in a unique constraint during physical modeling. The refactored *Document* entity is depicted in Figure 9.

The data modeler may be tempted at this point to model the *Document* entity by following the same prescribed steps performed in the *Project* to *PT_Project* transformation. To follow the same steps would be erroneous because of the manner in which the *PT* pattern handles super-types and subtypes. In the *PT* pattern, the super-type will not actually be modeled. Instead, the super-type and its subtypes will be involved two more rounds of structural refactoring. A structural refactoring process based on the *Move Column* refactoring technique [1] is used in the second round. All non-key attributes will be moved to the subtypes. In this particular example, the *documentName*, and *filePath* attributes of the *Document* entity are moved to each subtype. The final refactoring implements adapted versions of the *Merge Table* and *Drop Table* structural

refactoring techniques [1]. The *Document* entity is merged with its subtypes during the final round of refactoring. The *Document* entity is then dropped from the model. The former subtypes are promoted to “normal” entity status and participate in non-identifying relationships with the *Project* entity. The foreign key to the *Project* entity will later participate in a unique constraint in the physical model. The final result of the refactoring is pictured in Figure 9.

The former subtypes will now be transformed into *PTEs*. The creation of each *PTE* begins with its name. The established *PTE* naming convention yields the following names:

- PT_ContractChangeOrder
- PT_ContractChangeOrderMemo
- PT_Drawing.

The attributes for each new *PTE* will now be populated. Each *PTE*'s primary key attribute names (*tableID* and *recordID*) are retained from the PT pattern. The *tableName* attributes are replaced by the camel-cased names of the corresponding parent entities. The process for modeling each original entity's attributes is same remains the same as prescribed earlier.

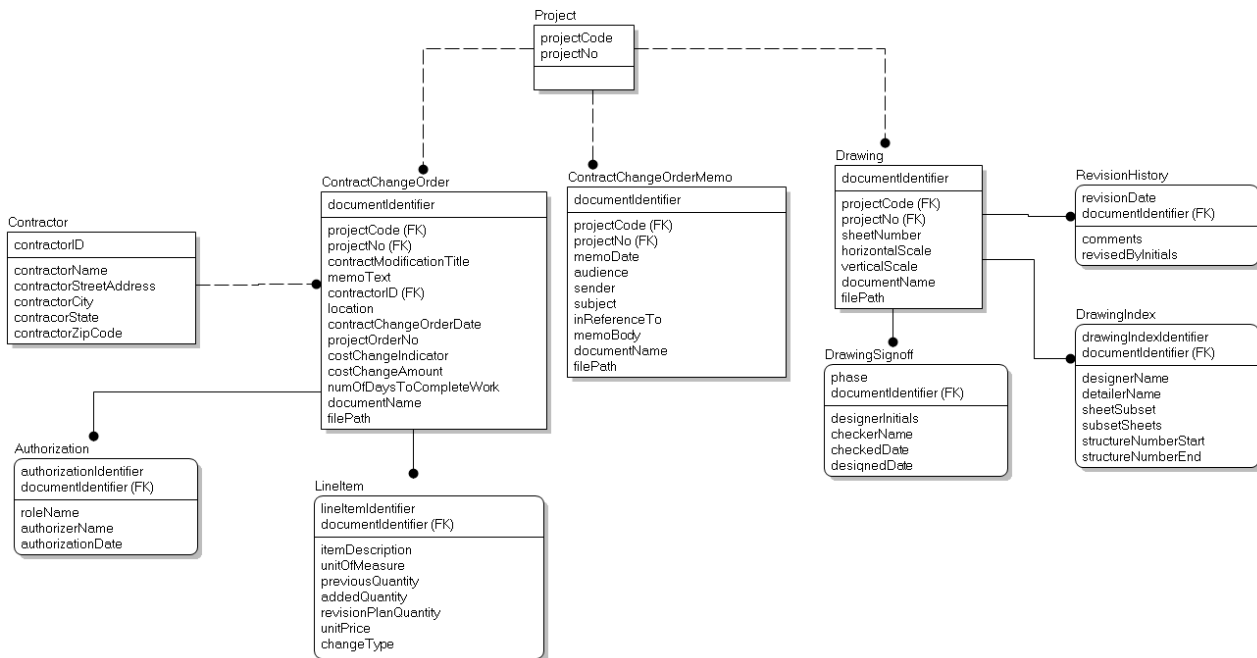

Figure 9 – Relational exemplar post refactoring

6.4 RM to Logical Model Transformation – PTE’s Dependent Entity

Although the *PTEs* have modeled, the relational model transformation is not yet complete. There are still remaining entities to be modeled. The remaining entities can be classified into two categories: dependent and independent. The transformation of the dependent entities will be addressed first. In order to model the dependent entities, the concept of *embedding* [1] will be implemented. Embedding will be used to nest a dependent entity within its parent entity. It is similar in concept to the nesting of nodes within an xml document. For example, a car may be modeled by an XML document (Figure 10). A review of the document reveals the vin and features nodes are embedded with the car parent node. The PT pattern performs a similar style of modeling through of the use of the *Embeds* operator [17] and the *PTCC* entity.

```
<car>
  <vin>123456789</vin>
  <features>
    <feature>all wheel drive</feature>
    <feature>air conditioning</feature>
  </features>
</car>
```

Figure 10 Car XML

A review of the relational model (Figure 9) shows that the *Drawing* and *ContractChangeOrder* entities have dependent entities. The *Drawing* entity and its dependent entities are arbitrarily selected to be modeled first. The *Drawing* entity has the following dependents:

- RevisionHistory
- DrawingSignoff
- DrawingIndex

A dependent entity’s PTCC transformation begins with naming of the newly created PTCC entity. The established PTCC naming convention yields the following names (derived from the dependent entities):

- PTCC_Drawing_RevisionHistory
- PTCC_Drawing_DrawingSignoff
- PTCC_Drawing_DrawingIndex

Next, the PTCC’s attributes are populated. The *polymorphic-TableName* attribute is replaced by the camel-cased name of the attribute from the original dependent entity. The remaining part of the primary key

attribute (tableID and recordID) is retained from the *PT* Pattern and inherited from the parent *PTE*. Lastly, the *EMBEDS* operator is placed on each relation between the *PTE* and the *PTCC*.

At this point in the modeling effort, the newly modeled *Drawing PTCCs* only represent the “shell” of the polymorphic columns. The remaining attributes of each *PTCC* must now be modeled. This is accomplished by implementing *PTCA* entities. Each *PTCA* will represent an attribute from the corresponding dependent entity in the relational model. The *DrawingSignoff* will now be transformed using the following steps. Attribute selection is the first step in the transformation process. Each attribute is selected in turn, and a *PTCA* is created for each. For example, a new *PTCA* is created for the *phase* attribute (from the *DrawingSignoff* entity in the relational model). The naming convention for the *PTCA* entity is *PTCA_originalParentEntityName_attribute*. The resulting name for the *phase* attribute is *PTCA_Drawing_Phase*. Next, the camel-cased *phase* attribute is created in the newly named *PTCA*. The attribute becomes first half of the composited primary key. The remaining half of the primary key is inherited from the parent *PTCC* entity. The *PTCA* is not complete until the data type of the attribute is placed in the entity. In this case, *phase* will be represented by the *string* data type. Lastly, the relationship between the *PTCA* and *PTCC* will be notated with the Primary Key indicator if the attribute is a primary key.

The *phase* attribute is now modeled, and *PTCVC* entity must be created. The name of the entity is derived in a two-step process. First, the parent *PTCC*'s name is copied, and the *PTCC* prefix is replaced with *PTCA*. Second, the name is appended with *_attribute*. The resulting name for the *phase* attribute is *PTCVC_Drawing_DrawingSignoff_Phase*. The entity's primary key is entirely inherited from its *PTCC* parent. The remaining attribute is the value attribute, which is populated with a placeholder by the same name. The process is repeated for each attribute in the *DrawingSignoff* entity. The *DrawingIndex* and *RevisionHistory* *PTCCs* are modeled in similar fashion.

The *ContractChangeOrder* entity is also modeled in a similar fashion to the *Drawing* entity, but with an exception. A careful review of the model reveals that the *PTCS_ContractChangeOrder_ContractorID* entity contains values for the attributes *referencedTableID* and *referencedPolymorphic-TableColumnName*. The attributes are populated due to the *ContractChangeOrder* entity's involvement in a non-identifying relationship with the *Contractor* entity. The *Contractor* entity behaves as a lookup entity in this scenario, and is modeled accordingly as a *SPT*. The naming convention for the *SPT* is *SPT_originalEntityName*. The resulting entity name is *SPT_Contractor*. The *referencedTableID* attribute is populated with name of the *SPT*, *SPT_Contract*. The *referencedPolymorphicTableColumnName* attribute is populated with *SPT_Contract* column name that will be referenced. The format *SPT.columnName* for the *contractorID* result in the following attribute name, *SPT_Contract.contractorID*. The format was selected to avoid name collisions in the entity.

6.5 RM to Logical Transformation – PTB and OC

The *PT* pattern gives the modeler the ability to represent hierarchies with relative ease. In the relational model example that we are transforming, a project can be associated with multiple types of documents (*ContractChangeOrder*, *Drawing*, and *ContractChangeOrderMemo*). The hierarchical representation is

accomplished using the following steps. First, the *OC* is created and named using the following naming convention, *OC_containerName*. The resulting entity name is *OC_Documents*. The *containerName* attribute is replaced with the camel-cased name of the container. In this scenario, *documents* becomes the container name. The *parentOwnerContainer* attribute is removed from the entity because the *OC_Documents* entity is not a child of another *OC*. The *OC* entity is now ready to be associated with parent *PT* entity, *PT_Project*, using an identifying relationship. Next, the *PTB* entity needs to be created.

The *PTB* creation begins the child *PT* selection. The *Project-ContractChangeOrderMemo* relationship will be modeled for demonstration. The naming convention for the *PTB* is *PTB_containerName_parentPT_childPT*. The *PTB* entity's name becomes *PTB_Documents_Project_ContractChangeOrderMemo*. Identifying relationships are used to establish the *PTB* entity as a child of both the *OC_Documents* and *PT_Project* entities. The *PT_Drawing* and *PT_ContractChangeOrder* entities are associated with the *OC_Documents* entity using the *PTB* creation steps.

6.6 Physical Modeling Application

The derivation of the physical model from the previously established logical model is relatively trivial. The physical model differs from its logical counterpart in the following areas:

- Table renaming
- *Polymorphic Table* key specification
- SQL data type specification
- Detailed primary key specification
- Index identification
- Referenced attribute identification

6.6.1 Table Renaming

The *PT* entity contains the *tableName* attribute. The attribute is populated with the camel-cased name of the *PT* entity during the logical modeling process. The attribute value is replaced with the name of the *PT* entity during the physical model transformation.

6.6.2 Polymorphic Table Key Specification

The data types for *PT* entity's composite primary key needs to be specified. But, before this can take place there is an attribute must be renamed. The *recordID* is renamed to *_id*. This renaming is used to

emphasize the fact that the document store database (MongoBD in this context) uses the *_id* to uniquely identify documents (records) within a collection (table). After the renaming, a rectangle annotation with a yellow background is created for each field of the key. The annotation's text is of the format *KEY: fieldName, DT: dataType*. The resulting annotations for the *PT*'s are:

- KEY: tableID, DT: VARCHAR(100)
- KEY: _id, DT: VARCHAR(100)

The annotations are placed either on the top or the left-side of the *PT* entity. Figure 11 shows an example of the annotations.

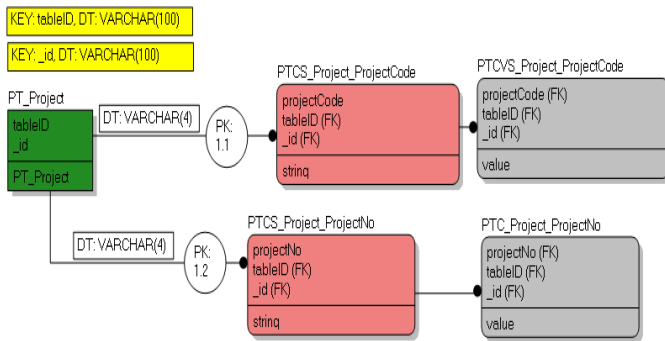

Figure 11 – PTE Key specification

6.6.3 SQL Data Type Specification

Each attribute within the physical model must be assigned a general SQL Data Type. The data type is notated with a rectangle annotation with the following format, *DT: dataType*. The annotation is positioned on the parental side of relationship. The data type is declared using the standard SQL data type declarations.

Table 1 - Examples of supported SQL data types

Data Type	Physical Model Annotation
CHARACTER(n)	DT: CHARACTER(n)
CHAR(n)	DT: CHAR(n)

VARCHAR(n)	DT: VARCHAR(n)
INTEGER	DT: INTEGER
DECIMAL(p,s)	DT: DECIMAL(p,s)
NUMERIC(p,s)	DT: NUMERIC(p,s)
DATE	DT: DATE
TIMESTAMP	DT: TIMESTAMP

6.6.4 Detailed Primary Key Specification

The manner in which the physical model specifies primary keys differs from the logical model. In the logical model, the primary keys are simply labeled with *Primary Key* inside a rectangular annotation. Each key of a composite primary key is labeled with the annotation. The annotation is positioned on the “child side” of relationship. The physical model enhances the primary key notation by changing the annotation to a circle and using the following the notation format, *PK: n.n*. The *n.n* format is very useful for composite primary key annotations (Figure 11). For example, a composite primary key field would have the annotations *PK 1.1* and *PK 1.2*.

6.6.5 Detailed Index Specification

The physical model uses circular annotations to denote indexes. There are three types of indexes denoted in this manner: *primary key*, *unique*, and *index*. Primary key indexes are covered in the previous section. Unique indices are labeled with the format *UK: n.n*. The “ordinary” indices are labeled with the format *IDX: n.n* (Figure 12). Each annotation is positioned on the “child side” of relationship.

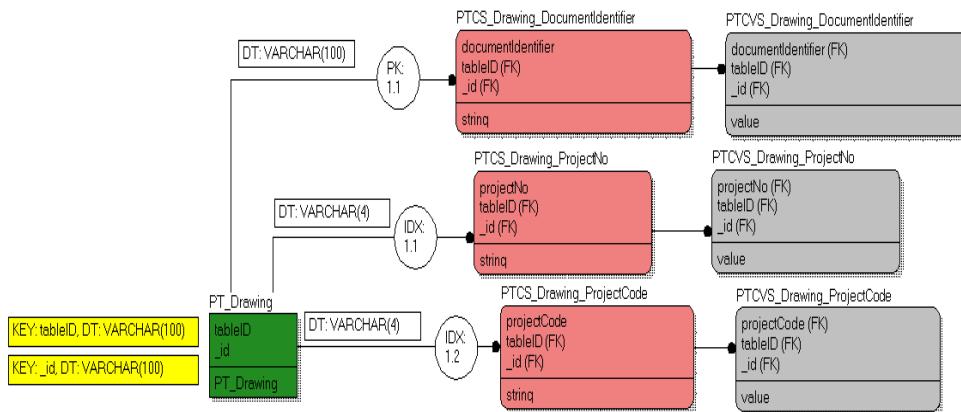

Figure 12 - Index Specification

6.6.6 Referenced Attribute Identification

Referenced attributes are similar to foreign keys in the relational model. In the *PT* pattern, the referenced key is a key that references a “record” in a *SPT* entity. This attribute is specified using a circular annotation. The annotation is positioned on the “child side” of relationship. The annotation’s text uses the following format, *REF n.n*.

CHAPTER 7

PHYSICAL SOFTWARE IMPLEMENTATION PATTERN META-SCHEMA

7.1 Meta-schema Approach Explanation

The MongoDB database system stores its document in BSON (Binary JSON) format [23]. JSON is a human readable, flexible data interchange format. It is built upon two structures: key-value pair and ordered list of values. JSON supports the following value data types: *string*, *number*, *boolean*, *object*, and *array*. There are no mechanisms to specify required *key-value* pairs, arrays, or objects. The lack of the aforementioned mechanisms presents a problem for our MongoDB implementation. We decided to implement the following XML Schema language inspired constructs to address our issues.

- Element specification

Our approach introduces the *required* attribute to mandate the appearance of the columns that were represented by either *Polymorphic Table Column Simple* or *Polymorphic Table Column Complex* entities. The *required* attribute is also used to specify required parent column relationships and child table relationships.

- Child element specification
- Occurrence indicators

The *minOccurrences* and *maxOccurrences* are implemented in our model to specify the number of occurrences of element in our document.

- Data type specification

Our meta-schema will implement the constructs in a special series of MongoDB collections. We have organized our meta-schema into the following collections:

- schema.tables
- schema.table.global.columns
- schema.table.columns.simple
- schema.tables.columns.complex
- schema.tables.containers

There are a set of based key-value pairs that required for document in each collection. The required key-value pairs are *_id* and *_idDataType*. The *_id* key is a MongoDB key [13] which stores the unique (primary) key for the document in the collection. The *_id* can be any data type. Its data type is explicitly declared by the *_idDataType*

key. Each collection is explained in the following sections. Also, detailed descriptions of the attributes meta-schema attributes are available in Appendix A.

7.1.1 Schema.table.global.columns Collection

The *schema.table.global.columns* collection contains the metadata for common “columns” that can be applied to any *Polymorphic Table Entity (PTE)* in the data model. For example, the MongoDB *_id* key can be of any data type. If the modeler wished to restrict the data type for each *PTE*'s *_id*, then the column and its type would be declared in this collection. The restriction would apply to any *PTE* in the *schema.tables* collection whose *useGlobalColumns* key equal true.

```
{
  "globalColumnName": "_id",
  "globalColumnNameDataType": "VARCHAR(100)"
}
```

Figure 13 – Schema.table.global.columns sample

7.1.2 Schema.tables Collection

The *schema.tables* collection contains the meta-schema for each *PTE* in the data model. It is the primary collection for our meta-schema approach. An example document is shown in below.

```
{
  "_id": "PT_Project",
  "_idDataType": "VARCHAR(100)",
  "tableName": "PT_Project",
  "tableNameDataType": "VARCHAR(50)",
  "useGlobalColumns": true
}
```

Figure 14 – Schema.tables sample

7.1.3 Schema.table.containers Collection

The *schema.table.containers* collection contains the meta-schema which facilitates the *PTE* aggregate hierarchies that are present in the logical model (represented with *PTB* and *OC* entities). An example document is shown below.

```

{
  "_id": "OC_Documents",
  "_idIDataType": "VARCHAR(100)",
  "containerID": "OC_Documents",
  "containerIDDataTypes": "VARCHAR(100)",
  "required": false,
  "parentContainerID": "parentContainer",
  "parentContainerIDDataTypes": "VARCHAR(100)",
  "parentContainerRequired": false,
  "parentTableID": "PT_Project",
  "parentTableIDDataTypes": "VARCHAR(100)",
  "childTables": {
    "required": false,
    "minOccurrences": "1",
    "maxOccurrences": "UNBOUNDED",
    "childTableID": "childTable",
    "childTableIDDataTypes": "VARCHAR(100)"
  }
}

```

Figure 15 – Schema.tables.containers sample

7.1.4 Schema.table.columns.simple Collection

The *schema.table.columns.simple* collection contains meta-schema which represents the *PTCS* entity and its related *PTCVS* entity. An example document is shown below.

```

{
  "_id": "PTCS_Project_ProjectCode",
  "_idIDataType": "VARCHAR(100)",
  "tableID": "PT_Project",
  "tableIDDataTypes": "VARCHAR(100)",
  "columnName": "PTCS_Project_ProjectCode",
  "columnNameIDataTypes": "VARCHAR(100)",
  "columnValueIDataTypes": "VARCHAR(4)",
  "required": true,
  "referencedTableID": "referencedTableID",
  "referencedTableIDDataTypes": "VARCHAR(100)",
  "referencedColumnName": "referencedColumnName",
  "referencedColumnNameIDataTypes": "VARCHAR(100)",
  "referencedColumnRequired": false
}

```

Figure 16 – Schema.table.columns.simple sample

7.1.5 Schema.table.columns.complex Collection

The *schema.table.columns.complex* collection contains the meta-schema which represents the *PTCC* entity and its related *PTCVC* entity. An example is shown below.

```

{
  "_id": "PTCC_Drawing_DrawingSignoff",
  "_idDataType": "VARCHAR(100)",
  "tableID": "PT_Drawing",
  "tableIDDataType": "VARCHAR(100)",
  "columnName": "PTCC_Drawing_DrawingSignoff",
  "columnNameDataType": "VARCHAR(100)",
  "required": false,
  "minOccurrences": "0",
  "maxOccurrences": "UNBOUNDED",
  "parentColumn": {
    "required": false,
    "parentColumnID": "parentColumnID",
    "parentColumnIDDataType": "VARCHAR(100)"
  },
  "columnAttributes": [
    {
      "codeEnforcedPrimaryKey": true,
      "columnAttributeName": "phase",
      "columnAttributeNameDataType": "VARCHAR(100)",
      "columnAttributeDataType": "VARCHAR(20)",
      "columnAttributeRequired": true,
      "referencedTableID": "referencedTableID",
      "referencedTableIDDataType": "VARCHAR(100)",
      "referencedColumnName": "referencedColumnName",
      "referencedColumnNameDataType": "VARCHAR(100)",
      "referencedColumnRequired": false
    }
  ],
  "childComplexColumns": {
    "required": false,
    "minOccurrences": "0",
    "maxOccurrences": "UNBOUNDED",
    "childComplexColumnID": "childColumnID",
    "childComplexColumnIDDataType": "VARCHAR(100)"
  }
}

```

Figure 17- Schema.table.columns.complex sample

CHAPTER 8

VALIDATION OF THE APPROACH

8.1 Model Requirements Implementation

Earlier in our paper specified data modeling requirements which we deemed necessary for a successful implementation of a NoSQL modeling solution. The requirements were separated into two categories: *general NoSQL data model requirements* and *data modeling constructs*. The following section discusses how our modeling effort met the data modeling requirements.

8.1.1 General NoSQL Data Model Requirements

- NoSQL Document Store Implementation Agnosticism

Our modeling technique did not cater to any particular document store NoSQL database implementation. We avoided the potential implementation-specific data type specification issues by allowing the *dataType* attribute of both the *Polymorphic Table Column Attribute (PTCA)* and *Polymorphic Table Column Simple (PTCS)* to be a string value. This allows the data modeler to specify any data type that is necessary to properly express the intended value in the model.

- Formal Foundations

The *Polymorphic Table* pattern established a set of standard entities, rules for entity creation and identification, and relationship.

- Data Description

The physical model introduced rectangle data type annotations that were used to specify the base SQL types that represent the data stored in the *PTCA*, *PTCS*, and *PTE* entities. Circular annotations were used to specify primary, unique, and reference keys. The model supported irregular and semi-structured data with the introduction of *required* meta-schema attribute in the physical model.

- Hierarchical Representation

The *Polymorphic Table* pattern introduced a number of different constructs to satisfy the *hierarchical representation* requirement. The *EMBEDS* annotation was introduced to specify the nesting of the *Polymorphic Table Column Attribute* entity within the *Polymorphic Table Column Complex* entity. The *Owner Container* entity was created to implement *Polymorphic Table* entity hierarchies.

- Graphical Representation

IDEF1x standard entities were used as the base for our entities and relationships. We distinguished many of our entities from one another through the use of background color. Relationship lines were not enhanced. Instead, we added annotations to denote *embeds* and *reference* relationships. Annotations were also used to graphically represent primary keys, unique keys, data types.

8.1.2 Modeling Constructs

- Entity Identification

Our proposal inherited base entity identification constructs from IDEF1x. We created the following nomenclature to enhance entity identification and distinguish entities from the normal IDEF1x entities.

- PTE, PT_<entity name>
- SPTE, SPT_<entity name>
- PTCS, PTCS_<parent entity>_<attribute>
- PTCC, PTCC_<parent entity>_<column>
- PTCA, PTCA_<parent entity>_<column>_<attribute>
- PTCVS, PTCVS_<parent PTE>_<attribute>
- PTCVC, PTCVC_<parent PTE>_<column>
- PTB, PTB_<parent PTE>_<child PTE>
- OC, OC_<container name>

- Identifying Property

Circular annotations containing the text *PK n.n*, were used to identify primary keys in the model. The circular annotations were placed on the child side of the relationship. Multi-part primary keys were allowed in the modeled. They were identified by populated the *n.n* with the appropriate integer values. For example, primary key with two values would have the following annotations: PK 1.1 and PK 1.2.

- Unique Property Constraint

Circular annotations containing the text *UK*, were placed on the relationship lines between the PTCC child and the parent PTE of the physical model. The circular annotations were placed on the child side of the relationship.

- Required/Optional Property

Square annotations containing *R* (required) and *O* (optional) were used to specify whether or not a *Polymorphic Table Column* (simple or complex) or an attribute of a *Polymorphic Table Column Complex* entity are required. The notations were placed on the relationship line between the parent and child entities.

- Data Type Property

Rectangular annotations containing specific SQL data type specifications were used in our model. The size (when applicable), and precision (when applicable) are notated within the rectangle annotation.

- Complex Objects

The data model provided the following entities for the construction of complex objects:

- Polymorphic Table Entity
- Polymorphic Table Column Simple
- Polymorphic Table Column Complex
- Polymorphic Table Column Attribute
- Polymorphic Table Column Value Simple
- Polymorphic Table Column Value Complex
- Polymorphic Table To Polymorphic Table Bridge
- Owner Container

For example, a Polymorphic Table Column Complex entity employs the Polymorphic Table Column Attribute and Polymorphic Table Column Value Complex entities to represent a sub-document.

- Cardinality

The data model inherited the IDEF1x cardinality constructs. Unless otherwise notated the relationships are implied to be *zero, one, or many*.

8.2 Meta-Schema Enforced Documents (Experimental Data)

8.2.1 PT_Project Document Validation

We have proven, in the previous section, that our data model specifications were met. However we have addressed the end result of a meta-schema enforced document. It is important that we will not proposed algorithms for performing the validation. This is area of future research. But, what we do present is a series of manually created, meta-schema enforced documents.

We created a *PT_Project* document (Figure 11) and manually validated it against the following meta-schema shown in Figure 18, Figure 19, and Figure 21.

```
{
  "_id": "Project-1",
  "tableID": "PT_Project",
  "PTCS_Project_ProjectCode": "PRJ1",
  "PTCS_Project_ProjectNo": "0001",
  "OC_Documents": {
    "childTables": [
      {
        "childTable": "ChangeOrder-1"
      },
      {
        "childTable": "DRAW-1"
      }
    ]
  }
}
```

Figure 18 – PT_Project document

- schema.tables

```
{
  "_id" : "PT_Project",
  "_idDataType" : "VARCHAR(100)",
  "tableName" : "PT_Project",
  "tableNameDataType" : "VARCHAR(50)",
  "useGlobalColumns": true
}
```

Figure 19 – PT_Project meta-schema

The document passes this validation step because it meets the following the requirements:

- The *_id* key value meets the data type specification of `varchar(100)`. The data type was specified in the `schema.table.global.columns` collection.
 - The *tableName* key value is populated with an existing `tableName` that is specified in the `schema.tables` collection
- `schema.table.containers`

```
{
  "_id": "OC_Documents",
  "_idTDataType": "VARCHAR(100)",
  "containerID": "OC_Documents",
  "containerIDDataType": "VARCHAR(100)",
  "required": false,
  "parentContainerID": "parentContainer",
  "parentContainerIDDataType": "VARCHAR(100)",
  "parentContainerRequired": false,
  "parentTableID": "PT_Project",
  "parentTableIDDataType": "VARCHAR(100)",
  "childTables": {
    "required": false,
    "minOccurrences": "1",
    "maxOccurrences": "UNBOUNDED",
    "childTableID": "childTable",
    "childTableIDDataType": "VARCHAR(100)"
  }
}
```

Figure 20 – Container document

The *PT_Project* document's *OC_Document* key is the *_id* of a container document that is specified in the containers meta-schema collection. The container is optional (as indicated by its *required* attribute). The document passes this validation step because it meets the following requirements:

- The *OC_Document* is the *_id* of an existing container
 - The *PT_Project* document's *tableID* value matches the *OC_Document*'s *parentTableID* value. This signifies that the container actually belongs to the *PT_Project* documents.
 - The *childTables* key has at least one *childTable* key-value pair (as specified by the *OC_Document* meta-schema).
- `schema.table.columns.simple`

All of the PT_Project documents “columns” are based on PTCS entities. Therefore all of its columns will be validated against the schema.table.columns.simple meta-schema for tableID = *PT_Project*. The document passes validation at this step for the following reasons:

- The *PTCS_Project_ProjectCode* key of the PT_Project document has the value *PRJ1* which meets the requirement column data type constraint of *VARCHAR(4)*. The inclusion of the key also fulfills the *required* designation.
- The *PTCS_Project_ProjectNo* key of the PT_Project document has the value *0001* which meets the requirement column data type constraint of *VARCHAR(4)*. The inclusion of the key also fulfills the *required* designation.

```
{
  "_id": "PTCS_Project_ProjectCode",
  "_idDataType": "VARCHAR(100)",
  "tableID": "PT_Project",
  "tableIDDataType": "VARCHAR(100)",
  "columnName": "PTCS_Project_ProjectCode",
  "columnNameDataType": "VARCHAR(100)",
  "columnValueDataType" : "VARCHAR(4)",
  "required": true,
  "referencedTableID": "referencedTableID",
  "referencedTableIDDataType": "VARCHAR(100)",
  "referencedColumnName": "referencedColumnName",
  "referencedColumnNameDataType": "VARCHAR(100)",
  "referencedColumnRequired": false
},
{
  "_id": "PTCS_Project_ProjectNo",
  "_idDataType": "VARCHAR(100)",
  "tableID": "PT_Project",
  "tableIDDataType": "VARCHAR(100)",
  "columnName": "PTCS_Project_ProjectNo",
  "columnNameDataType": "VARCHAR(100)",
  "columnValueDataType" : "VARCHAR(4)",
  "required": true,
  "referencedTableID": "referencedTableID",
  "referencedTableIDDataType": "VARCHAR(100)",
  "referencedColumnName": "referencedColumnName",
  "referencedColumnNameDataType": "VARCHAR(100)",
  "referencedColumnRequired": false
}
```

Figure 21 – PT_Project PTCS meta-schema

8.2.2 PT_ContractChangeOrder Document Validation

We created a *PT_ContractChangeOrder* document (Figure 16) and manually validated it against the following meta-schema:

```
{
  "_id": "ChangeOrder-1",
  "PTCS_ContractChangeOrder_DocumentIdentifier": "ChangeOrder-1"
  "PTCS_ContractChangeOrder_DocumentName": "ChangeOrder1.pdf",
  "PTCS_ContractChangeOrder_FilePath": "\\changeorder",
  "PTCS_ContractChangeOrder_ProjectCode": "PRJ1",
  "PTCS_ContractChangeOrder_ProjectNo": "0001",
  "PTCS_ContractChangeOrder_ContractModificationTitle": "Fence",
  "PTCS_ContractChangeOrder_MemoText": "Modified",
  "PTCS_ContractChangeOrder_ContractorID": 1,
  "PTCS_ContractChangeOrder_Location": "Route 66-South",
  "PTCS_ContractChangeOrder_ChangeOrderDate": "9/30/2002",
  "PTCS_ContractChangeOrder_ProjectOrderNo": "NH 77-077",
  "PTCS_ContractChangeOrder_CostChangeIndicator": "A",
  "PTCS_ContractChangeOrder_CostChangeAmount": 3000.00,
  "PTCS_ContractChangeOrder_NumOfDaysToCompleteWork": 4,
  "PTCC_ContractChangeOrder_ContractChangeOrderAuthorization": {
    "columnAttributes": [
      {
        "authorizationIdentifier": "AUTH-1",
        "roleName": "FWHA Operations Engineer",
        "authorizerName": "Bill R Pepper",
        "authorizationDate": "10/1/2002"
      }
    ]
  },
  "PTCC_ContractChangeOrder_ContractChangeOrderLineItem": {
    "columnAttributes": [
      {
        "lineItemIdentifier": "LINEITEM-1",
        "itemDescription": "607 Fence Comb Wire w/Metail Posts",
        "unitOfMeasure": "LF",
        "previousQuantity": 0.00,
        "addedQuantity": 500.00,
        "revisionPlanQuantity": 500.00,
        "unitPrice": 6.00,
        "changeType": "A"
      }
    ]
  }
}
```

Figure 22 – PT_ContractChangeOrder document

- schema.tables

```
{
  "_id": "PT_ContractChangeOrder",
  "_idDataType": "VARCHAR(100)",
  "tableName": "PT_ContractChangeOrder",
  "tableNameDataType": "VARCHAR(50)",
  "useGlobalColumns": true
}
```

Figure 23 – PT_ContractChangeOrder meta-schema

The document passes this validation step because it meets the following the requirements:

- The *_id* key value meets the data type specification of varchar(100). The data type was specified in the schema.table.global.columns collection.
 - The *tableName* key value is populated with an existing tableName that is specified in the schema.tables collection
- schema.table.columns.simple

The document passes validation against this schema collection for the following reasons:

- Each required *PTCS column* in the *PT_ContractChangeOrder* document is present and populated according the column meta-schema.
 - Each *PTCS* column value's data type is the same as that which is specified in the meta-schema.
- schema.table.columns.complex

The document passes validation against this schema collection as well for the following reasons:

- Each of the complex columns in the document met the minimum occurrence indicator. The columns did not exceed the max occurrence indicator.
- Each child document of the complex column contained a unique key value. For example, there is only one *lineItemIdentifier* with the value LINEITEM-1.

CHAPTER 9

COMPARATIVE ADVANTAGES

9.1 Required Skillset – IDEF1x

The preservation and application of the relational data modeler's current skillset is one of our goals for the *Polymorphic Table Modeling* pattern. We selected the IDEF1X modeling language because it is recognized as a standard in relational data modeling. Other features of IDEF1X's which influenced our decisions are:

- IDEF1x is a coherent language [25]
- IDEF1x is well-tested and proven [25]
- IDEF1x is automatable [25]

Our application of the *Polymorphic Table Modeling* pattern begins with the creation of a logical relational model (created with the IDEF1x modeling language). This is a necessary step in order to prepare the stage for the transition from *RM* to NoSQL data modeling. The transformation of the data requirements into the relational model allows the data modeler to freely model the requirements in a familiar fashion. At this point in the data modeling process we do not place any restrictions on the way the data is to be modeled. This approach of first modeling the relational model allows the data modeler to focus on entity identification. The entity identification process is crucial to our modeling proposal as each entity will later become either a *Polymorphic Table Entity* (standard or standalone) or *Polymorphic Table Column* (simple or complex). Our resulting entities represented the following objects types:

- project
- contract change order
- contract change order memo
- drawing
- drawing index
- drawing signoff
- revision history
- contractor
- authorization

- line item

Each entity was represented in our model with the IDEF1x default entity representation. We observed that IDEF1x's *generalization* concept could be applied to the *contract change order*, *contract change order memo*, and *drawing* entities. This resulted in the abstraction of the common properties to a new super-type entity named *document*. We proceeded to make the generalization complete and subsequently converted *contract change order*, *change order memo*, and *drawing* to sub-types of the *document* super-type. Next, we turned our attention to relationship identification. Non-identifying and identifying relationships were identified and modeled according to the IDEF1x specification. The following relationships were identified:

Table 2. Relationships from logical relational model

Parent Entity	Child Entity	Relationship Type
Project	contract change order	identifying
Project	contract change order memo	identifying
Project	drawing	identifying
Drawing	drawing signoff	identifying
Drawing	drawing index	identifying
Drawing	revision history	identifying
Contractor	contract change order	non-identifying
Contract Change Order	line item	identifying

Once the relationships were modeled we began our detailed attribute identification and modeling. The attribute identification process commenced with task of identifying primary keys each entity. The primary keys were specified and modeled in each entity using the IDEF1x standard notation. The remaining non-key attributes were identified and then populated in their corresponding entities. The resulting logical relational model is pictured in Figure 3. The use of IDEF1x to create the logical model provides validity to statement we made concerns the reuse of the data modeler's existing skillset.

9.2 Required Skillset – Data Model Refactoring

Data model refactoring is based on the concept of *database refactoring* which was introduced by Scott Ambler [1]. Database refactoring is described as “a simple change to a database schema that improves its design while retaining both its behavioral and informational semantics” [1]. Data model refactoring simply

applies database refactoring techniques to the logical model instead of the physical database. We found that our initial relational model required refactoring in order to be in the proper condition for the *Polymorphic Table* pattern to be applied. The discovery was made during our attempt to transform the *document* super-type and its subtypes to the appropriate *Polymorphic Table* pattern structures. We wanted to represent each subtype (*contract change order*, *contract change order memo*, and *drawing*) as a *Polymorphic Table Entity (PTE)*, but each subtype failed the criteria for eligibility. The pre-condition for becoming a *PTE* entity is that the relational model entity must be an independent entity. We applied a series of structural refactoring processes [1] based on the *Move Column*, *Merge Table*, and *Drop Table* refactoring techniques to address the violation. We were successful, and the former sub-types met the pre-condition for becoming *PTEs*.

The refactoring skillset may not be in the data modeler's tool belt, but it is needed. We would not have been able to complete our model transformation without refactoring. The need for refactoring has been an unintended, but welcomed side-effect of our modeling proposal.

9.3 Required Skillset – XML

XML is a new skill that is necessary for our NoSQL modeling solution. We primarily selected XML as a desired skillset for two specific reasons. The first reason is its ability to represent semi-structured data. The second reason is because of its ability to use hierarchical containment to express a data hierarchy. The NoSQL document object is hierarchical, and a vehicle is needed to properly model the data which it can contain. We therefore employ XML for our data modeling purposes. The employment of XML provides a two-fold advantage. XML first serves a bridge to applying the *Polymorphic Table* pattern. Secondly, the inclusion of XML helps transition the data modeler's manner of thinking to be "hierarchy centric." The shift in perspective may or may not be acquired quickly. Therefore, patience and an adequate learning time frame are required. Data modelers that are accustomed to using XML may find its application to be quite trivial. The end result of the XML application process is an established hierarchy that represents the intended structure of the NoSQL document.

We practiced the approach by converting our initial relational model (pre-refactoring) to XML. The conversion started with the selection of root node candidates. The following rule was used in the selection process: *A root node candidate is a relational entity that 1) participates as a parent in an identifying relationship 2) is not a child entity.* The rule-based selection approach yielded the *project* entity as a root node candidate. We created a new XML document and added the name of the *project* entity as the root tag. This resulted in the creation of single node, `<project/>`. Next, the entity's parent-child relationships were navigated to further build the hierarchy. We decided to take advantage of containment relationship aspect of XML and introduce the *document* super-type as a container for all of its subtypes (*contract change order*, *change order memo*, and *drawing*). The name of the *document* was pluralized to indicate the type of contents that would be stored, and the node was added to the `<project/>` node. The names of each of the *project's* children were appended to the new `<documents/>` node as child nodes. Recursion was used on each child entity to add their children to the XML document. We deliberately did not model attributes because our objective to create a hierarchical representation of our relational model. The XML document gave us our hierarchical view of our relational model, thus proving the need for the XML skill.

XSD (Xml Schema Definition) is a secondary skill the adopter of the *Polymorphic Table* pattern will find useful. Although it is not required, we strongly recommend that the data modeler acquires at the minimum, a familiarity. We used our knowledge of XSD to create the metadata for our physical implementation. We found that our meta-schema implementation shares characteristics of the *Salami Slice* [15] and *Russian Doll* [15] XML Schema design patterns. In *embedding* modeling style, the parent document can be considered to be the global element. Each *embedded* document would therefore be a local element. These aforementioned features parallel the characteristics of the *Russian Doll* design pattern. The *references* document modeling style is similar to the *Salami Slice* pattern. The *referenced SPTe* entity can be considered to be a global document. The parent document is also a global entity. But this is where the similarity ends, due to the fact that the parent document can contain types that are not declared globally.

The concepts of data typing, restrictions, and occurrence indicators were adopted to assist in the creation of the metadata. We mapped the cardinality of the relationship to our modified occurrence indicators (*minOccurrences* and *maxOccurrences*) for the *Polymorphic Table Column Complex* (PTCC). We also employed the concept of a *required* element in our metadata. This gave us the flexibility to specify whether or not an element needs to be present in a NoSQL document object.

Although we adopted some concepts and constructs from XML modeling, we discovered that the *Polymorphic Table* pattern presents distinct advantages over canonical XML modeling. Particularly, the *Polymorphic Table* pattern allows for a rich, graphical expression of hierarchical structures without the loss of data typing. Our pattern allows for primary key, alternate key, and index specification, which is not possible in XML Modeling. Finally, our pattern allows the data modeler to transition from the logical model to physical model with relative ease.

CHAPTER 10

CONCLUSION

We have presented the PT pattern as a solution to NoSQL data modeling issue for document store variety. Our polymorphic pattern addresses the issue of how to model a NoSQL document store database. The pattern takes into consideration the “schemaless” nature of the NoSQL database which allows for polymorphic schemas to be stored together in the same collection (table). It approaches the schemaless aspect by creating constructs and rules to govern the data modeling process such that a uniform data model is produced that is able to describe the complex hierarchies that are often in non-uniform data. Our contribution preserves the NoSQL schemaless quality, but offers the role of schema enforcement to the application layer.

In this work we presented a new methodology for data analysis and modeling for NoSQL database which preserves the interim work product Idef1x for future use. We are aware that PT pattern may appear to be daunting, and that there will be a learning curve which involves changing the way the data modeler approaches modeling data. Our new methodology seeks to ease this transition by utilizing the data modeling skillsets from relational database environments as well as XML schema environments.

We are actively pursuing the eventual automation of the entire data modeling process using contemporary case tools like Erwin. Directions for future work include a) defining code generation procedures for document store NoSQL DB engines and b) creating a NoSQL schema validator for the document store variety.

BIBLIOGRAPHY

- [1] Ambler, S.W. and Sadalage, P.J. 2006. *Refactoring Databases Evolutionary Database Design*. Addison-Wesley.
- [2] Badia, a. 2002. Conceptual modeling for semistructured data. *Proceedings of the Third International Conference on Web Information Systems Engineering (Workshops), 2002*. (2002), 170–177.
- [3] Bird, L. et al. 2000. Object role modelling and XML-Schema. *ER'00 Proceedings of the 19th international conference on Conceptual modeling*. (2000), 309–322.
- [4] Cardelli, L. and Wegner, P. 1985. On understanding types, data abstraction, and polymorphism. *ACM Computing Surveys*.
- [5] Chen, P. 1976. The Entity-Relationship Unified View of Data Model-Toward a. *ACM Transactions on Database Systems*. 1, 1 (1976), 9–36.
- [6] Chodorow, K. 2013. *MongoDB The Definitive Guide*. O'Reilly Media, Inc.
- [7] Clifton, C. et al. 1995. HyperFile: A data and query model for documents. *The VLDB Journal*. 4, 1 (Jan. 1995), 45–86.
- [8] Codd, E.F. 1983. A relational model of data for large shared data banks. *Communications of the ACM*. 26, 1 (Jan. 1983), 64–69.
- [9] Combi, C. and Oliboni, B. 2006. Conceptual modeling of XML data. *Proceedings of the 2006 ACM symposium on Applied computing - SAC '06*. (2006), 467–473.
- [10] Connolly, T. and Begg, C. 2010. *Database Systems: a practical approach to design, implementation, and management*. Addison-Wesley.
- [11] Copeland, R. 2013. *MongoDB Applied Design Patterns*. O'Reilly Media, Inc.
- [12] Data Models - MongoDB Manual 2.4.9: <http://docs.mongodb.org/manual/data-modeling/>. Accessed: 2014-03-26.
- [13] Ecma formal publications: <http://www.ecma-international.org/publications/files/ECMA-ST/ECMA-404.pdf>. Accessed: 2014-03-10.
- [14] Evans, E. 2004. Domain-Driven Design: Tackling Complexity in the Heart of Software. *Domain-Driven Design: Tackling Complexity in the Heart of Software*. Addison-Wesley. 529.
- [15] Introducing Design Patterns in XML Schemas: <http://www.oracle.com/technetwork/java/design-patterns-142138.html>. Accessed: 2014-03-27.
- [16] Jagadish, H. V et al. 2004. Colorful XML. *Proceedings of the 2004 ACM SIGMOD international conference on Management of data - SIGMOD '04* (New York, New York, USA, 2004), 251–262.

- [17] Jovanovic, V. and Benson, S. 2013. AGGREGATE DATA MODELING STYLE. *SAIS 2013 Proceedings*. (2013), 70–75.
- [18] Jr, E.W. 2002. Uniform comparison of data models using containment modeling. *Proceedings of the thirteenth ACM conference on* (2002), 182–191.
- [19] Kusiak, A. et al. 1997. Data modelling with IDEF1x. *International Journal of Computer Integrated Manufacturing*. 10, 6 (Jan. 1997), 470–486.
- [20] Liberty, J. 2003. Programming Visual Basic.Net. *Programming Visual Basic.NET*. O'Reilly Media, Inc. 74–75.
- [21] Lósió, B.F. et al. 2003. Conceptual modeling of XML schemas. *Proceedings of the fifth ACM international workshop on Web information and data management - WIDM '03* (New York, New York, USA, 2003), 102 – 105.
- [22] Mani, M. 2004. EReX: a conceptual model for XML. *Proceedings of the Second International XML Database Symposium*. (2004), 128–142.
- [23] MongoDB: <http://www.mongodb.org/>. Accessed: 2014-03-27.
- [24] Murthy, R. and Banerjee, S. 2003. Xml schemas in Oracle XML DB. *Proceedings of the 29th international conference on Very large databases*. 29, (2003), 1009–1018.
- [25] National Institute of Standards and Technology 1993. *Federal Information Processing Standards Publication 184*.
- [26] Necaský, M. 2006. Conceptual modeling for XML: A survey. *Proceedings of the DATESO 2006 Annual International Workshop on Databases, Texts, Specifications and Objects*. 176, (2006), 1–54.
- [27] Parsons, D. 2001. *Object Oriented Programming with C++*. Cengage Learning EMEA.
- [28] Primitive XML Data Types: [http://msdn.microsoft.com/en-us/library/ms256220\(v=vs.110\).aspx](http://msdn.microsoft.com/en-us/library/ms256220(v=vs.110).aspx). Accessed: 2014-03-28.
- [29] Psaila, G. 1999. ERX: a data model for collections of XML documents. *Proceedings 1999 Workshop on Knowledge and Data Engineering Exchange (KDEX'99) (Cat. No.PR00453)* (1999), 99–104.
- [30] Routledge, N. 2002. UML and XML Schema. *ADC '02 Proceedings of the 13th Australasian database conference*. 5, (2002), 157–166.
- [31] Roy, J. and Ramanujan, A. 2001. XML schema language: taking XML to the next level. *IT Professional*. 3, 2 (2001), 37–40.
- [32] Sadalage, P.J. and Fowler, M. 2013. *NoSQL Distilled A Brief Guide to the Emerging World of Polygot Persistence*. Addison-Wesley.
- [33] Sarkar, A. 2011. Conceptual Level Design of Semi-structured Database System: Graph-semantic Based Approach. *International Journal of Advanced Computer Science and Applications*. 2, 10 (2011), 112–121.
- [34] Schema - W3C: <http://www.w3.org/standards/xml/schema>. Accessed: 2014-03-28.

- [35] Shanmugasundaram, J. and Shekita, E. 2001. Efficiently publishing relational data as XML documents. *Proceedings of the 26th International Conference on Very Large Databases*. 10, 2-3 (2001), 133–154.
- [36] Smith, J.M. and Smith, D.C.P. 1977. Database abstractions: aggregation and generalization. *ACM Transactions on Database Systems*. 2, 2 (Jun. 1977), 105–133.
- [37] Understanding XML Schema: <http://msdn.microsoft.com/en-us/library/aa468557.aspx>. Accessed: 2014-03-05.
- [38] Unified Modeling Language (UML): www.uml.org. Accessed: 2014-03-25.
- [39] Vernon, V. 2013. *Implementing Domain-Driven Design*. Addison-Wesley.
- [40] Vollmar, G. 2001. Towards XML metamodel patterns for XML data modeling. *12th International Workshop on Database and Expert Systems Applications*. (2001), 71–75.
- [41] W3C XML Schema Definition Language (XSD) 1.1 Part 1: Structures: <http://www.w3.org/TR/xmlschema11-1/>. Accessed: 2014-03-28.
- [42] XML Schema Tutorial: .
- [43] XML Technology: <http://www.w3.org/standards/xml/>. Accessed: 2014-03-10.

APPENDIX A

META-SCHEMA COLLECTION

A.1 Meta-schema Collection – Schema.tables

The schema.tables collection contains the metadata for each PTE in the data model. The following metadata information is stored in each document in the collection.

Attribute - _id

The _id attribute is a MongoDB key which stores the unique (primary) key for the document in the collection. The _id can be any data type. Its data type is explicitly specified by the _idDataType attribute.

Attribute - _idDataType

The _idDataType attribute stores the data type of the _id key. The data type must be an element in the domain of common SQL data types. The data type is stored as a single string that includes the size and precision (if applicable). For example, a variable character string of size 100 is represented as "VARCHAR(100)."

Attribute – tableID

The tableID attribute stores the name or identifier of the polymorphic table that is being represented. The tableName can be any data type. Its data type is explicitly specified by the tableNameDataType attribute.

Attribute – useGlobalColumns

The useGlobalColumns attribute stores a boolean value which indicates whether the PTE document will implement the columns from the schema.table.global.columns collection.

A.2 Meta-schema Collection – Schema.table.containers

The schema.table.containers collection contains the metadata which facilitates the PTE aggregate hierarchies that are present in the logical model (represented with PTB and OC entities). The following metadata information is stored in each document in the collection.

Attribute - _id

The _id attribute is a MongoDB key which stores the unique (primary) key for the document in the collection. The _id can be any data type. Its data type is explicitly specified by the _idDataType attribute.

Attribute - _idDataType

The _idDataType attribute stores the data type of the _id key. The data type must be an element in the domain of common SQL data types. The data type is stored as a single string that includes the size and precision (if applicable). For example, a variable character string of size 100 is represented as “VARCHAR(100).”

Attribute – containerID

The containerID attribute stores the name or identifier of the OC entity that is being represented. The value of the containerID will be inserted as a key in the PTE document. The data type is explicitly specified by the containerIDDataType attribute.

Attribute – containerIDDataType

The containerIDDataType attribute stores the data type of the containerID attribute. The data type must be an element in the domain of common SQL data types. The data type is stored as a single string that includes the size and precision (if applicable). For example, a variable character string of size 100 is represented as “VARCHAR(100).”

Attribute – parentContainerID

The parentContainerID stores name of the key that will appear in the PTE document. The actual parentContainerID will be set as the key’s value in the parent PTE as well. The parentContainerID can be any data type. Its data type is explicitly specified by the parentContainerIDDataType attribute.

Attribute – parentIDDataType

The parentIDDataType attribute stores the data type of the parentIDDataType attribute. The data type must be an element in the domain of common SQL data types. The data type is stored as a single string that includes the size and precision (if applicable).

Attribute – parentContainerRequired

The parentContainerRequired attribute stores a boolean value which indicates whether the column is required to make the schema valid. If required equal false, then all of the container column information may be omitted from the PTE document.

Attribute – parentTableID

The parentTableID stores the `_id` field of the parent PTE document (located in the `schema.tables` collection).

Attribute – parentTableIDDataType

The parentTableIDDataType attribute stores the data type of the parentTableIDDataType attribute. The data type must be an element in the domain of common SQL data types. The data type is stored as a single string that includes the size and precision (if applicable).

Attribute – required

The required attribute stores a boolean value which indicates whether the column is required to make the schema valid. If required equal false, then the column does not have to be included in the document.

Attribute – childTables

The childTables attribute is a key that is used to establish the child-parent PTE document relationships which are present in the PTB entities of the logical model. The key name will actually be inserted into the PTE document as a key. The newly formed childTables key (in the PTE document) can be assigned an array of embedded documents containing childTableID keys. The childTable attribute contains the following key-value pairs: required, minOccurrences, maxOccurrences, childTableID, and childTableIDDataType.

Attribute - parentContainerRequired

The `parentContainerRequired` attribute stores a boolean value which indicates whether the column is required to make the schema valid. If required equal false, then all of the container column information may be omitted from the PTE document.

Attribute – `childTables`, Embedded Key - required

The required attribute determines whether `childTablesColumn` key is required to make the OC schema valid. If the value is set to false, then the key does not have to be present.

Attribute – `childTables`, Embedded Key - `maxOccurrences`

The `maxOccurrences` attribute establishes the allowed maximum number of child table embedded documents within the `childTables` attribute. The possible values are 1 to infinity. Infinity is notated by the phrase “UNBOUNDED.”

Attribute – `childTables`, Embedded Key - `minOccurrences`

The `minOccurrences` attribute establishes the required minimum number of child table embedded documents within the `childTables` attribute. The possible values are 0 to infinity. Infinity is notated by the phrase “UNBOUNDED.”

Attribute – `childTables`, Embedded Key - `childTableID`

The `childTableID` stores a placeholder name in lieu of the name of the child PTCC entity. The placeholder becomes a key in the embedded document within the PTE document’s `childTables` attribute. The actual `-child PTEs _id` will be assigned to the key inside the PTE document.

Attribute – `childTables` - Embedded Key - `childTableIDDataType`

The `childTableIDDataType` attribute stores the data type of the `childTableID` attribute. The data type must be an element in the domain of common SQL data types. The data type is stored as a single string that includes the size and precision (if applicable).

A.3 Meta-schema Collection – `Schema.table.global.columns`

The `schema.table.global.columns` collection contains the metadata for common “columns” that can be applied to any Polymorphic Table Entity (PTE) in the data model. For example, the `MongoDB _id` key can be of any data

type. If the modeler wished to restrict the data type for each PTE's `_id`, the column and its type would be declared in this collection. The restriction would apply to any PTE in the `schema.tables` collection whose `useGlobalColumns` key equal `true`. The metadata stored in the `schema.table.global.columns` is described in the following sections.

Attribute – `globalColumnName`

The `globalColumnName` attribute stores name (or identifier) of the “common” column. The attribute data type can any database supported data type. However, its data type is explicitly specified by the `globalColumnNameDataType` attribute.

Attribute - `globalColumnNameDataType`

The `globalColumnNameDataType` attribute stores the data type of the `globalColumnName` attribute. The data type must be an element in the domain of common SQL data types. The data type is stored as a single string that includes the size and precision (if applicable). For example, a variable character string of size 100 is represented as “`VARCHAR(100)`.”

A.4 Meta-schema Collection – `Schema.table.columns.simple`

The `schema.table.columns.simple` collection contains the combined metadata for each PTCS entity and its corresponding PTCVS entity in the data model. The following metadata information is stored in each document in the collection.

Attribute - `_id`

The `_id` attribute is a MongoDB key which stores the unique (primary) key for the document in the collection. The `_id` can be any data type. Its data type is explicitly specified by the `_idDataType` attribute.

Attribute - `_idDataType`

The `_idDataType` attribute stores the data type of the `_id` key. The data type must be an element in the domain of common SQL data types. The data type is stored as a single string that includes the size and precision (if applicable). For example, a variable character string of size 100 is represented as “`VARCHAR(100)`.”

Attribute – tableID

The tableID attribute stores the name or identifier of the polymorphic table that is being represented. The tableID can be any data type. Its data type is explicitly specified by the tableIDDataType attribute.

Attribute - tableIDDataType

The tableIDDataType attribute stores the data type of the tableID attribute. The data type must be an element in the domain of common SQL data types. The data type is stored as a single string that includes the size and precision (if applicable). For example, a variable character string of size 100 is represented as “VARCHAR(100).”

Attribute – columnName

The columnName attribute stores the name or identifier the PTCV entity. The columnName can be any data type. Its data type is explicitly specified by the columnNameDataType attribute.

Attribute – columnNameDataType

The columnNameDataType attribute stores the data type of the columnName attribute. The data type must be an element in the domain of common SQL data types. The data type is stored as a single string that includes the size and precision (if applicable). For example, a variable character string of size 100 is represented as “VARCHAR(100).”

Attribute – columnValueDataType

The columnValueDataType attribute stores the data type of the value of the PTCV entity. The data type must be an element in the domain of common SQL data types. The data type is stored as a single string that includes the size and precision (if applicable). For example, a variable character string of size 100 is represented as “VARCHAR(100).”

Attribute – required

The required attribute stores a boolean value which indicates whether the column is required to make the schema valid. If required equal false, then the column does not have to be included in the document. The functionality provides the ability to have nullable fields without having to store nulls. The required attribute also shows the polymorphic model’s strength, by allowing documents with varying fields to compose the same table.

Attribute - referencedTableID

The referencedTableID attribute stores a placeholder name instead of the actual name of the key name (identifier) of the Standalone Polymorphic Table (SPT) that is being referenced. The actual name of the referenced SPT will be assigned in the document representation of Polymorphic Table Entity (PTE). The attribute can be any data type. Its data type is explicitly specified by the referencedTableIDDataType attribute. This attribute is not required if the referencedColumnRequired is set to false.

Attribute – referencedTableIDDataType

The referencedTableIDDataType attribute stores the data type of the value that will be stored in the referencedTableID attribute. The data type must be an element in the domain of common SQL data types. The data type is stored as a single string that includes the size and precision (if applicable). For example, a variable character string of size 100 is represented as “VARCHAR(100).” This attribute is not required if the referencedColumnRequired is set to false.

Attribute – referencedColumnName

The referencedColumnName attribute stores a placeholder name instead of the actual name of the column. The actual column name will be assigned to the placeholder key-value pair inside the document representation of the Polymorphic Table Column Simple entity. The actual column name is the name of column of the SPT entity that is being referenced. The referencedColumnName can be any data type. Its data type is explicitly specified by the referencedColumnNameDataType attribute. This attribute is not required if the referencedColumnRequired is set to false.

Attribute – referencedColumnNameDataType

The referencedColumnNameDataType attribute stores the data type of the value that will be stored in the referencedColumnName attribute. The data type must be an element in the domain of common SQL data types. The data type is stored as a single string that includes the size and precision (if applicable). For example, a variable character string of size 100 is represented as “VARCHAR(100).” This attribute is not required if the referencedColumnRequired is set to false.

Attribute – referencedColumnRequired

The referencedColumnRequired attribute stores a boolean value which indicates whether the following columns are required column is required to make the schema valid: referencedTableID, referencedTableIDDataType, referencedColumnName, and referencedColumnNameDataType. If required equal false, then the column does not have to be included in the document.

A.5 Meta-schema Collection - table.columns.complex

The schema.table.columns.complex collection contains the combined metadata for all PTCC entities and their associated PTCA and PTCVC entities in the data model. The following metadata information is stored in each document in the collection.

Attribute - _id

The _id attribute is a MongoDB key which stores the unique (primary) key for the document in the collection. The _id can be any data type. Its data type is explicitly specified by the _idDataType attribute.

Attribute - _idDataType

The _idDataType attribute stores the data type of the _id key. The data type must be an element in the domain of common SQL data types. The data type is stored as a single string that includes the size and precision (if applicable). For example, a variable character string of size 100 is represented as "VARCHAR(100)."

Attribute – tableID

The tableID attribute stores the name or identifier of the polymorphic table that is being represented. The tableID can be any data type. Its data type is explicitly specified by the tableIDDataType attribute.

Attribute - tableIDDataType

The tableIDDataType attribute stores the data type of the tableID attribute. The data type must be an element in the domain of common SQL data types. The data type is stored as a single string that includes the size and precision (if applicable). For example, a variable character string of size 100 is represented as "VARCHAR(100)."

Attribute – columnName

The columnName attribute stores the name or identifier the PTCS entity. The columnName can be any data type. Its data type is explicitly specified by the columnNameDataType attribute.

Attribute – columnNameDataType

The columnNameDataType attribute stores the data type of the columnName attribute. The data type must be an element in the domain of common SQL data types. The data type is stored as a single string that includes the size and precision (if applicable). For example, a variable character string of size 100 is represented as “VARCHAR(100).”

Attribute – required

The required attribute stores a boolean value which indicates whether the column is required to make the schema valid. If required equal false, then the column does not have to be included in the document. The functionality provides the ability to have nullable fields without having to store nulls.

Attribute – minOccurrences

The minOccurrences attribute stores the minimum possible number of occurrences of the PTCC in its parent document. The possible values are 0 to infinity. Infinity is notated by the phrase “UNBOUNDED.” It is for this reason that value is stored as a string.

Attribute – maxOccurrences

The maxOccurrences attribute stores the maximum possible number of occurrences of the PTCC in its parent document. The possible values are 1 to infinity. Infinity is notated by the phrase “UNBOUNDED.” It is for this reason that value is stored as a string.

Attribute – parentColumn

The parentColumn attribute is an embedded document that represents the parent PTCC column. The embedded document contains the following key-value pairs: required, parentColumnID, and parentColumnIDDataType.

Attribute – parentColumn, Embedded Key - required

The required attribute determines whether parentColumn is needed to make the current PTCC schema valid. If the value is set to false, then the column does not have to be populated.

Attribute – parentColumn, Embedded Key – parentColumnID

The parentColumnID stores a placeholder name instead of the actual name of the parent PTCC entity. The placeholder becomes a key in the parentColumn embedded document in the stored PTE document. The actual parentColumnID will be set in the PTE's document. The parentColumnID can be any data type. Its data type is explicitly specified by the parentColumnIDDataType attribute.

Attribute – parentColumn, Embedded Key – parentColumnIDDataType

The parentColumnIDDataType attribute stores the data type of the parentColumnID attribute. The data type must be an element in the domain of common SQL data types. The data type is stored as a single string that includes the size and precision (if applicable). For example, a variable character string of size 100 is represented as "VARCHAR(100)."

Attribute – columnAttributes

The columnAttributes attribute is an array of embedded documents that which contains the metadata for the PTCC's associated PTCA entities. The key name will be inserted into the PTE document. The following keys are contained in each embedded document: codeEnforcedPrimaryKey, columnName, columnNameDataType, columnAttributeRequired, referencedTableID, referencedTableIDDataType, referencedColumnName, referencedColumnNameDataType, and referencedColumnRequired.

Attribute – columnAttributes, Embedded Key – codeEnforcedPrimaryKey

The codeEnforcedPrimaryKey attribute stores a boolean value which identifies the current columnAttribute embedded document as the primary key. In MongoDB, unique indexes are maintained across the entire document collection. This can create a problem if there are several documents that have embedded documents which contain the same columnName. To avoid this pitfall, the codeEnforcedPrimaryKey attribute is created. If set to true, the application layer is responsible for limiting the scope of the uniqueness to all PTE documents with the same tableID as the parent PTE document.

Attribute – columnAttributes, Embedded Key – columnName

The columnName stores the value contained in the attributeName property in the associated PTCA entity. The attribute can be any data type. Its data type is explicitly specified by the columnNameDataType attribute.

Attribute – columnAttributes, Embedded Key – columnNameDataType

The columnNameDataType attribute stores the data type of the columnName attribute. The data type must be an element in the domain of common SQL data types. The data type is stored as a single string that includes the size and precision (if applicable). For example, a variable character string of size 100 is represented as “VARCHAR(100).”

Attribute – columnAttributes, Embedded Key – required

The required attribute determines whether current columnAttribute embedded document attribute is needed to make the current PTCC schema valid. If the value is set to false, then the column does not have to be populated.

Attribute – columnAttributes, Embedded Key – referencedTableID

The referencedTableID attribute stores a placeholder name instead of the actual name of the key name (identifier) of the SPT entity that is being referenced. The actual name of the referenced SPT will be assigned in the document representation of PTE. The attribute can be any data type. Its data type is explicitly specified by the referencedTableIDDataType attribute. This attribute is not required if the referencedColumnRequired is set to false.

Attribute – columnAttributes, Embedded Key – referencedTableIDDataType

The referencedTableIDDataType attribute stores the data type of the value that will be stored in the referencedTableID attribute. The data type must be an element in the domain of common SQL data types. The data type is stored as a single string that includes the size and precision (if applicable). For example, a variable character string of size 100 is represented as “VARCHAR(100).” This attribute is not required if the referencedColumnRequired is set to false.

Attribute – columnAttributes, Embedded Key – referencedColumnName

The referencedColumnName attribute stores a placeholder name instead of the actual name of the column. The actual column name will be assigned to the placeholder key-value pair inside the document representation of the Polymorphic Table Column Simple entity. The actual column name is the name of column of the SPT entity that is being referenced. The referencedColumnName can be any data type. Its data type is explicitly specified by the referencedColumnNameDataType attribute. This attribute is not required if the referencedColumnRequired is set to false.

Attribute – columnNameDataTypes, Embedded Key – referencedColumnNameDataTypes

The referencedColumnNameDataTypes attribute stores the data type of the value that will be stored in the referencedColumnName attribute. The data type must be an element in the domain of common SQL data types. The data type is stored as a single string that includes the size and precision (if applicable). For example, a variable character string of size 100 is represented as “VARCHAR(100).” This attribute is not required if the referencedColumnNameRequired is set to false.

Attribute – columnNameDataTypes, Embedded Key – referencedColumnNameRequired

The referencedColumnNameRequired attribute stores a boolean value which indicates whether the following columns are required column is required to make the schema valid: referencedTableID, referencedTableIDDataTypes, referencedColumnName, and referencedColumnNameDataTypes. If required equal false, then the column does not have to be included in the document.

Attribute – childComplexColumns

The childComplexColumns attribute is an array of embedded documents that stores the parent-child PTCC entity relationships represented in the PTCCB entity. The embedded document contains the following key-value pairs: required, minOccurrences, maxOccurrences, childComplexColumnID, and childComplexColumnIDDataTypes.

Attribute – childComplexColumns, Embedded Key - required

The required attribute determines whether childComplexColumn attribute is needed to make the current PTCC schema valid. If the value is set to false, then the column does not have to be populated.

Attribute – childComplexColumns, Embedded Key – maxOccurrences

The maxOccurrences attribute establishes the allowed maximum number of children PTCC embedded documents within the childComplexColumns attribute. The possible values are 1 to infinity. Infinity is notated by the phrase “UNBOUNDED.”

Attribute – childComplexColumns, Embedded Key - minOccurrences

The minOccurrences attribute establishes the required minimum number of children PTCC embedded documents within the childComplexColumns attribute. The possible values are 0 to infinity. Infinity is notated by the phrase "UNBOUNDED."

Attribute – childComplexColumns, Embedded Key –childComplexColumnID

The childComplexColumnID stores a placeholder name in lieu of the name of the child PTCC entity. The placeholder becomes a key in the embedded document within the childComplexColumns attribute.

Attribute – childComplexColumns, Embedded Key – childComplexColumnIDDataType

The childComplexColumnIDDataType attribute stores the data type of the columnName attribute. The data type must be an element in the domain of common SQL data types. The data type is stored as a single string that includes the size and precision (if applicable). For example, a variable character string of size 100 is represented as "VARCHAR(100)."

APPENDIX B

TECHNOLOGY BACKGROUND

B.1 MongoDB

B.1.1 What is MongoDB?

MongoDB is an “open-source document database that provides high performance, high availability, and automatic scaling” [23]. MongoDB is a member of the NoSQL community. As a member of the NoSQL community, MongoDB shares the common characteristic of being *schemaless*. This means that it does not require a defined schema, before the database can be used. Being that MongoDB is a document store database, the *document* object is its base concept.

B.1.2 Document Object

In MongoDB, the main concept is the *document* object. The *document* object is comparable to a row in a relational database management system [32]. It is a data structure that is composed of key-value pairs. The flexible *document* object allows for the embedding of documents and arrays. This “document-oriented” approach allows for the representation of complex hierarchical relationships in a single document [12]. Each document contains key identifier (primary key) referred to as the *_id* key. The *_id* can be any data type but it default to the *ObjectId* data type. Documents can also be stored in the value portion of the key-value pair of the *document* object. Documents that are stored in this fashion are referred to as *embedded documents*. The *document* is stored in MongoDB as a JSON object. An example of a document is below.

```
{
  "_id": 123,
  "owner": "Bob",
  "age": 33,
  "state": "NC"
}
```

Figure 24 MongoDB document example

Since a document object is similar to row in a relational database system, it can be reasoned that there must be a concept of a table as well. In fact, MongoDB does provide the concept called a *collection*.

B.1.3 Collection Object

The *collection* object is a group of documents. The object has a *dynamic schema* [12]. This is an important concept, because this trait allows heterogeneous documents to be stored in the same collection. A

key rule for MongoDB collections is that each document key identifier, *_id*, must be unique for every document in the collection. There are also other rules regarding the naming of collections [12]:

- Empty string cannot be used a collection name
- The null character (\0) cannot be used in a collection name
- User created collections should not the \$ reserved character
- Collections should not begin with the *system.* prefix

B.1.4 Data Types

The following data types are supported in the MongoDB document object:

- null
- boolean
- number
- string
- date
- regular expressions
- embedded document
- objectID
- binary data
- code

B.1.5 Indexing

The MongoDB database supports the use of indexes (both unique and “normal”). The system allows for both simple and compound indexes. MongoDB also grants the database developer the ability to index embedded documents.

B.2 JSON

B.2.1 What is JSON?

Javascript Object Notation (JSON) is a lightweight, text-based, language-independent, data-interchange format [13]. The key components of JSON are: a collection of name-value pairs and an order list of values .

B.2.2 JSON Object

A JSON object is a set of unordered name-value pairs. It is represented a pair of curly brackets surrounded by zero or more name-value pairs. The name portion of the name-value pair is always a string value. The value portion is one of the supported JSON data types. A sample JSON object is shown below.

```
{
  "_id": "studentA",
  "name": "Scholar Owl",
  "classification": "senior"
}
```

Figure 25 JSON Object example

B.2.3 Value

A value in JSON must be one of the following data types:

- string

A *string* is a sequence of Unicode characters which are wrapped in quotation marks [13]. The string allows for the use of the *backslash* control character.

- number

A *number* in JSON is represented in base 10 [13] A number can contain a decimal and/or an exponent 10 ten (the exponent is denoted with the symbol *e*). It is important to note that *infinity* and *NaN* are not supported.

- object

The *object* is a valid JSON object

- array

An array is a collection of order values.

- boolean

A Boolean in JSON is represent as either *true* or *false*

- null

A null value is specified with the of the word *null*.

B.2.4 Array

Arrays in JSON are collection of ordered values which must be one of the supported value data types. Each array in JSON is enclosed in a set of brackets ([]), and each value inside of the brackets is delimited with a comma. An example of a JSON array is shown below.

```
{
  "phone": [
    {
      "phoneNumber": "704-888-8111",
      "phoneNumberType": "mobile"
    },
    {
      "phoneNumber": "704-777-9541",
      "phoneNumberType": "home"
    }
  ]
}
```

Figure 26. JSON Array example

B.3 XML Schema Definition Language

B.3.1 What is XML Schema Definition Language?

XML Schema Definition Language (XSD) is a language that offers the means for describing the structure and constraining documents [41]. The language itself is created with XML. XSD creates a type system for XML [28, 37], which is necessary because XML is a text-based language. XSD provides the constructs for specifying valid constraints and structures [31] in addition to the type system provision. The language also provides considerable improvements over its predecessor, the *Document Type Definition (DTD)*. The *DTD* is used to define the legal structure of an XML document. *DTD* originates from the *Structured Generalized Markup Language*. Some ways in which *DTD* differs from *XSD* are:

- *DTD* has limited data typing capabilities

- DTD is not XML-based
- DTD does not support namespaces

B.3.2 XSD Features

B.3.2.1 Data Typing

XSD gives the XML the ability to be richly data typed. The schema definition language provides the following built-in data types [28]:

Table 3 XSD data types

Data Type	Description
string	a sequence of characters
boolean	represents <i>true</i> or <i>false</i>
decimal	represents a decimal
float	single-precision 32-bit floating-point number
double	double-precision 64-bit floating-point number
duration	a length of time
dateTime	a specific instance of time with the format (CCYY-MM-DDThh:mm:ss) <ul style="list-style-type: none"> • CC – century • YY – year • DD – day • T – date/time separator • hh – hours • mm – minutes • ss – seconds
time	instance of time that reoccurs each day with format (hh:mm:ss.sss)
date	a calendar date with format (CCYY-MM-DD)
gYearMonth	Gregorian month in a specific Gregorian year
gYear	Gregorian year
gDay	Gregorian day
gMonth	Gregorian month
hexBinary	hex-encoded binary data
base64Binary	Base64-encoded arbitrary data
anyURI	URI as specified in RFC 2396
QName	qualified name
NOTATION	a notation attribute that is composed of QNames

XSD does not limit the data modeler or programmer to the primitive types. It also provides the constructs to create user-defined data types.

B.3.2.2 Complex Elements

In XML, a complex element is an element that is composed of one or more elements and/or attributes. Complex elements can be categorized into one of the following categories [42]:

- contains both elements and text
- contains only text
- contains only elements
- contains empty elements

An example of a complex element is shown below.

```
<student>
  <name>bob</name>
  <age>23</age>
</student>
```

Figure 27 XML sample document

The same complex element defined in XSD is shown below.

```
<xs:schema attributeFormDefault="unqualified" elementFormDefault="qualified"
  xmlns:xs="http://www.w3.org/2001/XMLSchema">
  <xs:element name="student">
    <xs:complexType>
      <xs:sequence>
        <xs:element name="name" type="xs:string" />
        <xs:element name="age" type="xs:integer" />
      </xs:sequence>
    </xs:complexType>
  </xs:element>
</xs:schema>
```

Figure 28 XSD sample document

B.3.2.3 XSD Restrictions

The XML schema definition language uses restrictions (for attributes) and facets (for elements) to enforce data specifications (acceptable values and format). Some of the restrictions are shown below: enumerati

- fractionDigits

This constraint is used to specify the number of allowed decimal places.

- Length

The constraint specifies the number of characters or list item allowed.

B.3.2.4 XSD Indicators

Indicators are used in XSD define how the elements will be used in the XML document. XSD provides for the following seven indicators [34]:

Table 4 XSD indicators

Indicator Name	Description
All	The <i>All</i> indicator is an <i>order</i> indicator. It is used to specify that the parent element's children can appear in any order, and must occur only one time.
Choice	The <i>Choice</i> indicator is an <i>order</i> indicator. It is used to specify that only one of the parent element's child elements can occur.
Sequence	The <i>Sequence</i> indicator is an <i>order</i> indicator. It is used to specify that the parent element's children must appear in the specified order.
maxOccurs	The <i>maxOccurs</i> indicator is an <i>occurrence</i> indicator. It specifies the maximum number of occurrences allowed for an element.
minOccurs	The <i>minOccurs</i> indicator is an <i>occurrence</i> indicator. It specifies the minimum number of occurrences allowed for an element.
group	The <i>group</i> indicator is used to create a set of related elements.
attributeGroup	The <i>attributeGroup</i> indicator is used to create a set of related attributes.

APPENDIX C

SOURCE CODE

C.1 Mongo Data Import Statements

```
mongoimport --db thesis --collection schema.tables < "C:\Classwork\Thesis\MongoWork\schema.tables.json" --jsonArray
mongoimport --db thesis --collection schema.table.columns.simple < "C:\Classwork\Thesis\MongoWork\schema.table.columns.simple.json" --jsonArray
mongoimport --db thesis --collection schema.table.columns.complex < "C:\Classwork\Thesis\MongoWork\schema.table.columns.complex.json" --jsonArray
mongoimport --db thesis --collection schema.table.containers < "C:\Classwork\Thesis\MongoWork\schema.table.containers.json" --jsonArray
```

APPENDIX D

EXPERIMENTAL DATA

D.1 Schema.tables

```
[
  {
    "_id": "PT_Project",
    "_idDataType": "VARCHAR(100)",
    "tableName": "PT_Project",
    "tableNameDataType": "VARCHAR(50)",
    "useGlobalColumns": true
  },
  {
    "_id": "PT_ContractChangeOrder",
    "_idDataType": "VARCHAR(100)",
    "tableName": "PT_ContractChangeOrder",
    "tableNameDataType": "VARCHAR(50)",
    "useGlobalColumns": true
  },
  {
    "_id": "PT_ContractChangeOrderMemo",
    "_idDataType": "VARCHAR(100)",
    "tableName": "PT_ContractChangeOrderMemo",
    "tableNameDataType": "VARCHAR(50)",
    "useGlobalColumns": true
  },
  {
    "_id": "PT_Drawing",
```



```

    "_idDataType": "VARCHAR(100)",
    "tableName": "PT_Drawing",
    "tableNameDataType": "VARCHAR(50)",
    "useGlobalColumns": true
  },
  {
    "_id": "SPT_Contractor",
    "_idDataType": "VARCHAR(100)",
    "tableName": "SPT_Contractor",
    "tableNameDataType": "VARCHAR(50)",
    "useGlobalColumns": true
  }
]

```

D.2 Schema.table.global.columns

```

[
  {
    "globalColumnName": "_id",
    "globalColumnNameDataType": "VARCHAR(100)"
  }
]

```

D.3 Schema.table.containers

```

[
  {
    "_id": "OC_Documents",
    "_idTDataType": "VARCHAR(100)",
    "containerID": "OC_Documents",
    "containerIDDataType": "VARCHAR(100)",

```

```

"required": false,
"parentContainerID": "parentContainer",
"parentContainerIDDataType": "VARCHAR(100)",
"parentContainerRequired": false,
"parentTableID": "PT_Project",
"parentTableIDDataType": "VARCHAR(100)",
"childTables": {
  "required": false,
  "minOccurrences": "1",
  "maxOccurrences": "UNBOUNDED",
  "childTableID": "childTable",
  "childTableIDDataType": "VARCHAR(100)"
}
}
]

```

D.4 Schema.table.columns.simple

```

[
{
  "_id": "PTCS_Project_ProjectCode",
  "_idDataType": "VARCHAR(100)",
  "tableID": "PT_Project",
  "tableIDDataType": "VARCHAR(100)",
  "columnName": "PTCS_Project_ProjectCode",
  "columnNameDataType": "VARCHAR(100)",
  "columnValueDataType": "VARCHAR(4)",
  "required": true,
  "referencedTableID": "referencedTableID",
  "referencedTableIDDataType": "VARCHAR(100)",

```

```

    "referencedColumnName": "referencedColumnName",
    "referencedColumnNameDataType": "VARCHAR(100)",
    "referencedColumnRequired": false
  },
  {
    "_id": "PTCS_Project_ProjectNo",
    "_idDataType": "VARCHAR(100)",
    "tableID": "PT_Project",
    "tableIDDataType": "VARCHAR(100)",
    "columnName": "PTCS_Project_ProjectNo",
    "columnNameDataType": "VARCHAR(100)",
    "columnValueDataType" : "VARCHAR(4)",
    "required": true,
    "referencedTableID": "referencedTableID",
    "referencedTableIDDataType": "VARCHAR(100)",
    "referencedColumnName": "referencedColumnName",
    "referencedColumnNameDataType": "VARCHAR(100)",
    "referencedColumnRequired": false
  },
  {
    "_id": "PTCS_ContractChangeOrder_DocumentIdentifier",
    "_idDataType": "VARCHAR(100)",
    "tableID": "PT_ContractChangeOrder",
    "tableIDDataType": "VARCHAR(100)",
    "columnName": "PTCS_ContractChangeOrder_DocumentIdentifier",
    "columnNameDataType": "VARCHAR(100)",
    "columnValueDataType" : "VARCHAR(30)",
    "required": true,
    "referencedTableID": "referencedTableID",

```

```

"referencedTableIDDataType": "VARCHAR(100)",
"referencedColumnName": "referencedColumnName",
"referencedColumnNameDataType": "VARCHAR(100)",
"referencedColumnRequired": false
},
{
  "_id": "PTCS_ContractChangeOrder_DocumentName",
  "_idDataType": "VARCHAR(100)",
  "tableID": "PT_ContractChangeOrder",
  "tableIDDataType": "VARCHAR(100)",
  "columnName": "PTCS_ContractChangeOrder_DocumentName",
  "columnNameDataType": "VARCHAR(100)",
  "columnValueDataType" : "VARCHAR(30)",
  "required": true,
  "referencedTableID": "referencedTableID",
  "referencedTableIDDataType": "VARCHAR(100)",
  "referencedColumnName": "referencedColumnName",
  "referencedColumnNameDataType": "VARCHAR(100)",
  "referencedColumnRequired": false
},
{
  "_id": "PTCS_ContractChangeOrder_FilePath",
  "_idDataType": "VARCHAR(100)",
  "tableID": "PT_ContractChangeOrder",
  "tableIDDataType": "VARCHAR(100)",
  "columnName": "PTCS_ContractChangeOrder_FilePath",
  "columnNameDataType": "VARCHAR(100)",
  "columnValueDataType" : "VARCHAR(100)",
  "required": true,

```

```

"referencedTableID": "referencedTableID",
"referencedTableIDDataType": "VARCHAR(100)",
"referencedColumnName": "referencedColumnName",
"referencedColumnNameDataType": "VARCHAR(100)",
"referencedColumnRequired": false
},
{
"_id": "PTCS_ContractChangeOrder_ContractModificationTitle",
"_idDataType": "VARCHAR(100)",
"tableID": "PT_ContractChangeOrder",
"tableIDDataType": "VARCHAR(100)",
"columnName": "PTCS_ContractChangeOrder_ContractModificationTitle",
"columnNameDataType": "VARCHAR(100)",
"columnValueDataType" : "VARCHAR(100)",
"required": true,
"referencedTableID": "referencedTableID",
"referencedTableIDDataType": "VARCHAR(100)",
"referencedColumnName": "referencedColumnName",
"referencedColumnNameDataType": "VARCHAR(100)",
"referencedColumnRequired": false
},
{
"_id": "PTCS_ContractChangeOrder_MemoText",
"_idDataType": "VARCHAR(100)",
"tableID": "PT_ContractChangeOrder",
"tableIDDataType": "VARCHAR(100)",
"columnName": "PTCS_ContractChangeOrder_MemoText",
"columnNameDataType": "VARCHAR(100)",
"columnValueDataType" : "VARCHAR(2000)",

```

```

"required": true,
"referencedTableID": "referencedTableID",
"referencedTableIDDataType": "VARCHAR(100)",
"referencedColumnName": "referencedColumnName",
"referencedColumnNameDataType": "VARCHAR(100)",
"referencedColumnRequired": false
},
{
  "_id": "PTCS_ContractChangeOrder_ContractorID",
  "_idDataType": "VARCHAR(100)",
  "tableID": "PT_ContractChangeOrder",
  "tableIDDataType": "VARCHAR(100)",
  "columnName": "PTCS_ContractChangeOrder_ContractorID",
  "columnNameDataType": "VARCHAR(15)",
  "columnValueDataType" : "INTEGER",
  "required": true,
  "referencedTableID": "referencedTableID",
  "referencedTableIDDataType": "VARCHAR(100)",
  "referencedColumnName": "referencedColumnName",
  "referencedColumnNameDataType": "VARCHAR(100)",
  "referencedColumnRequired": false
},
{
  "_id": "PTCS_ContractChangeOrder_LOCATION",
  "_idDataType": "VARCHAR(100)",
  "tableID": "PT_ContractChangeOrder",
  "tableIDDataType": "VARCHAR(100)",
  "columnName": "PTCS_ContractChangeOrder_LOCATION",
  "columnNameDataType": "VARCHAR(100)",

```

```

"columnValueDataType" : "VARCHAR(10)",
"required": true,
"referencedTableID": "referencedTableID",
"referencedTableIDDataType": "VARCHAR(100)",
"referencedColumnName": "referencedColumnName",
"referencedColumnNameDataType": "VARCHAR(100)",
"referencedColumnRequired": false
},
{
  "_id": "PTCS_ContractChangeOrder_CostChangeIndicator",
  "_idDataType": "VARCHAR(100)",
  "tableID": "PT_ContractChangeOrder",
  "tableIDDataType": "VARCHAR(100)",
  "columnName": "PTCS_ContractChangeOrder_CostChangeIndicator",
  "columnNameDataType": "VARCHAR(100)",
  "columnValueDataType" : "CHAR(1)",
  "required": true,
  "referencedTableID": "referencedTableID",
  "referencedTableIDDataType": "VARCHAR(100)",
  "referencedColumnName": "referencedColumnName",
  "referencedColumnNameDataType": "VARCHAR(100)",
  "referencedColumnRequired": false
},
{
  "_id": "PTCS_ContractChangeOrder_CostChangeAmount",
  "_idDataType": "VARCHAR(100)",
  "tableID": "PT_ContractChangeOrder",
  "tableIDDataType": "VARCHAR(100)",
  "columnName": "PTCS_ContractChangeOrder_CostChangeAmount",

```

```

"columnNameDataType": "VARCHAR(100)",
"columnValueDataType" : "DECIMAL(10,2)",
"required": true,
"referencedTableID": "referencedTableID",
"referencedTableIDDataType": "VARCHAR(100)",
"referencedColumnName": "referencedColumnName",
"referencedColumnNameDataType": "VARCHAR(100)",
"referencedColumnRequired": false
},
{
  "_id": "PTCS_ContractChangeOrder_NumOfDaysToCompleteWork",
  "_idDataType": "VARCHAR(100)",
  "tableID": "PT_ContractChangeOrder",
  "tableIDDataType": "VARCHAR(100)",
  "columnName": "PTCS_ContractChangeOrder_NumOfDaysToCompleteWork",
  "columnNameDataType": "VARCHAR(100)",
  "columnValueDataType" : "INTEGER",
  "required": true,
  "referencedTableID": "referencedTableID",
  "referencedTableIDDataType": "VARCHAR(100)",
  "referencedColumnName": "referencedColumnName",
  "referencedColumnNameDataType": "VARCHAR(100)",
  "referencedColumnRequired": false
},
{
  "_id": "PTCS_ContractChangeOrder_ProjectOrderNo",
  "_idDataType": "VARCHAR(100)",
  "tableID": "PT_ContractChangeOrder",
  "tableIDDataType": "VARCHAR(100)",

```



```

"columnName": "PTCS_ContractChangeOrder_ProjectOrderNo",
"columnNameDataType": "VARCHAR(100)",
"columnValueDataType" : "VARCHAR(9)",
"required": true,
"referencedTableID": "referencedTableID",
"referencedTableIDDataType": "VARCHAR(100)",
"referencedColumnName": "referencedColumnName",
"referencedColumnNameDataType": "VARCHAR(100)",
"referencedColumnRequired": false
},
{
  "_id": "PTCS_ContractChangeOrderMemo_ProjectCode",
  "_idDataType": "VARCHAR(100)",
  "tableID": "PT_ContractChangeOrderMemo",
  "tableIDDataType": "VARCHAR(100)",
  "columnName": "PTCS_ContractChangeOrderMemo_ProjectCode",
  "columnNameDataType": "VARCHAR(100)",
  "columnValueDataType" : "VARCHAR(4)",
  "required": true,
  "referencedTableID": "referencedTableID",
  "referencedTableIDDataType": "VARCHAR(100)",
  "referencedColumnName": "referencedColumnName",
  "referencedColumnNameDataType": "VARCHAR(100)",
  "referencedColumnRequired": false
},
{
  "_id": "PTCS_ContractChangeOrderMemo_ProjectNo",
  "_idDataType": "VARCHAR(100)",
  "tableID": "PT_ContractChangeOrderMemo",

```

```

"tableIDDatatype": "VARCHAR(100)",
"columnName": "PTCS_ContractChangeOrderMemo_ProjectNo",
"columnNameDataType": "VARCHAR(100)",
"columnValueDataType" : "VARCHAR(4)",
"required": true,
"referencedTableID": "referencedTableID",
"referencedTableIDDatatype": "VARCHAR(100)",
"referencedColumnName": "referencedColumnName",
"referencedColumnNameDataType": "VARCHAR(100)",
"referencedColumnRequired": false
},
{
  "_id": "PTCS_ContractChangeOrderMemo_DocumentIdentifier",
  "_idDataType": "VARCHAR(100)",
  "tableID": "PT_ContractChangeOrderMemo",
  "tableIDDatatype": "VARCHAR(100)",
  "columnName": "PTCS_ContractChangeOrderMemo_DocumentIdentifier",
  "columnNameDataType": "VARCHAR(100)",
  "columnValueDataType" : "VARCHAR(30)",
  "required": true,
  "referencedTableID": "referencedTableID",
  "referencedTableIDDatatype": "VARCHAR(100)",
  "referencedColumnName": "referencedColumnName",
  "referencedColumnNameDataType": "VARCHAR(100)",
  "referencedColumnRequired": false
},
{
  "_id": "PTCS_ContractChangeOrderMemo_DocumentName",
  "_idDataType": "VARCHAR(100)",

```

```

"tableID": "PT_ContractChangeOrderMemo",
"tableIDDataType": "VARCHAR(100)",
"columnName": "PTCS_ContractChangeOrderMemo_DocumentName",
"columnNameDataType": "VARCHAR(100)",
"columnValueDataType" : "VARCHAR(30)",
"required": true,
"referencedTableID": "referencedTableID",
"referencedTableIDDataType": "VARCHAR(100)",
"referencedColumnName": "referencedColumnName",
"referencedColumnNameDataType": "VARCHAR(100)",
"referencedColumnRequired": false
},
{
  "_id": "PTCS_ContractChangeOrderMemo_FilePath",
  "_idDataType": "VARCHAR(100)",
  "tableID": "PT_ContractChangeOrderMemo",
  "tableIDDataType": "VARCHAR(100)",
  "columnName": "PTCS_ContractChangeOrderMemo_FilePath",
  "columnNameDataType": "VARCHAR(100)",
  "columnValueDataType" : "VARCHAR(100)",
  "required": true,
  "referencedTableID": "referencedTableID",
  "referencedTableIDDataType": "VARCHAR(100)",
  "referencedColumnName": "referencedColumnName",
  "referencedColumnNameDataType": "VARCHAR(100)",
  "referencedColumnRequired": false
},
{
  "_id": "PTCS_ContractChangeOrderMemo_MemoDate",

```

```

    "_idDataType": "VARCHAR(100)",
    "tableID": "PT_ContractChangeOrderMemo",
    "tableIDDataType": "VARCHAR(100)",
    "columnName": "PTCS_ContractChangeOrderMemo_MemoDate",
    "columnNameDataType": "VARCHAR(100)",
    "columnValueDataType" : "DATE",
    "required": true,
    "referencedTableID": "referencedTableID",
    "referencedTableIDDataType": "VARCHAR(100)",
    "referencedColumnName": "referencedColumnName",
    "referencedColumnNameDataType": "VARCHAR(100)",
    "referencedColumnRequired": false
  },
  {
    "_id": "PTCS_ContractChangeOrderMemo_Audience",
    "_idDataType": "VARCHAR(100)",
    "tableID": "PT_ContractChangeOrderMemo",
    "tableIDDataType": "VARCHAR(100)",
    "columnName": "PTCS_ContractChangeOrderMemo_Audience",
    "columnNameDataType": "VARCHAR(100)",
    "columnValueDataType" : "VARCHAR(50)",
    "required": true,
    "referencedTableID": "referencedTableID",
    "referencedTableIDDataType": "VARCHAR(100)",
    "referencedColumnName": "referencedColumnName",
    "referencedColumnNameDataType": "VARCHAR(100)",
    "referencedColumnRequired": false
  },
  {

```

```

    "_id": "PTCS_ContractChangeOrderMemo_Sender",
    "_idDataType": "VARCHAR(100)",
    "tableID": "PT_ContractChangeOrderMemo",
    "tableIDDataType": "VARCHAR(100)",
    "columnName": "PTCS_ContractChangeOrderMemo_Sender",
    "columnNameDataType": "VARCHAR(100)",
    "columnValueDataType" : "VARCHAR(50)",
    "required": true,
    "referencedTableID": "referencedTableID",
    "referencedTableIDDataType": "VARCHAR(100)",
    "referencedColumnName": "referencedColumnName",
    "referencedColumnNameDataType": "VARCHAR(100)",
    "referencedColumnRequired": false
  },
  {
    "_id": "PTCS_ContractChangeOrderMemo_Subject",
    "_idDataType": "VARCHAR(100)",
    "tableID": "PT_ContractChangeOrderMemo",
    "tableIDDataType": "VARCHAR(100)",
    "columnName": "PTCS_ContractChangeOrderMemo_Subject",
    "columnNameDataType": "VARCHAR(100)",
    "columnValueDataType" : "VARCHAR(100)",
    "required": true,
    "referencedTableID": "referencedTableID",
    "referencedTableIDDataType": "VARCHAR(100)",
    "referencedColumnName": "referencedColumnName",
    "referencedColumnNameDataType": "VARCHAR(100)",
    "referencedColumnRequired": false
  },

```

```

{
  "_id": "PTCS_ContractChangeOrderMemo_InReferenceTo",
  "_idDataType": "VARCHAR(100)",
  "tableID": "PT_ContractChangeOrderMemo",
  "tableIDDataType": "VARCHAR(100)",
  "columnName": "PTCS_ContractChangeOrderMemo_InReferenceTo",
  "columnNameDataType": "VARCHAR(100)",
  "columnValueDataType" : "VARCHAR(100)",
  "required": true,
  "referencedTableID": "referencedTableID",
  "referencedTableIDDataType": "VARCHAR(100)",
  "referencedColumnName": "referencedColumnName",
  "referencedColumnNameDataType": "VARCHAR(100)",
  "referencedColumnRequired": false
},
{
  "_id": "PTCS_ContractChangeOrderMemo_MemoBody",
  "_idDataType": "VARCHAR(100)",
  "tableID": "PT_ContractChangeOrderMemo",
  "tableIDDataType": "VARCHAR(100)",
  "columnName": "PTCS_ContractChangeOrderMemo_MemoBody",
  "columnNameDataType": "VARCHAR(100)",
  "columnValueDataType" : "VARCHAR(2000)",
  "required": true,
  "referencedTableID": "referencedTableID",
  "referencedTableIDDataType": "VARCHAR(100)",
  "referencedColumnName": "referencedColumnName",
  "referencedColumnNameDataType": "VARCHAR(100)",
  "referencedColumnRequired": false
}

```

```

},
{
  "_id": "PTCS_Drawing_DocumentIdentifier",
  "_idDataType": "VARCHAR(100)",
  "tableID": "PT_Drawing",
  "tableIDDataType": "VARCHAR(100)",
  "columnName": "PTCS_Drawing_DocumentIdentifier",
  "columnNameDataType": "VARCHAR(100)",
  "columnValueDataType" : "VARCHAR(30)",
  "required": true,
  "referencedTableID": "referencedTableID",
  "referencedTableIDDataType": "VARCHAR(100)",
  "referencedColumnName": "referencedColumnName",
  "referencedColumnNameDataType": "VARCHAR(100)",
  "referencedColumnRequired": false
},
{
  "_id": "PTCS_Drawing_ProjectCode",
  "_idDataType": "VARCHAR(100)",
  "tableID": "PT_Drawing",
  "tableIDDataType": "VARCHAR(100)",
  "columnName": "PTCS_Drawing_ProjectCode",
  "columnNameDataType": "VARCHAR(100)",
  "columnValueDataType" : "VARCHAR(4)",
  "required": true,
  "referencedTableID": "referencedTableID",
  "referencedTableIDDataType": "VARCHAR(100)",
  "referencedColumnName": "referencedColumnName",
  "referencedColumnNameDataType": "VARCHAR(100)",

```

```

    "referencedColumnRequired": false
  },
  {
    "_id": "PTCS_Drawing_ProjectNo",
    "_idDataType": "VARCHAR(100)",
    "tableID": "PT_Drawing",
    "tableIDDataType": "VARCHAR(100)",
    "columnName": "PTCS_Drawing_ProjectNo",
    "columnNameDataType": "VARCHAR(100)",
    "columnValueDataType" : "VARCHAR(4)",
    "required": true,
    "referencedTableID": "referencedTableID",
    "referencedTableIDDataType": "VARCHAR(100)",
    "referencedColumnName": "referencedColumnName",
    "referencedColumnNameDataType": "VARCHAR(100)",
    "referencedColumnRequired": false
  },
  {
    "_id": "PTCS_Drawing_DocumentName",
    "_idDataType": "VARCHAR(100)",
    "tableID": "PT_Drawing",
    "tableIDDataType": "VARCHAR(100)",
    "columnName": "PTCS_Drawing_DocumentName",
    "columnNameDataType": "VARCHAR(100)",
    "columnValueDataType" : "VARCHAR(30)",
    "required": true,
    "referencedTableID": "referencedTableID",
    "referencedTableIDDataType": "VARCHAR(100)",
    "referencedColumnName": "referencedColumnName",

```



```

    "referencedColumnNameDataType": "VARCHAR(100)",
    "referencedColumnRequired": false
  },
  {
    "_id": "PTCS_Drawing_FilePath",
    "_idDataType": "VARCHAR(100)",
    "tableID": "PT_Drawing",
    "tableIDDataType": "VARCHAR(100)",
    "columnName": "PTCS_Drawing_FilePath",
    "columnNameDataType": "VARCHAR(100)",
    "columnValueDataType" : "VARCHAR(100)",
    "required": true,
    "referencedTableID": "referencedTableID",
    "referencedTableIDDataType": "VARCHAR(100)",
    "referencedColumnName": "referencedColumnName",
    "referencedColumnNameDataType": "VARCHAR(100)",
    "referencedColumnRequired": false
  },
  {
    "_id": "PTCS_Drawing_SheetNumber",
    "_idDataType": "VARCHAR(100)",
    "tableID": "PT_Drawing",
    "tableIDDataType": "VARCHAR(100)",
    "columnName": "PTCS_Drawing_SheetNumber",
    "columnNameDataType": "VARCHAR(100)",
    "columnValueDataType" : "INTEGER",
    "required": true,
    "referencedTableID": "referencedTableID",
    "referencedTableIDDataType": "VARCHAR(100)",

```

```

    "referencedColumnName": "referencedColumnName",
    "referencedColumnNameDataType": "VARCHAR(100)",
    "referencedColumnRequired": false
  },
  {
    "_id": "PTCS_Drawing_HorizontalScale",
    "_idDataType": "VARCHAR(100)",
    "tableID": "PT_Drawing",
    "tableIDDataType": "VARCHAR(100)",
    "columnName": "PTCS_Drawing_HorizontalScale",
    "columnNameDataType": "VARCHAR(100)",
    "columnValueDataType" : "VARCHAR(15)",
    "required": true,
    "referencedTableID": "referencedTableID",
    "referencedTableIDDataType": "VARCHAR(100)",
    "referencedColumnName": "referencedColumnName",
    "referencedColumnNameDataType": "VARCHAR(100)",
    "referencedColumnRequired": false
  },
  {
    "_id": "PTCS_Drawing_VerticalScale",
    "_idDataType": "VARCHAR(100)",
    "tableID": "PT_Drawing",
    "tableIDDataType": "VARCHAR(100)",
    "columnName": "PTCS_Drawing_VerticalScale",
    "columnNameDataType": "VARCHAR(100)",
    "columnValueDataType" : "VARCHAR(15)",
    "required": true,
    "referencedTableID": "referencedTableID",

```

```

"referencedTableIDDataType": "VARCHAR(100)",
"referencedColumnName": "referencedColumnName",
"referencedColumnNameDataType": "VARCHAR(100)",
"referencedColumnRequired": false
},
{
  "_id": "PTCS_Contractor_ContractorID",
  "_idDataType": "VARCHAR(100)",
  "tableID": "SPT_Contractor",
  "tableIDDataType": "VARCHAR(100)",
  "columnName": "PTCS_Contractor_ContractorID",
  "columnNameDataType": "VARCHAR(100)",
  "columnValueDataType" : "VARCHAR(15)",
  "required": true,
  "referencedTableID": "referencedTableID",
  "referencedTableIDDataType": "VARCHAR(100)",
  "referencedColumnName": "referencedColumnName",
  "referencedColumnNameDataType": "VARCHAR(100)",
  "referencedColumnRequired": false
},
{
  "_id": "PTCS_Contractor_ContractorStreetAddress",
  "_idDataType": "VARCHAR(100)",
  "tableID": "SPT_Contractor",
  "tableIDDataType": "VARCHAR(100)",
  "columnName": "PTCS_Contractor_ContractorStreetAddress",
  "columnNameDataType": "VARCHAR(100)",
  "columnValueDataType" : "VARCHAR(50)",
  "required": true,

```

```

"referencedTableID": "referencedTableID",
"referencedTableIDDataType": "VARCHAR(100)",
"referencedColumnName": "referencedColumnName",
"referencedColumnNameDataType": "VARCHAR(100)",
"referencedColumnRequired": false
},
{
  "_id": "PTCS_Contractor_ContractorCity",
  "_idDataType": "VARCHAR(100)",
  "tableID": "SPT_Contractor",
  "tableIDDataType": "VARCHAR(100)",
  "columnName": "PTCS_Contractor_ContractorCity",
  "columnNameDataType": "VARCHAR(100)",
  "columnValueDataType" : "VARCHAR(50)",
  "required": true,
  "referencedTableID": "referencedTableID",
  "referencedTableIDDataType": "VARCHAR(100)",
  "referencedColumnName": "referencedColumnName",
  "referencedColumnNameDataType": "VARCHAR(100)",
  "referencedColumnRequired": false
},
{
  "_id": "PTCS_Contractor_ContractorState",
  "_idDataType": "VARCHAR(100)",
  "tableID": "SPT_Contractor",
  "tableIDDataType": "VARCHAR(100)",
  "columnName": "PTCS_Contractor_ContractorState",
  "columnNameDataType": "VARCHAR(100)",
  "columnValueDataType" : "CHAR(2)",

```

```

"required": true,
"referencedTableID": "referencedTableID",
"referencedTableIDDataType": "VARCHAR(100)",
"referencedColumnName": "referencedColumnName",
"referencedColumnNameDataType": "VARCHAR(100)",
"referencedColumnRequired": false
},
{
  "_id": "PTCS_Contractor_ContractorZipCode",
  "_idDataType": "VARCHAR(100)",
  "tableID": "SPT_Contractor",
  "tableIDDataType": "VARCHAR(100)",
  "columnName": "PTCS_Contractor_ContractorZipCode",
  "columnNameDataType": "VARCHAR(100)",
  "columnValueDataType" : "CHAR(5)",
  "required": true,
  "referencedTableID": "referencedTableID",
  "referencedTableIDDataType": "VARCHAR(100)",
  "referencedColumnName": "referencedColumnName",
  "referencedColumnNameDataType": "VARCHAR(100)",
  "referencedColumnRequired": false
}
]

```

D.5 Schema.table.columns.complex

```

[
{
  "_id": "PTCC_Drawing_DrawingSignoff",
  "_idDataType": "VARCHAR(100)",

```

```

"tableID": "PT_Drawing",
"tableIDDataType": "VARCHAR(100)",
"columnName": "PTCC_Drawing_DrawingSignoff",
"columnNameDataType": "VARCHAR(100)",
"required": false,
"minOccurrences": "0",
"maxOccurrences": "UNBOUNDED",
"parentColumn": {
  "required": false,
  "parentColumnID": "parentColumnID",
  "parentColumnIDDataType": "VARCHAR(100)"
},
"columnAttributes": [
  {
    "codeEnforcedPrimaryKey": true,
    "columnAttributeName": "phase",
    "columnAttributeNameDataType": "VARCHAR(100)",
    "columnAttributeDataType": "VARCHAR(20)",
    "columnAttributeRequired": true,
    "referencedTableID": "referencedTableID",
    "referencedTableIDDataType": "VARCHAR(100)",
    "referencedColumnName": "referencedColumnName",
    "referencedColumnNameDataType": "VARCHAR(100)",
    "referencedColumnRequired": false
  },
  {
    "codeEnforcedPrimaryKey": false,
    "columnAttributeName": "designerInitials",
    "columnAttributeNameDataType": "VARCHAR(100)",

```

```

"columnAttributeDataType": "VARCHAR(3)",
"columnAttributeRequired": true,
"referencedTableID": "referencedTableID",
"referencedTableIDDataType": "VARCHAR(100)",
"referencedColumnName": "referencedColumnName",
"referencedColumnNameDataType": "VARCHAR(100)",
"referencedColumnRequired": false
},
{
"codeEnforcedPrimaryKey": false,
"columnAttributeName": "checkerName",
"columnAttributeNameDataType": "VARCHAR(100)",
"columnAttributeDataType": "VARCHAR(50)",
"columnAttributeRequired": true,
"referencedTableID": "referencedTableID",
"referencedTableIDDataType": "VARCHAR(100)",
"referencedColumnName": "referencedColumnName",
"referencedColumnNameDataType": "VARCHAR(100)",
"referencedColumnRequired": false
},
{
"codeEnforcedPrimaryKey": false,
"columnAttributeName": "checkedDate",
"columnAttributeNameDataType": "VARCHAR(100)",
"columnAttributeDataType": "DATE",
"columnAttributeRequired": true,
"referencedTableID": "referencedTableID",
"referencedTableIDDataType": "VARCHAR(100)",
"referencedColumnName": "referencedColumnName",

```

```

    "referencedColumnNameDataType": "VARCHAR(100)",
    "referencedColumnRequired": false
  },
  {
    "codeEnforcedPrimaryKey": false,
    "columnAttributeName": "designedDate",
    "columnAttributeNameDataType": "VARCHAR(100)",
    "columnAttributeDataType": "DATE",
    "columnAttributeRequired": true,
    "referencedTableID": "referencedTableID",
    "referencedTableIDDataType": "VARCHAR(100)",
    "referencedColumnName": "referencedColumnName",
    "referencedColumnNameDataType": "VARCHAR(100)",
    "referencedColumnRequired": false
  }
],
"childComplexColumns": {
  "required": false,
  "minOccurrences": "0",
  "maxOccurrences": "UNBOUNDED",
  "childComplexColumnID": "childColumnID",
  "childComplexColumnIDDataType": "VARCHAR(100)"
}
},
{
  "_id": "PTCC_Drawing_RevisionHistory",
  "_idDataType": "VARCHAR(100)",
  "tableID": "PT_Drawing",
  "tableIDDataType": "VARCHAR(100)",

```



```

"columnName": "PTCC_Drawing_RevisionHistory",
"columnNameDataType": "VARCHAR(100)",
"required": false,
"minOccurrences": "0",
"maxOccurrences": "UNBOUNDED",
"parentColumn": {
  "required": false,
  "parentColumnID": "parentColumnID",
  "parentColumnIDDataType": "VARCHAR(100)"
},
"columnAttributes": [
  {
    "codeEnforcedPrimaryKey": true,
    "columnAttributeName": "revisionDate",
    "columnAttributeNameDataType": "VARCHAR(100)",
    "columnAttributeDataType": "DATE",
    "columnAttributeRequired": true,
    "referencedTableID": "referencedTableID",
    "referencedTableIDDataType": "VARCHAR(100)",
    "referencedColumnName": "referencedColumnName",
    "referencedColumnNameDataType": "VARCHAR(100)",
    "referencedColumnRequired": false
  },
  {
    "codeEnforcedPrimaryKey": false,
    "columnAttributeName": "comments",
    "columnAttributeNameDataType": "VARCHAR(100)",
    "columnAttributeDataType": "VARCHAR(200)",
    "columnAttributeRequired": true,

```

```

    "referencedTableID": "referencedTableID",
    "referencedTableIDDataType": "VARCHAR(100)",
    "referencedColumnName": "referencedColumnName",
    "referencedColumnNameDataType": "VARCHAR(100)",
    "referencedColumnRequired": false
  },
  {
    "codeEnforcedPrimaryKey": false,
    "columnAttributeName": "revisedByInitials",
    "columnAttributeNameDataType": "VARCHAR(100)",
    "columnAttributeDataType": "VARCHAR(3)",
    "columnAttributeRequired": true,
    "referencedTableID": "referencedTableID",
    "referencedTableIDDataType": "VARCHAR(100)",
    "referencedColumnName": "referencedColumnName",
    "referencedColumnNameDataType": "VARCHAR(100)",
    "referencedColumnRequired": false
  }
],
"childComplexColumns": {
  "required": false,
  "minOccurrences": "0",
  "maxOccurrences": "UNBOUNDED",
  "childComplexColumnID": "childColumnID",
  "childComplexColumnIDDataType": "VARCHAR(100)"
}
},
{
  "_id": "PTCC_Drawing_DrawingIndex",

```

```

"_idDataType": "VARCHAR(100)",
"tableID": "PT_Drawing",
"tableIDDataType": "VARCHAR(100)",
"columnName": "PTCC_Drawing_DrawingIndex",
"columnNameDataType": "VARCHAR(100)",
"required": false,
"minOccurrences": "0",
"maxOccurrences": "UNBOUNDED",
"parentColumn": {
  "required": false,
  "parentColumnID": "parentColumnID",
  "parentColumnIDDataType": "VARCHAR(100)"
},
"columnAttributes": [
  {
    "codeEnforcedPrimaryKey": true,
    "columnAttributeName": "drawingIndexIdentifier",
    "columnAttributeNameDataType": "VARCHAR(100)",
    "columnAttributeDataType": "VARCHAR(20)",
    "columnAttributeRequired": true,
    "referencedTableID": "referencedTableID",
    "referencedTableIDDataType": "VARCHAR(100)",
    "referencedColumnName": "referencedColumnName",
    "referencedColumnNameDataType": "VARCHAR(100)",
    "referencedColumnRequired": false
  },
  {
    "codeEnforcedPrimaryKey": false,
    "columnAttributeName": "designerName",

```

```

"columnAttributeNameDataType": "VARCHAR(100)",
"columnAttributeDataType": "VARCHAR(50)",
"columnAttributeRequired": true,
"referencedTableID": "referencedTableID",
"referencedTableIDDataType": "VARCHAR(100)",
"referencedColumnName": "referencedColumnName",
"referencedColumnNameDataType": "VARCHAR(100)",
"referencedColumnRequired": false
},
{
"codeEnforcedPrimaryKey": false,
"columnAttributeName": "detailerName",
"columnAttributeNameDataType": "VARCHAR(100)",
"columnAttributeDataType": "VARCHAR(50)",
"columnAttributeRequired": true,
"referencedTableID": "referencedTableID",
"referencedTableIDDataType": "VARCHAR(100)",
"referencedColumnName": "referencedColumnName",
"referencedColumnNameDataType": "VARCHAR(100)",
"referencedColumnRequired": false
},
{
"codeEnforcedPrimaryKey": false,
"columnAttributeName": "sheetSubset",
"columnAttributeNameDataType": "VARCHAR(100)",
"columnAttributeDataType": "VARCHAR(20)",
"columnAttributeRequired": true,
"referencedTableID": "referencedTableID",
"referencedTableIDDataType": "VARCHAR(100)",

```

```

    "referencedColumnName": "referencedColumnName",
    "referencedColumnNameDataType": "VARCHAR(100)",
    "referencedColumnRequired": false
  },
  {
    "codeEnforcedPrimaryKey": false,
    "columnAttributeName": "subsetSheets",
    "columnAttributeNameDataType": "VARCHAR(100)",
    "columnAttributeDataType": "INTEGER",
    "columnAttributeRequired": true,
    "referencedTableID": "referencedTableID",
    "referencedTableIDDataType": "VARCHAR(100)",
    "referencedColumnName": "referencedColumnName",
    "referencedColumnNameDataType": "VARCHAR(100)",
    "referencedColumnRequired": false
  },
  {
    "codeEnforcedPrimaryKey": false,
    "columnAttributeName": "structureNumberStart",
    "columnAttributeNameDataType": "VARCHAR(100)",
    "columnAttributeDataType": "CHAR(7)",
    "columnAttributeRequired": true,
    "referencedTableID": "referencedTableID",
    "referencedTableIDDataType": "VARCHAR(100)",
    "referencedColumnName": "referencedColumnName",
    "referencedColumnNameDataType": "VARCHAR(100)",
    "referencedColumnRequired": false
  },
  {

```

```

    "codeEnforcedPrimaryKey": false,
    "columnAttributeName": "structureNumberEnd",
    "columnAttributeNameDataType": "VARCHAR(100)",
    "columnAttributeDataType": "CHAR(7)",
    "columnAttributeRequired": true,
    "referencedTableID": "referencedTableID",
    "referencedTableIDDataType": "VARCHAR(100)",
    "referencedColumnName": "referencedColumnName",
    "referencedColumnNameDataType": "VARCHAR(100)",
    "referencedColumnRequired": false
  }
],
"childComplexColumns": {
  "required": false,
  "minOccurrences": "0",
  "maxOccurrences": "UNBOUNDED",
  "childComplexColumnID": "childColumnID",
  "childComplexColumnIDDataType": "VARCHAR(100)"
}
},
{
  "_id": "PTCC_ContractChangeOrder_LineItem",
  "_idDataType": "VARCHAR(100)",
  "tableID": "PT_ContractChangeOrder",
  "tableIDDataType": "VARCHAR(100)",
  "columnName": "PTCC_ContractChangeOrder_LineItem",
  "columnNameDataType": "VARCHAR(100)",
  "required": false,
  "minOccurrences": "0",

```

```

"maxOccurrences": "UNBOUNDED",
"parentColumn": {
  "required": false,
  "parentColumnID": "parentColumnID",
  "parentColumnIDDataType": "VARCHAR(100)"
},
"columnAttributes": [
  {
    "codeEnforcedPrimaryKey": true,
    "columnAttributeName": "lineItemIdentifier",
    "columnAttributeNameDataType": "VARCHAR(100)",
    "columnAttributeDataType": "VARCHAR(15)",
    "columnAttributeRequired": true,
    "referencedTableID": "referencedTableID",
    "referencedTableIDDataType": "VARCHAR(100)",
    "referencedColumnName": "referencedColumnName",
    "referencedColumnNameDataType": "VARCHAR(100)",
    "referencedColumnRequired": false
  },
  {
    "codeEnforcedPrimaryKey": false,
    "columnAttributeName": "itemDescription",
    "columnAttributeNameDataType": "VARCHAR(100)",
    "columnAttributeDataType": "VARCHAR(50)",
    "columnAttributeRequired": true,
    "referencedTableID": "referencedTableID",
    "referencedTableIDDataType": "VARCHAR(100)",
    "referencedColumnName": "referencedColumnName",
    "referencedColumnNameDataType": "VARCHAR(100)",
  }
]

```

```

    "referencedColumnRequired": false
  },
  {
    "codeEnforcedPrimaryKey": false,
    "columnAttributeName": "unitOfMeasure",
    "columnAttributeNameDataType": "VARCHAR(100)",
    "columnAttributeDataType": "VARCHAR(10)",
    "columnAttributeRequired": true,
    "referencedTableID": "referencedTableID",
    "referencedTableIDDataType": "VARCHAR(100)",
    "referencedColumnName": "referencedColumnName",
    "referencedColumnNameDataType": "VARCHAR(100)",
    "referencedColumnRequired": false
  },
  {
    "codeEnforcedPrimaryKey": false,
    "columnAttributeName": "previousQuantity",
    "columnAttributeNameDataType": "VARCHAR(100)",
    "columnAttributeDataType": "DECIMAL(8,2)",
    "columnAttributeRequired": true,
    "referencedTableID": "referencedTableID",
    "referencedTableIDDataType": "VARCHAR(100)",
    "referencedColumnName": "referencedColumnName",
    "referencedColumnNameDataType": "VARCHAR(100)",
    "referencedColumnRequired": false
  },
  {
    "codeEnforcedPrimaryKey": false,
    "columnAttributeName": "addedQuantity",

```



```

"columnAttributeNameDataType": "VARCHAR(100)",
"columnAttributeDataType": "DECIMAL(8,2)",
"columnAttributeRequired": true,
"referencedTableID": "referencedTableID",
"referencedTableIDDataType": "VARCHAR(100)",
"referencedColumnName": "referencedColumnName",
"referencedColumnNameDataType": "VARCHAR(100)",
"referencedColumnRequired": false
},
{
"codeEnforcedPrimaryKey": false,
"columnAttributeName": "revisionPlanQuantity",
"columnAttributeNameDataType": "VARCHAR(100)",
"columnAttributeDataType": "DECIMAL(8,2)",
"columnAttributeRequired": true,
"referencedTableID": "referencedTableID",
"referencedTableIDDataType": "VARCHAR(100)",
"referencedColumnName": "referencedColumnName",
"referencedColumnNameDataType": "VARCHAR(100)",
"referencedColumnRequired": false
},
{
"codeEnforcedPrimaryKey": false,
"columnAttributeName": "unitPrice",
"columnAttributeNameDataType": "VARCHAR(100)",
"columnAttributeDataType": "DECIMAL(8,2)",
"columnAttributeRequired": true,
"referencedTableID": "referencedTableID",
"referencedTableIDDataType": "VARCHAR(100)",

```

```

        "referencedColumnName": "referencedColumnName",
        "referencedColumnNameDataType": "VARCHAR(100)",
        "referencedColumnRequired": false
    },
    {
        "codeEnforcedPrimaryKey": false,
        "columnAttributeName": "changeType",
        "columnAttributeNameDataType": "VARCHAR(100)",
        "columnAttributeDataType": "CHAR(1)",
        "columnAttributeRequired": true,
        "referencedTableID": "referencedTableID",
        "referencedTableIDDataType": "VARCHAR(100)",
        "referencedColumnName": "referencedColumnName",
        "referencedColumnNameDataType": "VARCHAR(100)",
        "referencedColumnRequired": false
    }
],
"childComplexColumns": {
    "required": false,
    "minOccurrences": "0",
    "maxOccurrences": "UNBOUNDED",
    "childComplexColumnID": "childColumnID",
    "childComplexColumnIDDataType": "VARCHAR(100)"
}
},
{
    "_id": "PTCC_ContractChangeOrder_Authorization",
    "_idDataType": "VARCHAR(100)",
    "tableID": "PT_ContractChangeOrder",

```

```

"tableIDDatatype": "VARCHAR(100)",
"columnName": "PTCC_ContractChangeOrder_Authorization",
"columnNameDataType": "VARCHAR(100)",
"required": false,
"minOccurrences": "0",
"maxOccurrences": "UNBOUNDED",
"parentColumn": {
  "required": false,
  "parentColumnID": "parentColumnID",
  "parentColumnIDDatatype": "VARCHAR(100)"
},
"columnAttributes": [
  {
    "codeEnforcedPrimaryKey": true,
    "columnAttributeName": "authorizationIdentifier",
    "columnAttributeNameDataType": "VARCHAR(100)",
    "columnAttributeDataType": "VARCHAR(15)",
    "columnAttributeRequired": true,
    "referencedTableID": "referencedTableID",
    "referencedTableIDDatatype": "VARCHAR(100)",
    "referencedColumnName": "referencedColumnName",
    "referencedColumnNameDataType": "VARCHAR(100)",
    "referencedColumnRequired": false
  },
  {
    "codeEnforcedPrimaryKey": false,
    "columnAttributeName": "roleName",
    "columnAttributeNameDataType": "VARCHAR(100)",
    "columnAttributeDataType": "VARCHAR(50)",

```

```
"columnAttributeRequired": true,
"referencedTableID": "referencedTableID",
"referencedTableIDDataType": "VARCHAR(100)",
"referencedColumnName": "referencedColumnName",
"referencedColumnNameDataType": "VARCHAR(100)",
"referencedColumnRequired": false
},
{
"codeEnforcedPrimaryKey": false,
"columnAttributeName": "authorizerName",
"columnAttributeNameDataType": "VARCHAR(100)",
"columnAttributeDataType": "VARCHAR(50)",
"columnAttributeRequired": true,
"referencedTableID": "referencedTableID",
"referencedTableIDDataType": "VARCHAR(100)",
"referencedColumnName": "referencedColumnName",
"referencedColumnNameDataType": "VARCHAR(100)",
"referencedColumnRequired": false
},
{
"codeEnforcedPrimaryKey": false,
"columnAttributeName": "authorizationDate",
"columnAttributeNameDataType": "VARCHAR(100)",
"columnAttributeDataType": "DATE",
"columnAttributeRequired": true,
"referencedTableID": "referencedTableID",
"referencedTableIDDataType": "VARCHAR(100)",
"referencedColumnName": "referencedColumnName",
"referencedColumnNameDataType": "VARCHAR(100)",
```

```

        "referencedColumnRequired": false
    }
],
"childComplexColumns": {
    "required": false,
    "minOccurrences": "0",
    "maxOccurrences": "UNBOUNDED",
    "childComplexColumnID": "childColumnID",
    "childComplexColumnIDDataType": "VARCHAR(100)"
}
}
]

```

D.6 PT_Project

```

[
{
    "_id": "Project-1",
    "tableID": "PT_Project",
    "PTCS_Project_ProjectCode": "PRJ1",
    "PTCS_Project_ProjectNo": "0001",
    "OC_Documents": {
        "childTables": [
            {
                "childTable": "ChangeOrder-1"
            },
            {
                "childTable": "DRAW-1"
            }
        ]
    }
}
]

```

```

    }
  }
]

```

D.7 PT_Drawing

```

[
{
  "_id": "DRAW-1",
  "PTCS_Drawing_DocumentIdentifier": "DRAW-1",
  "PTCS_Drawing_ProjectCode": "PRJ1",
  "PTCS_Drawing_ProjectNo": "0001",
  "PTCS_Drawing_SheetNumber": 202,
  "PTCS_Drawing_HorizontalScale": "NTS",
  "PTCS_Drawing_VerticalScale": "As Noted",
  "PTCS_Drawing_DocumentName": "Sheet_B-INDEX-1.dgn",
  "PTCS_Drawing_FilePath": "\\drawings",
  "PTCC_Drawing_RevisionHistory": {
    "columnAttributes": [
      {
        "revisionDate": "11/1/2002",
        "comments": "Added the bridge support structures.",
        "revisedByInitials": "JBB"
      },
      {
        "revisionDate": "11/5/2002",
        "comments": "Removed the second pillar from the west side.",
        "revisedByInitials": "JBB"
      },
      {

```

```
    "revisionDate": "12/1/2002",
    "comments": "Changed the direction of the cross beams on second level.",
    "revisedByInitials": "GRA"
  }
]
},
"PTCC_Drawing_DrawingSignoff": {
  "columnAttributes": [
    {
      "phase": "Design",
      "checkerName": "Phil Brown",
      "checkedDate": "11/6/2002",
      "designerInitials": "JBB",
      "designedDate": "11/5/2002"
    },
    {
      "phase": "Detail",
      "checkerName": "Alice Smitherson",
      "checkedDate": "12/20/2002",
      "designerInitials": "JBB",
      "designedDate": "11/5/2002"
    },
    {
      "phase": "Design II",
      "checkerName": "Phil Brown",
      "checkedDate": "12/31/2002",
      "designerInitials": "ARB",
      "designedDate": "12/22/2002"
    }
  ]
}
```

```

]
},
"PTCC_Drawing_DrawingIndex": {
  "columnAttributes": [
    {
      "designerName": "Jeff Blank",
      "detailerName": "Bailey Smith",
      "sheetSubset": "Bridge",
      "subsetSheets": 2,
      "structureNumberStart": "1-01-01",
      "structureNumberEnd": "4-04-04"
    }
  ]
}
}
]

```

D.8 PT_ContractChangeOrderMemo

```

[
{
  "PTCS_ContractChangeOrderMemo_DocumentIdentifier": "MEMO-1",
  "PTCS_ContractChangeOrderMemo_DocumentName": "Route 111 Memo 1",
  "PTCS_ContractChangeOrderMemo_FilePath": "\\memo",
  "PTCS_ContractChangeOrderMemo_ProjectCode": "PRJ1",
  "PTCS_ContractChangeOrderMemo_ProjectNo": "0001",
  "PTCS_ContractChangeOrderMemo_MemoDate": "10/16/2001",
  "PTCS_ContractChangeOrderMemo_Audience": "Resident Engineer or Program Engineer",
  "PTCS_ContractChangeOrderMemo_Sender": "Project Engineer",

```



```

    "PTCS_ContractChangeOrderMemo_Subject": "Contract Modification Order #11, Right-of-Way Agreement-Fence Change",
    "PTCS_ContractChangeOrderMemo_InReferenceTo": "11111 /NH 66-063 Route 66 - East",
    "PTCS_ContractChangeOrderMemo_MemoBody": "The Right-of-way Agreement with the owners of Parcel 46 required that Fence Combination Wire be placed between Right-of-Way Point 165 and Right-of-Way Point 166."
},
{
    "PTCS_ContractChangeOrderMemo_DocumentIdentifier": "MEMO-2",
    "PTCS_ContractChangeOrderMemo_DocumentName": "Route 111 Memo 2",
    "PTCS_ContractChangeOrderMemo_FilePath": "\\memo",
    "PTCS_ContractChangeOrderMemo_ProjectCode": "PRJ1",
    "PTCS_ContractChangeOrderMemo_ProjectNo": "0001",
    "PTCS_ContractChangeOrderMemo_MemoDate": "10/27/2001",
    "PTCS_ContractChangeOrderMemo_Audience": "Resident Engineer",
    "PTCS_ContractChangeOrderMemo_Sender": "Project Engineer",
    "PTCS_ContractChangeOrderMemo_Subject": "Contract Modification Order #43, Concrete Change",
    "PTCS_ContractChangeOrderMemo_InReferenceTo": "222 /NH 70-051 Route 66 - West",
    "PTCS_ContractChangeOrderMemo_MemoBody": "The current concrete mixture must be change to support the weight of the heavy machinery for the upcoming year's project."
}
]

```

D.9 SPT_Contractor

```

[
{
    "_id": "CONTRACTOR-1",
    "tableID": "SPT_Contractor",
    "PTCS_Contractor_ContractorID": "CONTRACTOR-1",
    "PTCS_Contractor_ContractorStreetAddress": "12 Allensmith Drive",
    "PTCS_Contractor_ContractorCity": "Charlotte",

```

```

    "PTCS_Contractor_ContractorState": "NC",
    "PTCS_Contractor_ContractorZipCode": "28217"
  }
]

```

D.10 PT_ContractChangeOrder

```

[
  {
    "_id": "ChangeOrder-1",
    "PTCS_ContractChangeOrder_DocumentIdentifier": "ChangeOrder-1",
    "PTCS_ContractChangeOrder_DocumentName": "ChangeOrder1.pdf",
    "PTCS_ContractChangeOrder_FilePath": "\\changeorder",
    "PTCS_ContractChangeOrder_ProjectCode": "PRJ1",
    "PTCS_ContractChangeOrder_ProjectNo": "0001",
    "PTCS_ContractChangeOrder_ContractModificationTitle": "Row Agreement-Fence Change",
    "PTCS_ContractChangeOrder_MemoText": "Your contract is hereby modified to include Fence Wire
between Right-of-Way Point 165 and Righ-of-Way Point 166",
    "PTCS_ContractChangeOrder_ContractorID": "CONTRACTOR-1",
    "PTCS_ContractChangeOrder_Location": "Route 66-South",
    "PTCS_ContractChangeOrder_ChangeOrderDate": "9/30/2002",
    "PTCS_ContractChangeOrder_ProjectOrderNo": "NH 77-077",
    "PTCS_ContractChangeOrder_CostChangeIndicator": "A",
    "PTCS_ContractChangeOrder_CostChangeAmount": 3000.00,
    "PTCS_ContractChangeOrder_NumOfDaysToCompleetWork": 4,
    "PTCC_ContractChangeOrder_ContractChangeOrderAuthorization": {
      "columnAttributes": [
        {
          "authorizationIdentifier": "AUTH-1",
          "roleName": "FWHA Operations Engineer",

```

```

    "authorizerName": "Bill R Pepper",
    "authorizationDate": "10/1/2002"
  },
  {
    "authorizationIdentifier": "AUTH-2",
    "roleName": "Region Transportation Director",
    "authorizerName": "Kelly J Brinkley",
    "authorizationDate": "10/2/2002"
  }
]
},
"PTCC_ContractChangeOrder_LineItem": {
  "columnAttributes": [
    {
      "lineItemIdentifier": "LINEITEM-1",
      "itemDescription": "607 Fence Comb Wire w/Metail Posts",
      "unitOfMeasure": "LF",
      "previousQuantity": 0.00,
      "addedQuantity": 500.00,
      "revisionPlanQuantity": 500.00,
      "unitPrice": 6.00,
      "changeType": "A"
    },
    {
      "lineItemIdentifier": "LINEITEM-2",
      "itemDescription": "607 Fence Comb Wire w/Metail Posts",
      "unitOfMeasure": "LF",
      "previousQuantity": 5000.00,
      "addedQuantity": -500.00,

```

```
    "revisionPlanQuantity": 4500.00,  
    "unitPrice": 5.50,  
    "changeType": "D"  
  }  
]  
}  
]  
]
```

APPENDIX E

SUPPLEMENTAL MODELING DIAGRAMS

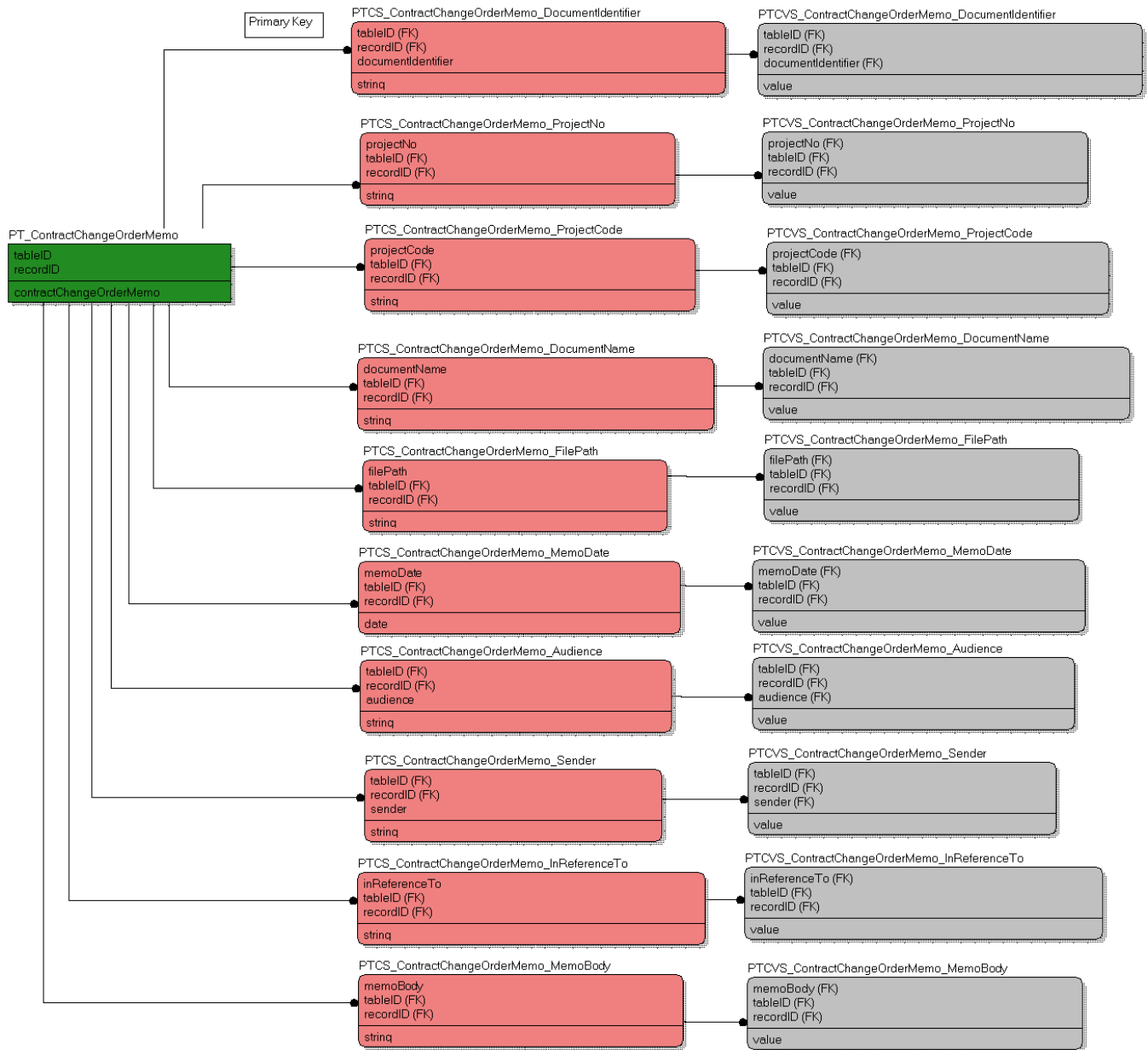

Figure 29 Logical Model - PT_ContractChangeOrderMemo

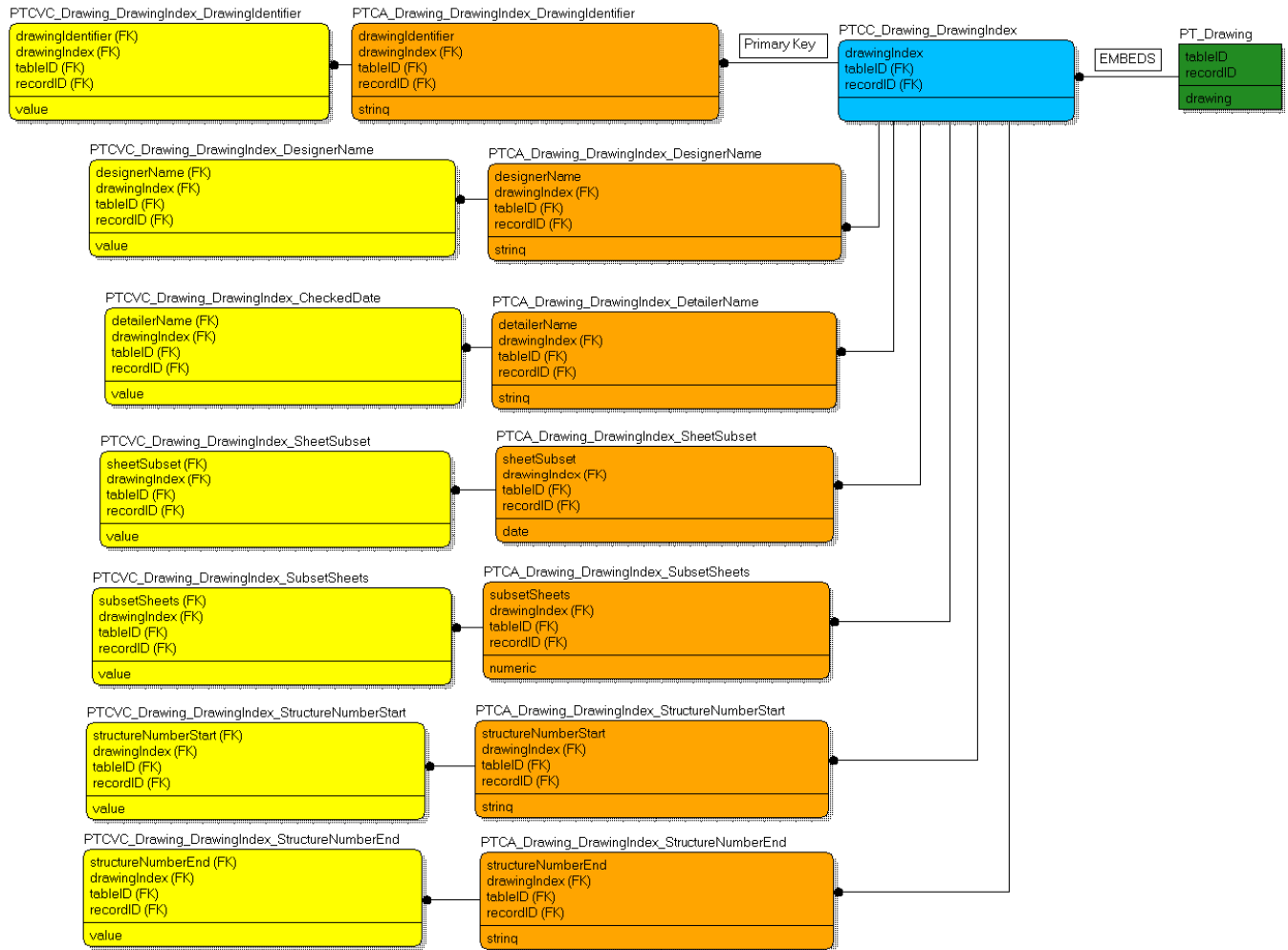

Figure 30 Logical Model – PTCC_Drawing_DrawingIndex

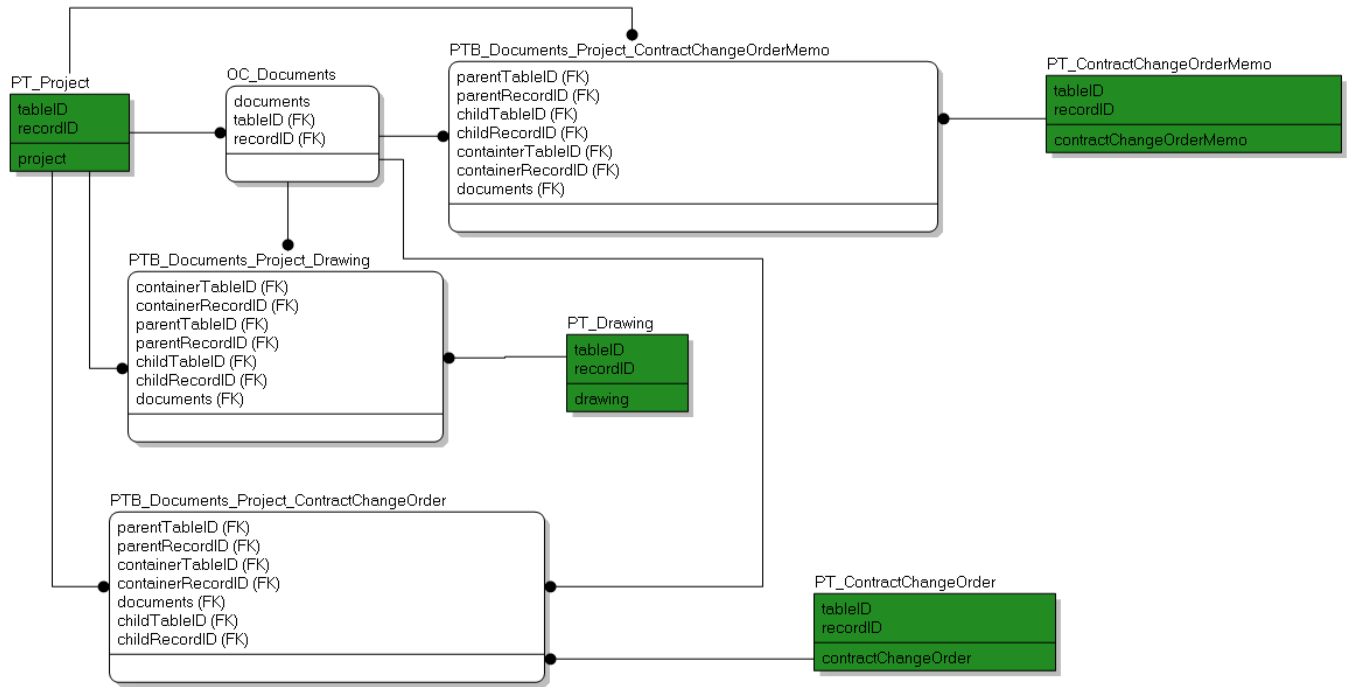

Figure 31 Logical Model – OC diagram